

Chapter- Current electricity

CURRENT ELECTRICITY

The branch of physics which deals with the charge in motion is called current electricity.

ELECTRIC CURRENT :

The strength of the electric current in a conductor is defined as the rate of flow of charge across any cross-section of the conductor.

- Average current flowing through a cross-section in an interval is $I_{av} = \frac{\Delta q}{\Delta t}$

Where Δq = the charge flowing through a cross-section in time Δt

- The current flowing through a cross-section at an instant t is ; $I = \lim_{\Delta t \rightarrow 0} \frac{\Delta q}{\Delta t} = \frac{dq}{dt}$

Where dq is the small amount of charge flowing in the conductor in a small-time dt

- So total charge flowing through a cross-section in a time t is; $q = \int_0^t Idt$

- For steady current ; $q = It$

- **Units of Electric Current:** In S.I. system the unit of current is **ampere (A)**.

$$1 \text{ ampere} = \frac{1 \text{ coulomb}}{1 \text{ second}}$$

- **Direction of Current:**

By convention, the direction of flow of current is taken to be the direction of the flow of positive charge. The flow of +ve charge is called **conventional current**. The flow of electrons

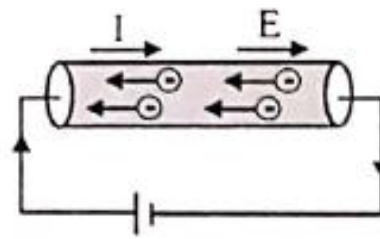
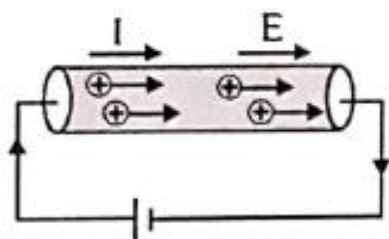

is called **electronic current** (opposite to conventional current).

- Current is a scalar quantity.
- Current is a fundamental quantity in S.I. system. So its dimensional formula is $[M^0L^0T^0A^1]$
- If there are n particles per unit volume each carrying a charge q and moving with a velocity v then the average current through a cross-section of area A is ; $I = nqvA$
- If a charge q is moving in a circular path of radius r with a uniform speed v then equivalent current is $I = \frac{q}{T} = \frac{qv}{2\pi r}$

- **Charge carriers :**

In conductors, the current is carried by some particles called as charge carriers.

For metals, charge carriers are free electrons.

For semiconductors, charge carriers are free electrons and holes.

For electrolytes +ve and -ve ions are charge carriers.

Question 1 :

The amount of charge passed in time t through the cross-section of a wire is $Q(t) = At^2 + Bt + C$.

- (a) Write the dimensional formulae for A, B, and C
- (b) If the numerical values of A, B and C are 5, 3 and 1 respectively in SI units,
- (i) Find the value of the current at $t = 5$ s.
- (ii) Find the average current flowing through the cross-section in the interval 0 to 5 s

Solution :

$$(a), [A] = \left[\frac{Q}{t^2} \right] = \frac{T^1 A^1}{T^2} = M^0 L^0 T^{-1} A^1, [B] = \left[\frac{Q}{t} \right] = \frac{T^1 A^1}{T^1} = M^0 L^0 T^0 A^1 \text{ and } [C] = [Q] = M^0 L^0 T^1 A^1$$

$$(b) (i) I = \frac{dQ}{dt} = \frac{d}{dt}(5t^2 + 3t + 1) = 10t + 3 \text{ At any instant } t, \text{ At } t = 5s, I = 10 \times 5 + 3 = 53A$$

$$(ii) I_{av} = \frac{Q_{t=5s} - Q_{t=0s}}{5s - 0s} = \frac{(5 \times 5^2 + 3 \times 5 + 1) - (5 \times 0^2 + 3 \times 0 + 1)}{5 - 0} A = 28A$$

Question 2: The current through a wire depends on time as to $i = i_0 + \alpha t$ where $i_0 = 10$ A and $\alpha = 4$ A/s. Find the charge crossed through a section of the wire in 10 s and find the average current flowing in 10 s.

Solution: Given, $i = i_0 + \alpha t = 10 + 4t$

$$\therefore q = \int_0^{10} i dt = \int_0^{10} (10 + 4t) dt = \left[10t + 2t^2 \right]_0^{10} = 300C$$

$$\therefore I_{av} = \frac{300C}{10s} = 30A$$

Question 3: An electron moves in a circle of radius 10 cm with a constant speed of 4.0×10^6 m/s. Find the electric current at a point on the circle.

$$\text{Solution : } I = \frac{qv}{2\pi r} = \frac{1.6 \times 10^{-19} \times 4 \times 10^6}{2\pi \times 0.1} A = \frac{32}{\pi} \times 10^{-3} A$$

Current Density (\vec{J}) :

- **Definition:** Current density at any point inside a conductor is defined as the magnitude of current passing through an infinitesimal area at that point provided that the area is being held perpendicular to the direction of flow of charge.

It is denoted by \vec{J} . So current density is a vector quantity.

Its direction is along the direction of flow of +ve charge.

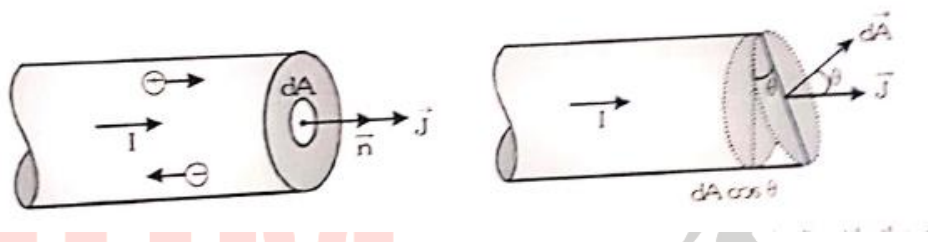

$$\therefore J = \frac{dI}{dA} \Rightarrow dI = JdA$$

Where dI = current flowing through a cross-section of area dA held perpendicular to the direction of the current.

- If the cross-section is held at an angle with the direction of flow of current then $dI = JdA \cos \theta = \vec{J} \cdot d\vec{A}$

So total current flowing through a surface is $I = \int \vec{J} \cdot d\vec{A}$

- If the steady current is flowing through a conductor of the uniform cross-section then both current and current density are constant at every point. In this case $I = JA \Rightarrow J = \frac{I}{A}$
- **S.I. Unit of Current Density:** Am^{-2} i.e. ampere (meter)⁻².
- **Dimensional formula :** $[M^0L^{-2}T^0A^1]$

Question 4: An electron beam has an aperture 1.0 mm^2 . A total of 6.0×10^{16} electrons go through any perpendicular cross-section per second. Find (i) the current (ii) current density in the beam.

Solution : (i) $I = \frac{q}{t} = \frac{Ne}{t} = \frac{6.0 \times 10^{16} \times 1.6 \times 10^{-19}}{1} \text{ A} = 9.6 \times 10^{-3} \text{ A} = 9.6 \text{ mA}$

(ii) $J = \frac{I}{A} = \frac{9.6 \times 10^{-3}}{10^{-6}} \text{ Am}^{-2} = 9.6 \times 10^3 \text{ Am}^{-2}$

Question 5: A steady current of 2 A flows through a conductor of the uniform circular cross-section of radius 2mm. Find

(i) The current density at any point inside the conductor

(ii) Total number of free electrons crossing a cross-section in 5 minutes.

Solution : (i) $J = \frac{I}{\pi r^2} = \frac{2 \text{ A}}{\pi (2 \times 10^{-3} \text{ m})^2} = \frac{10^6}{2\pi} \text{ Am}^{-2}$

(ii) $N = \frac{q}{e} = \frac{It}{e} = \frac{2 \text{ A} \times 5 \text{ min}}{1.6 \times 10^{-19} \text{ C}} = \frac{2 \text{ A} \times 300 \text{ s}}{1.6 \times 10^{-19} \text{ C}} = 3.75 \times 10^{21}$

Mechanism of current flow in a conductor :

- A metallic conductor contains a large number of free electrons and lattice ions.
- Due to thermal energy the lattice ions vibrate about their mean position and collide with free electrons. Just after a collision the electron move in a random direction. So the average of velocities of all electrons just after a collision with lattice ions is zero.
- The free electrons move along a **straight line** between two successive collisions **in the absence of an external electric field.**
- The time gap between two successive collisions of a free electron with lattice ions is called as **relaxation time.**
- The average of relaxation times of all free electrons is average relaxation time.

- When temperature increases the lattice ions vibrate with greater amplitude. So electrons move with greater speed between two successive collisions. So **average relaxation time decreases with rising temperature.**
- When a potential difference is set across the conductor then an electric field is produced in the conductor. So the free electrons are accelerated in the opposite direction of the field during the relaxation time. So electrons move along the **parabolic path between two successive collisions.** So there is an effective displacement in the opposite direction of the applied electric field. This is called **drift.**
- Due to drift we get the flow of electrons in a particular direction. Hence we get a current opposite to the direction of motion of free electrons and in the direction of the electric field.

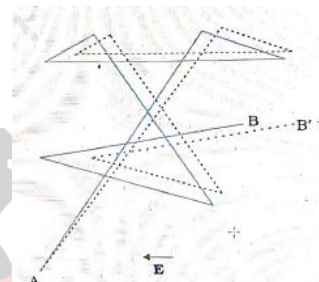

DRIFT VELOCITY:

The velocity with which free electrons in a conductor are drifted from lower potential to higher potential (i.e. towards +ve terminal) under the action of the applied electric field is called drift velocity.

The expression for drift velocity:

In the metallic conductors, just after collision with lattice ions, the electrons move in a random direction. So the average of velocities of all electrons just after a collision with lattice ions is zero.

Let $\vec{u}_1, \vec{u}_2, \vec{u}_3, \dots, \vec{u}_n$ be the velocities of various free electrons just after a collision,

$$\text{Then their average velocity, } \vec{u}_{\text{avg}} = \frac{\vec{u}_1 + \vec{u}_2 + \dots + \vec{u}_n}{n} = \vec{0} \quad \dots \dots \dots (i)$$

Let \vec{E} = uniform electric field set in the conductor of length L and uniform cross-section of area A .

$$V = \text{potential difference across the conductor. So } E = \frac{V}{L}$$

Due to the electric field, each free electron experiences a force in the opposite direction of the electric field during the relaxation time given by, $\vec{F} = -e\vec{E}$

So acceleration during relaxation time is

$$\vec{a} = \frac{\vec{F}}{m} = \frac{-e\vec{E}}{m} \dots \text{(ii)}$$

So velocities of the free electrons are $\vec{v}_1 = \vec{u}_1 + \vec{a}t_1$

$$\vec{v}_2 = \vec{u}_2 + \vec{a}t_2$$

.....

$$\vec{v}_n = \vec{u}_n + \vec{a}t_n$$

Where t_1, t_2, \dots, t_n = relaxation times of individual free electrons.

So average relaxation time is $\tau = \frac{t_1 + t_2 + \dots + t_n}{n} \dots \text{(iii)}$

Average velocity of the free electrons is drift velocity \vec{v}_d .

$$= \frac{\vec{v}_1 + \vec{v}_2 + \dots + \vec{v}_n}{n}$$

$$= \frac{(\vec{u}_1 + \vec{a}t_1) + (\vec{u}_2 + \vec{a}t_2) + \dots + (\vec{u}_n + \vec{a}t_n)}{n}$$

$$= \left(\frac{\vec{u}_1 + \vec{u}_2 + \dots + \vec{u}_n}{n} \right) + \vec{a} \left(\frac{t_1 + t_2 + \dots + t_n}{n} \right)$$

$$= \vec{0} + \vec{a}\tau = \vec{a}\tau = \frac{-e\vec{E}}{m} \tau \dots \text{(iv)} \quad \text{(Using equations (i),(ii) and (iii))}$$

Equation (iv) gives expression for drift velocity .

Its magnitude is $v_d = \frac{eE}{m} \tau = \frac{eV}{mL} \tau$ (As $v_d = \frac{eE}{m} \tau = \frac{eV}{mL} \tau$)

This is expression for drift speed.

This shows that, $v_d \propto V$, $v_d \propto \tau$, $v_d \propto \frac{1}{L}$

Note:

- The value of v_d is very small in the order of 1mm/s.
- The relaxation time for the free electron in a metal depends upon its nature and its physical conditions like temperature.
- With the rise in temperature, as average relaxation time decreases hence drift speed of free electrons also decreases.
- The drift velocity of the electrons should not be confused with the velocity with which electricity is conducted. Drift velocity of electrons is of the order of a few mm per second while the conduction of electricity, which is in the form of a wave-motion, takes with the velocity of light.

Question 6:

- (a) The electron drift speed is estimated to be only a few mm/s for currents in the range of few amperes. How then the current established almost the instant a circuit is closed?
- (b) The electron drift arises due to the force experienced by electrons in the electric field inside the conductor. But force should cause acceleration. Why then do the electrons acquire a steady average drift speed?
- (c) If electron drift speed is so small and the electron's charge is small, how can we still obtain a large amount of current in a conductor?
- (d) When electrons drift in metal from lower to higher potential, does it mean that all the free electrons of the metal are moving in the same direction?
- (e) Are the paths of electrons straight lines between successive collisions (with positive ions of the metal) in the
- (i) Absence of electric field, (ii) Presence of electric field.

(NCERT)

Solution:

- (a) The electric field is established throughout the circuit, almost instantly (with the speed of light) causing at every point a *local electron drift*. The establishment of the current does not have to wait for electrons from one end of the conductor traveling to the other end. However, it does take a little while for the current to reach its steady value.
- (b) Each 'free' electron does accelerate, increasing its drift speed until it collides with a positive ion of the metal. It loses its drift speed after the collision but starts to accelerate and increases its drift speed again only to suffer a collision again and so on. On average, therefore, electrons acquire only a drift speed.
- (c) Simple, because the electron number density is enormous, $\sim 10^{29} \text{ m}^{-3}$.
- (d) By no means. The drift velocity is superposed over the large random velocities of electrons.
- (e) In the absence of an electric field, the paths are straight lines; in the presence of the electric field, the paths are in general, curved.

The relation between electric current and drift velocity :

Consider a conductor of the uniform cross-section of area A . A uniform field is set inside it by applying a constant potential difference across the conductor. Due to this field, the free electrons present in the conductor will be drifted with a drift velocity v_d in the opposite direction of the field.

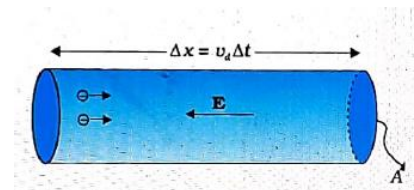

So time taken by a free electron to travel a distance after crossing a cross-section is $\Delta t = \frac{\Delta x}{v_d}$

If the number of free electrons per unit volume (i.e. number density) = n then the total number of free electrons crossing a cross-section in time t in the conductor = $nA\Delta x$ If 'e' is the charge on each electron, then total charge crossing a cross-section in time Δt is $\Delta q = nA\Delta x e$

Hence current through the conductor is $I = \frac{\Delta q}{\Delta t} = \frac{nA\Delta x e}{\Delta x / v_d} = nAv_d e \Rightarrow I = nAv_d e$

Notes : (i) Since A, n, and e are constants $I \propto v_d$

Hence, the electric current flowing through a conductor is directly proportional to the drift velocity.

(ii) If $I = \text{constant} \Rightarrow v_d \propto \frac{1}{A}$ (since $v_d = \frac{I}{nAe}$)

i.e. for constant current flowing through a conductor, drift speed is more in narrower cross-section and less in wider cross-section.

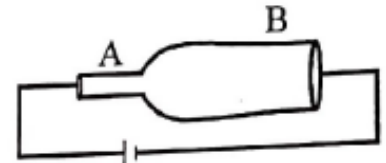

In the given figure $(v_d)_A > (v_d)_B$

(iii) As drift speed can be, $v_d = \frac{I}{nAe} = \frac{V}{RnAe} = \frac{V}{(\rho l/A)nAe} = \frac{V}{n\rho le}$

Hence if $V = \text{constant}$ then v_d is independent of the area of cross-section.

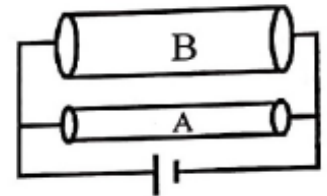

In the given figure $(v_d)_A = (v_d)_B$

Expression for conductivity in term of average relaxation time :

We know that current in term of drift speed is ; $I = nAv_d e$ (i)

Drift speed depends upon potential difference by the relation ; $v_d = \frac{eE}{m} \tau$ (ii)

Using equation (ii) in (i) we get $I = nAe \left(\frac{eE\tau}{m} \right) = \frac{ne^2\tau A}{m} E$

$\Rightarrow \frac{I}{A} = \frac{ne^2\tau}{m} E \Rightarrow J = \frac{ne^2\tau}{m} E$ (As $J = \text{current density} = I / A$)

$\Rightarrow \frac{J}{E} = \frac{ne^2\tau}{m} \Rightarrow \sigma = \frac{ne^2\tau}{m}$ (where $\sigma = \text{conductivity} = J/E$)

$\therefore \rho = \frac{1}{\sigma} = \frac{m}{ne^2\tau} = \text{resistivity}$

Mobility :

- Mobility of electrons is defined as the drift velocity acquired by the electrons due to a unit strength of the electric field.

If v_d is the drift velocity of free electrons due to a field strength E , Mobility of the electrons is

defined as $\mu = \frac{v_d}{E}$

- Mobility in term of relaxation time :

$$\text{As } \mu = \frac{v_d}{E} \Rightarrow \mu = \frac{\frac{eE\tau}{m}}{E} = \frac{e\tau}{m} \quad \left(\text{As } v_d = \frac{eE\tau}{m} \right)$$

- Relation between conductivity and mobility :

As current through a conductor is $I = nAv_d e$

$$\Rightarrow I = nAe\mu E \quad \left(\text{As } \mu = \frac{v_d}{E} \right)$$

$$\Rightarrow J = ne\mu E \quad \left(\text{As } J = I/A = \text{current density} \right)$$

$$\Rightarrow \sigma = ne\mu \quad \left(\text{As } \sigma = J/E \right)$$

- S.I. Unit of Mobility: $\text{ms}^{-1} \text{N}^{-1}\text{C}$. Dimensional formula is $[M^{-1}L^0T^2A^1]$

Question 7: For two nichrome wires connected in series with a battery, how does the ratio of drift velocities of electrons in them depend on their (i) lengths (ii) diameters.

Solutions: In series connection current is constant.

$$\therefore v_d = \frac{I}{nAe} \Rightarrow v_d \propto \frac{1}{A} \quad \Rightarrow \frac{(v_d)_1}{(v_d)_2} = \frac{A_2}{A_1} = \frac{\pi d_2^2}{\pi d_1^2} = \frac{d_2^2}{d_1^2}$$

In this case, drift speed is independent of length.

Question 8: In the given figures between the points A and B

(i) where drift velocity is high

(ii) where current is high

(iii) where the current density is high.

Explain the cause.

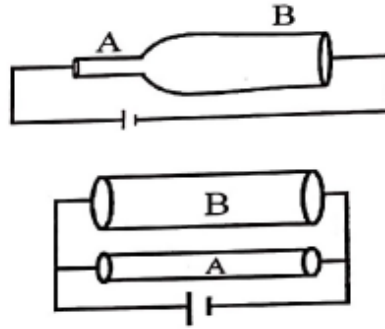

Solution :

For first figure; I = constant

$$(i) v_d = \frac{I}{nAe} \Rightarrow v_d \propto \frac{1}{A} \Rightarrow (v_d)_A > (v_d)_B \quad (ii) I_A = I_B \quad (iii) J = \frac{I}{A} \Rightarrow J \propto \frac{1}{A} \Rightarrow J_A > J_B$$

For second figure; V= constant

$$(i) v_d = \frac{I}{nAe} = \frac{V}{RnAe} = \frac{V}{\left(\frac{\rho l}{A}\right)nAe} = \frac{V}{nple}$$

$$\Rightarrow v_d \text{ is independent of area } \Rightarrow (v_d)_A = (v_d)_B$$

$$(ii) I = \frac{V}{R} = \frac{VA}{\rho l} \Rightarrow I \propto A \Rightarrow I_A < I_B$$

$$(iii) J = \frac{I}{A} = \frac{V}{RA} = \frac{VA}{\rho l A} = \frac{V}{\rho l} \Rightarrow J \text{ is independent of } A \Rightarrow J_A = J_B$$

Question 9 : The number density of free electrons in copper is estimated to be $8.5 \times 10^{28} \text{ m}^{-3}$. How long does an electron take to drift from one end of a wire 3.0 m long to its other end ? The area of cross-section of the wire is $2.0 \times 10^{-6} \text{ m}^2$ and it is carrying a current of 3.0 A. (NCERT)

Solution :

$$v_d = \frac{I}{nAe} = \frac{3}{8.5 \times 10^{28} \times 2 \times 10^{-6} \times 1.6 \times 10^{-19}} \text{ m/s} = 0.11 \times 10^{-3} \text{ ms}^{-1}$$

$$\Rightarrow t = \frac{d}{v_d} = \frac{3}{0.11 \times 10^{-3}} \text{ s} = 27.27 \times 10^3 \text{ s} = 7.575 \text{ h}$$

Question 10 : (a) A current of 1.0 A exists in a copper wire of cross-section 1.0 mm^2 . Assuming one free electron per atom calculates the drift speed of the free electrons in the wire. The density of copper is 9000 kg/m^3 and its atomic mass is 63.5 u. (b) Compare this drift speed with (i) thermal speed of copper atoms at ordinary temperature, (ii) speed of propagation of electric field along the conductor.

Solution :

$$(a) \text{ Number of atoms (N)} = \frac{\text{given mass(m)}}{\text{molar mass}(M_0)} \times \text{Avogadro's number}(N_A)$$

$$\therefore n = \frac{\text{number of free electrons}}{\text{volume}} = \frac{\text{number of atoms(N)}}{\text{volume(V)}}$$

$$= \frac{\left(\frac{m N_A}{M_0} \right)}{V} = \frac{m}{V} \times \frac{N_A}{M_0} = (\text{density}) \times \frac{N_A}{M_0} = 9000 \times \frac{6.023 \times 10^{23}}{63.5 \times 10^{-3}} \text{ m}^{-3} = 8.85 \times 10^{28} \text{ m}^{-3}$$

$$\therefore v_d = \frac{I}{nAe} = \frac{1.0}{8.5 \times 10^{28} \times 10^{-6} \times 1.6 \times 10^{-19}} \text{ ms}^{-1} = 7.4 \times 10^{-5} \text{ ms}^{-1}$$

(b) (i) At a temperature T , the thermal speed* of a copper atom of mass M is obtained from $[\langle (1/2) Mv^2 \rangle = (3/2) k_B T]$ and is thus typical of the order of $\sqrt{k_B T / M}$, where k_B is the Boltzmann constant. For copper at 300 K, this is about $2 \times 10^2 \text{ m/s}$. This figure indicates the random vibrational speeds of copper atoms in a conductor. Note that the drift speed of electrons is much smaller, about 10^{-5} times the typical thermal speed at ordinary temperatures.

(ii) An electric field traveling along the conductor has a speed of an electromagnetic wave, namely equal to $3.0 \times 10^8 \text{ m s}^{-1}$. The drift speed is, in comparison, extremely small; smaller by a factor of 10^{-11} .

Ohm's Law :

Statement: According to this law at constant temperature and mechanical stress the current flowing through a conductor of a uniform area of the cross-section is directly proportional to the applied potential difference.

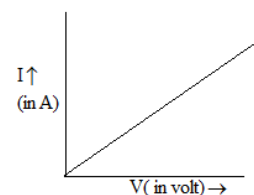

Mathematically, we can write

I Ohm's Law :

Statement: According to this law at constant temperature and mechanical stress the current flowing through a conductor of a uniform area of cross-section is directly proportional to the applied potential difference.

Mathematically, we can write

$$I \propto V$$

$$\Rightarrow I = GV = \frac{V}{R}$$

$$\Rightarrow \frac{V}{I} = R = \text{constant.}$$

So the graph between current and voltage is a straight line

$$\text{The slope of the graph} = \frac{\Delta V}{\Delta I} = G = \frac{1}{R}$$

Where G = conductance of the conductor

R = resistance of the conductor

Question 11: A copper wire of radius 0.1 mm and resistance $1 \text{ k}\Omega$ is connected across a power supply of 20 V. How many electrons are transferred per second between the supply and the wire at one end?

$$\text{Solution : } I = \frac{V}{R} = \frac{20\text{V}}{1000\Omega} = 2 \times 10^{-2} \text{ A}$$

$$\therefore \text{number of free electrons flowing per second} = \frac{q}{e \times t} = \frac{I}{e} = \frac{2 \times 10^{-2} \text{ A}}{1.6 \times 10^{-19} \text{ C}} = 1.25 \times 10^{17} \text{ s}^{-1}$$

Factors affecting resistance :

The resistance of a conductor depends upon ;

(i) length of wire: $R \propto l$ (i)

(ii) area of cross-section : $R \propto \frac{1}{A}$... (ii)

(iii) material of conductor

(iv) temperature

Combining (i) and (ii) we get

$$R \propto \frac{l}{A} \Rightarrow R = \rho \frac{l}{A}$$

Where ρ = resistivity of the material of conductor which depends upon the material of conductor and temperature.

S.I. unit of resistance is **Ohm (Ω)**.

1 Ω = 1 V/A (volt / ampere)

Thus the resistance of a conductor is said to be one ohm if a current of 1 amp flows through it when the potential difference across its ends is 1 volt.

$$\text{Dimensional formula : } [R] = \left[\frac{V}{I} \right] = \left[\frac{M^1 L^2 T^{-3} A^{-1}}{A} \right] = [M^1 L^2 T^{-3} A^{-2}]$$

S.I. unit of conductance is Ω^{-1} , **mho or siemen**

1 **siemen** = 1 A / V (ampere/ volt)

Thus the conductance of a conductor is said to be one siemens if a current of 1 amp flows through it when the potential difference across its ends is 1 volt.

$$\text{Dimensional formula : } [G] = \left[\frac{I}{V} \right] = \left[\frac{A}{M^1 L^2 T^{-3} A^{-1}} \right] = [M^{-1} L^{-2} T^3 A^2]$$

The relation between electric field intensity (E) and current density (J) OR Ohm’s law in vector form OR Microscopic form of Ohm’s law:

Let us consider a conductor of length L and uniform cross-section of area A.

Let V be the potential difference at the two ends.

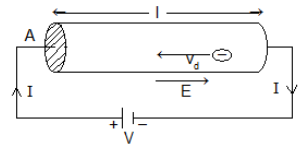

So an electric field of strength \vec{E} is set up in the conductor. The direction \vec{E} will be parallel to the length of the conductor from high potential end to low potential end.

As field is uniform $V = E L \Rightarrow E = \frac{V}{L}$

Due to the potential difference a constant current, is produced from high potential end to low potential end i.e. along the direction of the field.

According to Ohm’s law;

$$V = R I$$

$$\Rightarrow V = \frac{\rho L}{A} I \quad (\text{As } R = \frac{\rho L}{A})$$

$$\Rightarrow \frac{V}{L} = \frac{\rho I}{A}$$

$$\Rightarrow E = \rho J \quad (\text{As } \frac{V}{L} = E \text{ and } \frac{I}{A} = J)$$

$$\Rightarrow J = \frac{E}{\rho} = \sigma E \quad (\text{As } \sigma = \frac{1}{\rho}) \dots\dots(i)$$

Here R = resistance of the conductor

ρ = resistivity of the material of the conductor

σ =conductivity of the material of the conductor

J = current density at any point of a cross-section of the conductor.

As \vec{J} is directed along the direction of flow of current i.e. the direction of the field \vec{E} .

So equation (i) can be written vector ally as

$$\vec{J} = \sigma \vec{E} = \frac{\vec{E}}{\rho}$$

This is a vector form of Ohm's law.

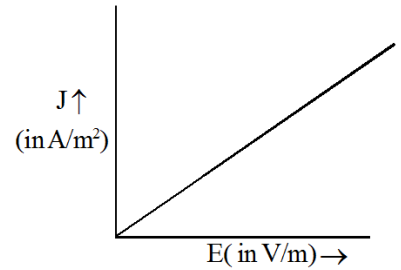

The graph between J and E must be a straight line passing

through the origin. Its slope = $\frac{\Delta J}{\Delta E} = \sigma$

Question 12: Using the drift speed concept establish Ohm's law.

OR

Using the drift speed concept establish the relation $\vec{J} = \sigma \vec{E}$

Solution: As current through the conductor is

$$I = \frac{q}{t} = \frac{nAle}{l/v_d} = nAv_d e \dots\dots\dots(i)$$

Where n = number density of free electrons in the conductor of length 'l' and area of cross-section A.

v_d = drift speed or average steady speed of free electrons in the conductor

We know that drift speed is given by; $v_d = \frac{eE}{m} \tau = \frac{eV}{ml} \tau \dots\dots\dots(ii)$

Using equation (ii) in (i) we get

$$I = nAe \left(\frac{eV\tau}{ml} \right) = \frac{ne^2\tau A}{ml} V$$

$\Rightarrow I \propto V$. Hence Ohm's law is established.

$$\Rightarrow \frac{I}{A} = \frac{ne^2\tau}{m} \frac{V}{l} = \frac{ne^2\tau}{m} E$$

$$\Rightarrow J = \frac{ne^2\tau}{m} E$$

$$\Rightarrow J = \sigma E \quad \left(\because \sigma = \frac{ne^2\tau}{m} \right)$$

Question 13: Calculate the electric field in a copper wire of uniform cross-section of area 10^{-5} m^2 , if it carries a current of 10 A. Resistivity of copper is $1.72 \times 10^{-8} \Omega\text{m}$.

Solution : $J = \frac{E}{\rho} \Rightarrow E = J\rho = \frac{I\rho}{A} = \frac{10 \times 1.72 \times 10^{-8}}{10^{-5}} \text{ Vm}^{-1} = 1.72 \times 10^{-2} \text{ Vm}^{-1}$

Drawbacks of Ohm’s law :

(i) All conductors don’t obey strictly. The conductors which obey Ohm’s law strictly are called as Ohmic conductors and those don’t obey Ohm’s law are called as non-ohmic conductors

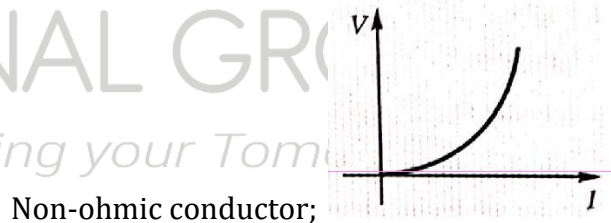
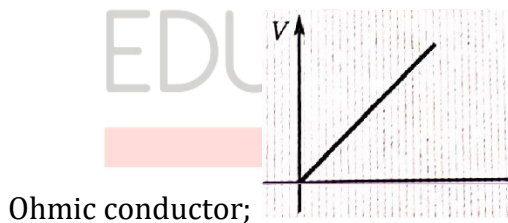

(ii) At higher temperature graph between the current and voltage of a good conductor also deviates from a straight line.

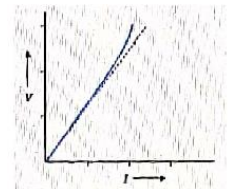

(iii) The semiconductor devices like pn junction diode, junction transistors, vacuum tube devices don’t obey Ohm’s law.e.g. the $I \sim V$ curve of a PN junction is

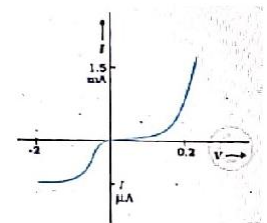

(iv) The $I \sim V$ curve of GaAs represents that (a) for a single value of current there exist two values of voltage (b) non-linear region and (c) negative resistance region. Hence this doesn't obey Ohm's law.

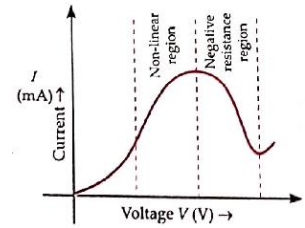

Electric power and electrical energy :

The expression for heat dissipated from a conductor during the flow of current :

Consider a conductor AB of a uniform cross-section of area A and length be connected across a source that sends steady current I.

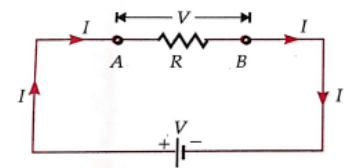

So $V_A - V_B = IR = V =$ Potential difference across the conductor.

Due to this, charge carriers i.e. free electrons drift from B to A.

Imagine an equivalent +ve charge flows from A to B.

In a very small time, 'dt' the equivalent +ve charge flowing from A to B is $dq = Idt$,

The potential energy of this charge at A is $U_A = V_A dq$ and at B is $U_B = V_B dq$

So change in its P.E. is $dU = U_B - U_A = dq(V_B - V_A) = -IRdq$

As the potential energy of charge decreases as moving from A to B, then its K.E. must increase.

As drift speed is constant so there is no increase in K. E. of the charge carriers between A and B.

Hence the increase in K.E. of any charge carrier is given to the lattice ion during a collision. So lattice ions vibrate with more energy and the temperature of the conductor increases. Hence heat energy is dissipated which is equal to the decrease in P.E.

i.e. $dH = -dU = IRdq = IR(Idt) = I^2Rdt$

Total heat dissipated in time t is $H = \int_0^t I^2Rdt$

For steady current $I = \text{constant}$. So $H = I^2Rt$

The expression for electrical energy and electrical power :

Again when the charge reaches A after a cycle its P.E. becomes $V_A dq$ i.e. P.E. increases from $V_B dq$ to $V_A dq$ during the return.

To increase P.E. some work must be done and this work is done by the external voltage source.

The work done by the voltage source to increase the P.E. of the charge carrier from B to A is called as **Electrical energy (W)**.

∴ For small-time dt the electrical energy consumed is $dW = (V_A - V_B)dq = VI dt$

The total electrical energy consumed in any time t is $W = \int_0^t VI dt$

For steady current I and V are constants then the electrical energy consumed in time t is;

$$W = VI t$$

The rate at which electrical energy is consumed is called an **electrical power**.

The power at any instant is $P = \frac{dW}{dt} = \frac{VI dt}{dt} = VI$

The average power consumed in a time t is $P_{av} = \frac{W}{t} = \frac{\int_0^t VI dt}{\int_0^t dt}$

SI unit of power is the watt(W). $1W = 1VA$

Some practical units of power are

(i) $1 kW = 1000 W$ (ii) $1 MW = 10^6 W$ (iii) $1 GW = 10^9 W$ (iv) $1 hp = 746 W$

SI unit of electrical energy is joule (J) . $1J = 1CV$

A practical unit of electrical energy is 1 B.O.T. unit = $1 kWh = (1000 W)(3600 s) = 3.6 \times 10^6 J$

Rated power of a device: Rated power of a device is the power consumed by it when connected across the rated voltage i.e. the household voltage (220 V).

If the rated voltage of a device is V_0 and rated power is P_0 then, its resistance is; $R = \frac{V_0^2}{P_0}$ and

maximum current that can pass through it is ; $I_0 = \frac{P_0}{V_0}$

If the device is used across voltage V_0 then only it consumes power P_0 .

If the device is used across voltage V then power consumed is $P = \frac{V^2}{R} = \frac{V^2}{\frac{V_0^2}{P_0}} = \frac{V^2}{V_0^2} P_0$

Zero watts bulb: Rated power of zero watt bulb is 0 . its resistance $R = \frac{V_0^2}{P_0} = \frac{V_0^2}{0} = \infty$.

Practically it consumes a very small power, so its resistance is very high.

Question 14: In the circuit shown in the figure find out

(i) power supplied by 10 V battery

(ii) Power consumed by 4V battery

(iii) the power dissipated by 3 Ω resistor

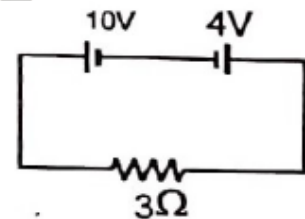

Solution: In the circuit, current $I = \frac{10-4}{3} \text{ A} = 2\text{A}$

(i) Power supplied by 10 V battery, $P_s = 10\text{V} \times 2\text{A} = 20\text{W}$

(ii) Power consumed by 4 V battery, $P_c = 4\text{V} \times 2\text{A} = 8\text{W}$

(iii) The power dissipated by 3 Ω resistors, $P_D = (2\text{A})^2 \times 3\Omega = 12\text{W}$

Question 15: An electric current of 2.0 A passes through a wire of resistance 25 Ω . How much heat will be developed in 1 minute?

Solution : $H = I^2 R t = (2\text{A})^2 \times 25\Omega \times 60\text{s} = 6000\text{W} = 6\text{kW}$

Question 16 : An electric bulb is rated as 100W - 220 V . Calculate

(i) its resistance

(ii) power consumed by it when connected across 220 V .

(iii) power consumed by it when connected across 120 V.

Solution : (i) $R = \frac{V^2}{P} = \frac{220 \times 220}{100} \Omega = 484 \Omega$

(ii) Across 220 V source ; $P = 100W$

(iii) Across 120 V source ; $P = \frac{V^2}{R} = \frac{120 \times 120}{484} W = 29.75W$

Question 17 : State Joule's law of heating .

Solution: Heat dissipated from a current-carrying conductor is directly proportional to the square of the current, resistance of the conductor, and time of flow of current.

i.e. $H \propto I^2$, $H \propto R$ and $H \propto t$

$$\Rightarrow H \propto I^2 R t$$

Question 18: A 25 W and a 100W bulb are joined in (i) series (ii) parallel and connected to the main. Which bulb glows brighter?

Solution :

(i) In series; $I = \text{constant}$

$$\Rightarrow P = I^2 R \Rightarrow P \propto R$$

$$\text{Since } R_{25W} > R_{100W} \Rightarrow P_{25W} > P_{100W}$$

So 25 W bulb glows brighter .

(ii) In parallel, $V = \text{constant}$

$$\Rightarrow P = \frac{V^2}{R} \Rightarrow P \propto \frac{1}{R}$$

$$\text{Since } R_{25W} > R_{100W} \Rightarrow P_{25W} < P_{100W}$$

So 100 W bulb glows brighter.

Resistivity: As the resistance of a conductor is $R = \rho \frac{l}{A}$

Hence resistivity is ; $\rho = \frac{RA}{l}$

So resistivity of a conductor is defined as the resistance of a conductor made up of the same material having a unit length and unit area of cross-section.

S.I. unit of resistivity: In S.I. system the unit of resistivity is ohm meter ($\Omega \text{ m}$)

Dimensional formula : $[\rho] = \left[\frac{RA}{l} \right] = \left[\frac{(M^1 L^2 T^{-3} A^{-2})(L^2)}{L} \right] = [M^1 L^3 T^{-3} A^{-2}]$

Conductivity (σ): Conductivity is the reciprocal of resistivity. So the conductivity of a conductor is $\sigma = \frac{1}{\rho} = \frac{l}{RA} = \frac{Gl}{A}$. So conductivity of a conductor is defined as the conductance of a conductor made up of the same material having a unit length and unit area of cross-section.

S.I. units of conductivity :

In S.I. system the unit of resistivity is **siemens/meter**

Dimensional formula : $[\sigma] = \left[\frac{Gl}{A} \right] = \left[\frac{(M^{-1} L^{-2} T^3 A^2)(L)}{L^2} \right] = [M^{-1} L^{-3} T^3 A^2]$

Question 19: How will the resistance and resistivity of a cylindrical wire change if

(i) its length is doubled (ii) It is doubled on itself (iii) It is stretched to double its length?

Solution :

(i) As $R \propto l$ then resistance is doubled by doubling its length.

(ii) As the wire is doubled on itself, length becomes $\frac{1}{2}$ and area of cross-section becomes $2A$.

$$\text{Since } R \propto \frac{l}{A} \quad \Rightarrow \quad \frac{R'}{R} = \frac{1/2}{1} \times \frac{A}{2A} = \frac{1}{4} \quad \Rightarrow \quad R' = \frac{R}{4}$$

(iii) As the wire is stretched to double its length then its length becomes $2l$ and area of cross-section becomes $A/2$.

$$\text{Since } R \propto \frac{l}{A} \quad \Rightarrow \quad \frac{R'}{R} = \frac{2l}{1} \times \frac{A/2}{A} = 2 \quad \Rightarrow \quad R' = 2R$$

In all the above cases resistivity will not change as it depends on the nature of the material, not upon its shape and size.

Question 20: How will the resistance and resistivity of a cylindrical wire change if

(i) it is stretched to n times its length (ii) It is stretched to have radius $1/n$ times the original value? Show the graphical variation between the resistance of the wire and its radius.

Solution :

(i) As wire is stretched, length becomes nl and area of cross-section becomes A/n

$$\text{Since } R \propto \frac{l}{A} \quad \Rightarrow \quad \frac{R'}{R} = \frac{nl}{1} \times \frac{A/n}{A} = n^2 \quad \Rightarrow \quad R' = n^2 R$$

(ii) As wire is stretched, radius becomes r/n \Rightarrow area of cross-section becomes

\Rightarrow length becomes $n^2 l$

$$\text{Since } R \propto \frac{l}{A} \quad \Rightarrow \quad \frac{R'}{R} = \frac{n^2 l}{1} \times \frac{A/n^2}{A} = n^4 \quad \Rightarrow \quad R' = n^4 R$$

In all the above cases resistivity will not change as it depends on the nature of material, not upon its shape and size.

$$\text{As } R \propto \frac{l}{A} \quad \Rightarrow \quad R \propto \frac{l}{\pi r^2} \quad \Rightarrow \quad R \propto \frac{1}{r^2}$$

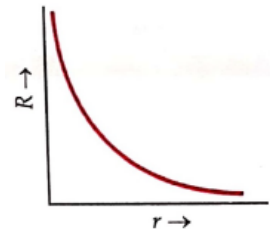

Question 21: A negligibly small current is passed through a wire of length $15\ \Omega\ \text{m}$ and uniform cross-section $6.0 \times 10^{-7}\ \text{m}^2$ and its resistance is measured to be 5.0 . What is the resistivity of the material at the temperature of the experiment? (NCERT)

$$\text{Solution : } \rho = \frac{RA}{l} = \frac{5 \times 6 \times 10^{-7}}{15} \Omega\text{m} = 2 \times 10^{-7} \Omega\text{m}$$

Question 22: Two wires of equal length, one of Al and the other of Cu have the same resistance. Which of the two is lighter? Hence, explain why Al wires are preferred for overhead power cables?

$$(\rho_{\text{Al}} = 2.63 \times 10^{-8} \Omega\text{m}, \rho_{\text{Cu}} = 1.72 \times 10^{-8} \Omega\text{m},)$$

Relative densities of Al = 2.7 and of Cu = 8.9 (NCERT)

Solution :

$$R_{\text{Al}} = R_{\text{Cu}} \Rightarrow \frac{\rho_{\text{Al}} l}{A_{\text{Al}}} = \frac{\rho_{\text{Cu}} l}{A_{\text{Cu}}}$$

$$\Rightarrow \frac{A_{\text{Al}}}{A_{\text{Cu}}} = \frac{\rho_{\text{Cu}}}{\rho_{\text{Al}}} = \frac{1.72 \times 10^{-8}}{2.63 \times 10^{-8}} = 1.53$$

$$\therefore \frac{m_{\text{Al}}}{m_{\text{Cu}}} = \frac{2.7 \times A_{\text{Al}} \times l}{8.9 \times A_{\text{Cu}} \times l} = \frac{2.7}{8.9} \times 1.53 = 0.464$$

$\therefore m_{\text{Al}} < m_{\text{Cu}}$ i.e. Al is lighter than copper.

So Al is preferred for overhead power cables

Question 23: Two wires of equal length, one of Al and other of managing have the same resistance. Which of the two is thicker? Give reason.

$$\text{Solution : } R_{\text{Al}} = R_{\text{manganin}} \Rightarrow \frac{\rho_{\text{Al}} l}{A_{\text{Al}}} = \frac{\rho_{\text{manganin}} l}{A_{\text{manganin}}} \Rightarrow \frac{A_{\text{Al}}}{A_{\text{manganin}}} = \frac{\rho_{\text{Al}}}{\rho_{\text{manganin}}}$$

Since manganin is an alloy hence $\rho_{\text{manganin}} > \rho_{\text{Al}}$

$\Rightarrow A_{\text{manganin}} > A_{\text{Al}}$ i.e. manganin is thicker.

Resistor :

- Resistors are the circuit elements which are used in electrical circuits to reduce potentials.



- Circuit symbol of the resistor is
- If a resistor has resistance R and a current I passes through it then voltage drop or potential drop across it is $V = IR = V_A - V_B$. A and B are two ends of a resistor with current flowing from A to B .
- Commercially produced resistors for domestic use or in laboratories are of two major types:
(i) wire bound resistors and (ii) carbon resistors.
- Wire bound resistors are made by winding the wires of an alloy, viz., manganin, constantan, nichrome, or similar ones. The choice of these materials is dictated mostly by the fact that their resistivities are relatively insensitive to temperature.

These resistances are typically in the range of a fraction of an ohm to a few hundred ohms.

- Resistors in the higher range are made mostly from carbon.

Carbon resistors are compact, inexpensive and thus find extensive use in electronic circuits.

Carbon resistors are small in size and hence their values are given using a color code.

- Colour coding of carbon resistors :**

The resistors have a set of four co-axial colored rings on them with every color having particular significance as listed in the table given below.

Colour	Number	Multiplier	Tolerance (%)
Black	0	1	
Brown	1	10^1	
Red	2	10^2	
Orange	3	10^3	
Yellow	4	10^4	
Green	5	10^5	
Blue	6	10^6	
Violet	7	10^7	
Gray	8	10^8	
White	9	10^9	
Gold		10^{-1}	5
Silver		10^{-2}	10
No colour			20

Significances of the bands :

- (i) The first two *bands* from the end indicate the first two significant figures of the resistance in ohms.
- (ii) The third band indicates the decimal multiplier (as listed in Table).
- (iii) The last band stands for tolerance or possible variation in percentage about the indicated values. Sometimes, this last band is absent and that indicates a tolerance of 20%.

i.e. $R = [][] \times 10^l \Omega \pm []\%$

Note: For remembering the color coding remember;

BBROY Great Britain Very Good Wife Gold Silver Necklace.

Every capital letter represents the name of the color.

Question 24: Give color coding for $42\text{k}\Omega \pm 10\%$ carbon resistance.

Solution :

$$42\text{k}\Omega \pm 10\% = 42 \times 10^3 \Omega \pm 10\%$$

So color coding is; yellow, red, orange, silver

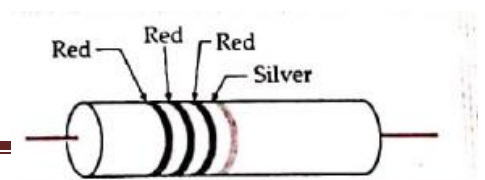

Question 25: The figure shows the color-coding of a carbon resistor. Find its resistance.

Solution :

The first two red stripes represent the first two significant figures each 2.

The third red stripe represents the multiplier 10^2 .

The fourth strip i.e. silver represents 10% tolerance.

So the resistance is $22 \times 10^2 \Omega \pm 10\%$;

Series Combination of resistances :

In series combination, resistances are connected end to end in one path.

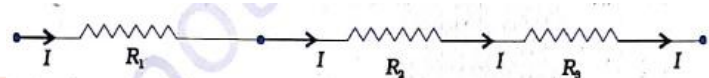

Current through all resistances are the same

The total potential difference across the combination is equal to the sum of potential difference across individual resistances i.e. $V = V_1 + V_2 + \dots$

In the given figure, the resistances R_1 , R_2 , and R_3 are in series across a potential difference V .

Let I = current through the combination.

So equivalent resistance of the combination is $R_{eq} = \frac{V}{I}$ (i)

As a series combination, the current through each resistance is I .

So voltage across individual resistances are

$$V_1 = IR_1 \quad \dots\dots\dots(ii-A)$$

$$V_2 = IR_2 \quad \dots\dots\dots(ii-B) ,$$

$$V_3 = IR_3 \quad \dots\dots\dots(ii-C) ,$$

As in series combination , $V = V_1 + V_2 + V_3$

$$\Rightarrow IR_{eq} = I_1R_1 + I_2R_2 + I_3R_3$$

Using equations (i) and (ii)

$$\Rightarrow R_{eq} = R_1 + R_2 + R_3$$

For large number of resistances in series, $R_{eq} = R_1 + R_2 + R_3 + \dots$

So in series combination equivalent resistance is equal to the sum of individual resistances. This is the law of a series combination of resistances.

For n-identical resistances in series

$$R_{eq} = nR$$

Ratio among voltages of resistances is

$$V_1 : V_2 : V_3 : \dots = R_1 : R_2 : R_3 : \dots$$

The ratio among powers consumed by resistances is $P_1 : P_2 : P_3 : \dots = R_1 : R_2 : R_3 : \dots$

Question 26: (a) Three resistors 1Ω , 2Ω and 3Ω are combined in series. What is the total resistance of the combination?

(b) If the combination is connected to a battery of emf 12 V and negligible internal resistance, then obtain the potential drop across each resistor.

(NCERT)

Solution :

$$(a) R_{eq} = 1\Omega + 2\Omega + 3\Omega = 6\Omega$$

$$(b) I = \frac{V}{R_{eq}} = \frac{12\text{V}}{6\Omega} = 2\text{A}$$

$$\therefore V_1 = IR_1 = 2\text{A} \times 1\Omega = 2\text{V}, \quad V_2 = IR_2 = 2\text{A} \times 2\Omega = 4\text{V}, \quad V_3 = IR_3 = 2\text{A} \times 3\Omega = 6\text{V}$$

Parallel Combination of resistances:

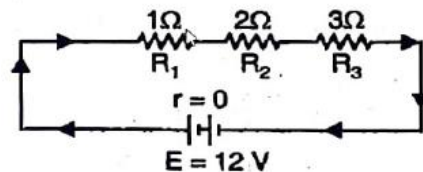

In parallel combination, one end of resistances is connected to one point and the other end of all resistances are connected to another point.

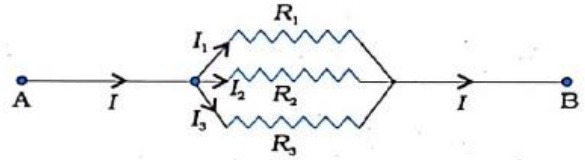

The potential difference across each resistance is the same and equal to the potential difference of the combination

Total current given to the combination is equal to the sum of currents through individual resistances

i.e. $I = I_1 + I_2 + \dots$

In the given figure, the resistances $R_1, R_2,$ and R_3 are in parallel across a potential difference V .

So potential difference across each resistance = V

Let I = current through the combination.

So equivalent resistance of the combination is

$$R_{eq} = \frac{V}{I} \Rightarrow I = \frac{V}{R_{eq}} \dots\dots\dots(i).$$

Now current through individual resistances are

$$I_1 = \frac{V}{R_1}, I_2 = \frac{V}{R_2} \text{ and } I_3 = \frac{V}{R_3} \dots\dots\dots(ii)$$

As in parallel combination , $I = I_1 + I_2 + I_3$

$$\Rightarrow \frac{V}{R_{eq}} = \frac{V}{R_1} + \frac{V}{R_2} + \frac{V}{R_3}$$

Using equations (i) and (ii)

$$\Rightarrow \frac{1}{R_{eq}} = \frac{1}{R_1} + \frac{1}{R_2} + \frac{1}{R_3}$$

For a large number of resistances in parallel, $\frac{1}{R_{eq}} = \frac{1}{R_1} + \frac{1}{R_2} + \frac{1}{R_3} + \dots$

So in parallel combination reciprocal of equivalent resistance is equal to the sum of reciprocals of individual resistances. This is the law of a parallel combination of resistances.

For two resistances in parallel

$$R_{\text{eq}} = \frac{R_1 R_2}{R_1 + R_2}$$

For three resistances in parallel

$$R_{\text{eq}} = \frac{R_1 R_2 R_3}{R_1 R_2 + R_1 R_3 + R_2 R_3}$$

For n identical resistances in parallel

$$R_{\text{eq}} = \frac{R}{n}$$

The ratio among currents through individual resistances is $I_1 : I_2 : I_3 : \dots = \frac{1}{R_1} : \frac{1}{R_2} : \frac{1}{R_3} : \dots$

The ratio among powers consumed by resistances is $P_1 : P_2 : P_3 : \dots = \frac{1}{R_1} : \frac{1}{R_2} : \frac{1}{R_3} : \dots$

Question 27 : (a) Three resistors 2Ω , 4Ω and 5Ω are combined in parallel. What is the total resistance of the combination?

(b) If the combination is connected to a battery of emf 20 V and negligible internal resistance, then obtain the current through each resistor and total current drawn from the battery.

(NCERT)

Solution :

$$(a) \frac{1}{R_{\text{eq}}} = \frac{1}{2} + \frac{1}{4} + \frac{1}{5} = \frac{10+5+4}{20} = \frac{19}{20} \Omega^{-1} \Rightarrow R_{\text{eq}} = \frac{20}{19} \Omega$$

$$(b) \text{Current through } 2\Omega \text{ is; } I_1 = \frac{V}{R_1} = \frac{20}{2} = 10\text{A}$$

$$\text{Current through } 4\Omega \text{ is; } I_2 = \frac{V}{R_2} = \frac{20}{4} = 5\text{A}$$

$$\text{Current through } 5\Omega \text{ is; } I_3 = \frac{V}{R_3} = \frac{20}{5} = 4\text{A}$$

$$\text{So the total current is } I = I_1 + I_2 + I_3 = 10\text{A} + 5\text{A} + 4\text{A} = 19\text{A}$$

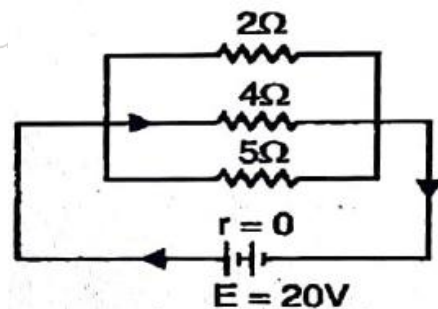

Question 28: Three resistors of resistances R_1 , R_2 and R_3 are connected between points A and C across a potential difference V . Obtain expressions for

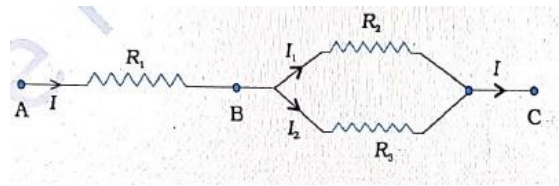

- (a) the total current is drawn from the source,
- (b) the potential drop across each resistor.
- (c) current through each resistor.

Solution :

(a) In the combination R_2 and R_3 are in parallel between points B and C. Its equivalent resistance R_p is in series with R_1 .

$$\text{So } R_{eq} = R_1 + \frac{R_2 R_3}{R_2 + R_3} = \frac{R_1 R_2 + R_1 R_3 + R_2 R_3}{R_2 + R_3} \Rightarrow I = \frac{V}{R_{eq}} = \frac{V(R_2 + R_3)}{R_1 R_2 + R_1 R_3 + R_2 R_3}$$

(b) $V_{AB} = IR_1 = \frac{V(R_2 + R_3)R_1}{R_1 R_2 + R_1 R_3 + R_2 R_3} = \frac{V(R_1 R_2 + R_1 R_3)}{R_1 R_2 + R_1 R_3 + R_2 R_3}$ = potential drop across R_1 .

$$V_{BC} = IR_p = \frac{V(R_2 + R_3)}{R_1 R_2 + R_1 R_3 + R_2 R_3} \cdot \frac{R_2 R_3}{(R_2 + R_3)} = \frac{V(R_2 R_3)}{R_1 R_2 + R_1 R_3 + R_2 R_3}$$

the potential drop across R_2 and R_3 each.

(c) $I_1 = \frac{V_{BC}}{R_2} = \frac{1}{R_2} \frac{V(R_2 R_3)}{R_1 R_2 + R_1 R_3 + R_2 R_3} = \frac{V(R_3)}{R_1 R_2 + R_1 R_3 + R_2 R_3}$

$$I_2 = \frac{V_{BC}}{R_3} = \frac{1}{R_3} \frac{V(R_2 R_3)}{R_1 R_2 + R_1 R_3 + R_2 R_3} = \frac{V(R_2)}{R_1 R_2 + R_1 R_3 + R_2 R_3}$$

Question 29 : (a) Given n resistors each of resistance R . How will you combine them to get (i) maximum (ii) minimum effective resistance?

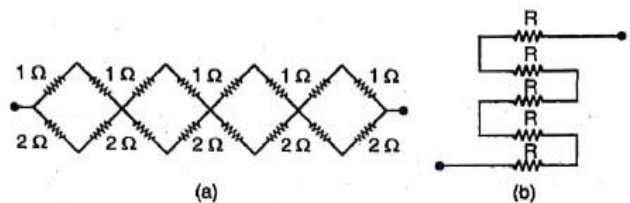

What is the ratio of the maximum to the minimum resistance?

(b) Given the resistances of 1Ω , 2Ω and 3Ω , how will combine them to get the equivalent resistance of (i) $(\frac{11}{3})\Omega$ (ii) $(\frac{11}{5})\Omega$ (iii) 6Ω (iv) $(\frac{6}{11})\Omega$

(c) Determine the equivalent resistance of networks shown in the figure, (NCERT)

Solution :

(a) (i) The maximum resistance is in series, $R_{\max} = nR$

(ii) Minimum resistance is in parallel, $R_{\min} = \frac{R}{n}$, $\frac{R_{\max}}{R_{\min}} = \frac{nR}{R/n} = n^2$

(b) (i) By combining a parallel combination of 1Ω and 2Ω in series with 3Ω

(ii) By combining a parallel combination of 3Ω , 2Ω and 1Ω in series with

(iii) By combining all in series

(iv) By combining all in parallel

(c) For network (a) $R_{\text{eq}} = 4 \times \frac{(1\Omega + 1\Omega)(2\Omega + 2\Omega)}{(1\Omega + 1\Omega) + (2\Omega + 2\Omega)} = 4 \times \frac{8}{6} \Omega = \frac{16}{3} \Omega$ For network (b)

$$R_{\text{eq}} = 5R$$

Question 30: Determine the current and power drawn from a 12 V supply with internal resistance 0.5Ω by infinite network shown in the figure. (NCERT)

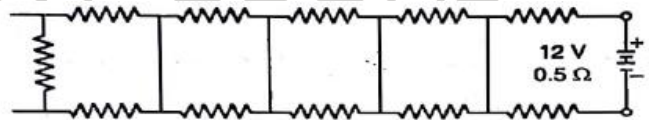

Solution :

Let the equivalent resistance of the network be $x \Omega$.

Its equivalent network becomes as shown in the figure.

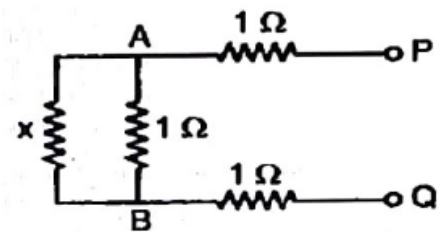

$$\text{So, } R_{\text{eq}} = 1 + \frac{1 \cdot x}{1 + x} + 1 \Rightarrow x = \frac{(1 + x) + x + (1 + x)}{1 + x}$$

$$\Rightarrow x + x^2 = 2 + 3x \Rightarrow x^2 - 2x - 2 = 0$$

$$\Rightarrow x = \frac{-(-2) \pm \sqrt{(-2)^2 - 4(1)(-2)}}{2 \times 1} = \frac{2 \pm 2\sqrt{3}}{2} = 1 \pm \sqrt{3}$$

As equivalent resistance can't be negative.

$$\therefore x = 1 + \sqrt{3} = 1 + 1.73 = 2.73$$

So equivalent resistance = 2.73Ω

So current drawn is ; $I = \frac{\xi}{r + R} = \frac{12V}{0.5\Omega + 2.73\Omega} = \frac{12V}{3.23\Omega} = 3.72A$

Power drawn is ; $P = VI = I^2R = (3.72A)^2 \times 2.73\Omega = 37.78W$

Question 31: Two devices of rated powers P_1 and P_2 with rated voltage v each are connected in

(i) series (ii) parallel across a supply of potential difference V . Obtain the equivalent power consumption in series and parallel combination.

Solution :

(i) Two devices of rated powers P_1 and P_2 with rated voltage v each are connected in series across a voltage v .

Their resistances $R_1 = \frac{V^2}{P_1}$ and $R_2 = \frac{V^2}{P_2}$ (i)

The equivalent resistance of the combination is $R = R_1 + R_2$

The total power consumed is $P = \frac{V^2}{R_1 + R_2}$

$$\Rightarrow \frac{1}{P} = \frac{R_1 + R_2}{V^2} = \frac{R_1}{V^2} + \frac{R_2}{V^2} = \frac{1}{P_1} + \frac{1}{P_2} \quad (\text{Using equation (i)})$$

So power consumed is less than the power consumed by the individual device.

(ii) Two devices of rated powers P_1 and P_2 with rated voltage V each are connected in parallel across a voltage V .

Their resistances $R_1 = \frac{V^2}{P_1}$ and $R_2 = \frac{V^2}{P_2}$ (i)

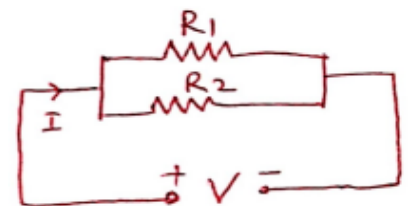
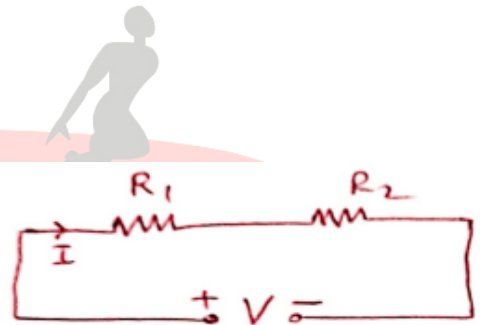

Their equivalent resistance is. In parallel combination $\frac{1}{R} = \frac{1}{R_1} + \frac{1}{R_2}$

So total power consumed is $P = \frac{V^2}{R} = V^2 \left(\frac{1}{R_1} + \frac{1}{R_2} \right) = \frac{V^2}{R_1} + \frac{V^2}{R_2} = P_1 + P_2$

So power consumed in parallel combination is equal to the sum of individual powers.

Question 32: Find the equivalent resistance across A and B in the given figures.

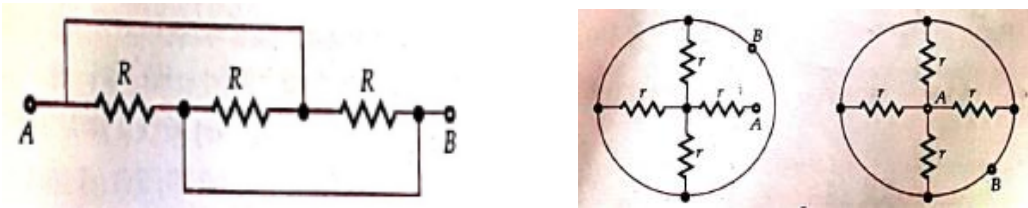

Solution :

(i) The first figure is equivalent to the parallel combination of three resistances each R. So

$$R_{AB} = \frac{R}{3}$$

(ii) The second figure is equivalent to the series combination of one r with the parallel combination of three resistances each r. So $R_{AB} = \frac{r}{3} + r = \frac{4r}{3}$

(iii) The third figure is equivalent to the parallel combination of four resistances each r. So

$$R_{AB} = \frac{r}{4}$$

Question 33: A wire of uniform cross-section has resistance R .

(i) If a wire is bent to form a circle, then find equivalent resistance across a diameter.

(ii) If the wire is bent to form a square, then find equivalent resistance across (a) diagonal & (b) side

(iii) If the wire is bent to form an equilateral triangle, Find equivalent resistance across its side.

Solution :(i) Each half of the circle has resistance $R / 2$ and they are in parallel. $R_{eq} = \frac{R / 2}{2} = \frac{R}{4}$

(ii) Each side of the square has resistance. $R / 4$

(a) Across a diagonal combination is the parallel combination of two arms each having two

$R / 4$ in series. So, $R_{eq} = \frac{(R / 4 + R / 4)}{2} = \frac{R}{4}$

(b) Across its side, the combination is a parallel combination of two arms with one having three $R / 4$ in series and the other having one $R / 4$.

So, $R_{eq} = \frac{(R / 4 + R / 4 + R / 4)(R / 4)}{(R / 4 + R / 4 + R / 4) + (R / 4)} = \frac{(3R / 4)(R / 4)}{R} = \frac{3R}{16}$

(iii) Each side has resistance $R / 3$.

Across a side, the combination is the parallel combination of two arms with one having two $R / 3$ in series and the other having one $R / 3$.

So, $R_{eq} = \frac{(R / 3 + R / 3)(R / 3)}{(R / 3 + R / 3) + (R / 3)} = \frac{(2R / 3)(R / 3)}{R} = \frac{2R}{9}$

Temperature dependence of resistance :

(i) For conductors: As per drift speed concept the resistivity of a conductor is given by $\rho = \frac{m}{ne^2\tau}$

As temperature increases the average relaxation time of free electrons decreases. So resistivity and hence the resistance of a conductor increases with the rise in temperature. Hence the conductivity of the conductor decreases with rising in temperature.

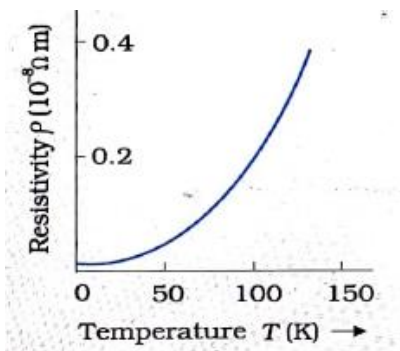

a. For metals (like copper)

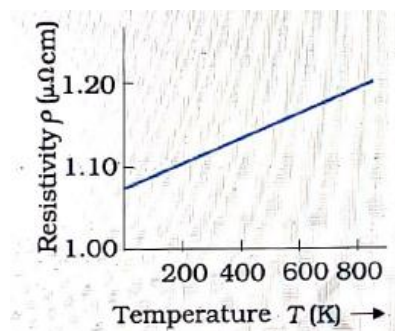

b. For Alloys (like nichrome)

(ii) For semiconductors :

As per the drift speed concept, the resistivity of a conductor is given by $\rho = \frac{m}{ne^2\tau}$

As temperature increases the average relaxation time of free electrons decreases. But for semiconductors no. the density of free electrons increases with the rise in temperature in such a way that the product increases. So resistivity and hence the resistance of the conductor

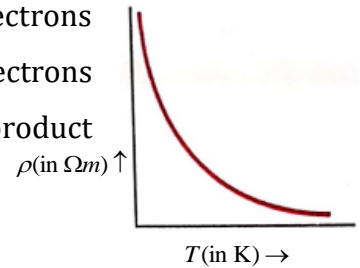

decreases with rising in temperature. Hence the conductivity of the conductor increases with the rise in temperature.

(iii) For insulators: For insulators, the resistivity decreases with rising in temperature.

(iv) Superconductor: There exist some materials whose resistivity decreases on lowering the temperature and below a temperature called the critical temperature there resistivity becomes 0. This property is called superconductivity.

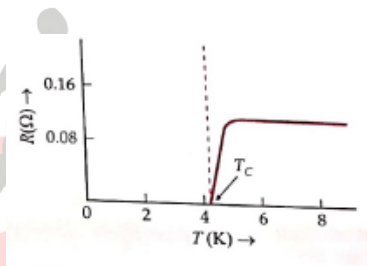

Temperature coefficient of resistance :

The resistance of a conductor varies with temperature. If R_0 and R_t are the resistances of a conductor at 0°C and $t^\circ\text{C}$ respectively, then.

$$R_t = R_0 (1 + t) \qquad = R_0 + R_0 t$$

$$\Rightarrow R_t - R_0 = \alpha R_0 t \qquad \text{i.e. } \Delta R = \alpha R_0 t \qquad \Rightarrow \alpha = \frac{\Delta R}{R_0 t}$$

Hence temperature coefficient of resistance is defined as the change in resistance per unit original resistance at 0°C per unit degree Celsius rise in temperature.

Unit of the temperature coefficient of resistance is K^{-1} or $^\circ\text{C}^{-1}$

If R_1 and R_2 are the resistances of a conductor at temperatures T_1 and T_2 respectively (with $T_2 > T_1$), then $R_2 = R_1 \{1 + \alpha(T_2 - T_1)\}$

Question 34: An electric toaster uses nichrome for its heating element. When a negligibly small current passes through it, its resistance at room temperature is found to be 75.3. When the toaster is connected to a 230 V source, then-current settles after a few seconds to a steady value of 2.68A. What is the steady temperature of the nichrome element? ($\alpha = 1.70 \times 10^{-4} \text{ } ^\circ\text{C}^{-1}$)

(NCERT)

Solution :

$$\text{At, } T_1 = 27^\circ\text{C} \quad R_1 = 75.3\Omega \qquad \text{At temperature, } T_2, \quad R_2 = \frac{230}{2.68}\Omega = 85.8\Omega$$

$$\text{As } \frac{R_2 - R_1}{R_1(T_2 - T_1)} = \alpha \quad \Rightarrow T_2 - T_1 = \frac{R_2 - R_1}{\alpha R_1} = \frac{85.8 - 75.3}{1.7 \times 10^{-4} \times 75.3} \text{ } ^\circ\text{C} = 820^\circ\text{C}$$

$$\Rightarrow T_2 = T_1 + 820^\circ\text{C} = 847^\circ\text{C}$$

Question 35: The resistance of the platinum wire of a platinum resistance thermometer at the ice point 5Ω is and at a steam point is 5.39Ω . When the thermometer is inserted into a hot bath, the resistance of the platinum wire is 5.795Ω . Calculate the temperature of the bath. (NCERT)

$$\text{Solution: As } R_{100^\circ\text{C}} - R_{0^\circ\text{C}} = \alpha R_{0^\circ\text{C}}(100^\circ\text{C} - 0^\circ\text{C}) \Rightarrow \alpha = \frac{R_{100^\circ\text{C}} - R_{0^\circ\text{C}}}{R_{0^\circ\text{C}}(100^\circ\text{C} - 0^\circ\text{C})} = \frac{R_{100^\circ\text{C}} - R_{0^\circ\text{C}}}{R_{0^\circ\text{C}}(100^\circ\text{C})}$$

$$\text{At any temperature } T, \quad R_T - R_{0^\circ\text{C}} = \alpha R_{0^\circ\text{C}}(T^\circ\text{C} - 0^\circ\text{C})$$

$$\Rightarrow T = \frac{R_T - R_{0^\circ\text{C}}}{\alpha R_{0^\circ\text{C}}} = \frac{1}{\alpha} \times \frac{R_T - R_{0^\circ\text{C}}}{R_{0^\circ\text{C}}} = \frac{100^\circ\text{C} \times R_{0^\circ\text{C}}}{R_{100^\circ\text{C}} - R_{0^\circ\text{C}}} \times \frac{R_T - R_{0^\circ\text{C}}}{R_{0^\circ\text{C}}} = \frac{100^\circ\text{C}(R_T - R_{0^\circ\text{C}})}{R_{100^\circ\text{C}} - R_{0^\circ\text{C}}}$$

$$\Rightarrow T = \frac{100^\circ\text{C}(5.795 - 5)}{5.39 - 5} = \frac{100^\circ\text{C}(0.795)}{0.39} = 203.8^\circ\text{C}$$

Question 36: Choose the correct alternative:

- (a) Alloys of metals usually have (greater/less) resistivity than that of their constituent metals.
- (b) Alloys usually have much (lower/higher) temperature coefficients of resistance than pure metals.

- (c) The resistivity of the alloy managing (is nearly independent of/ increases rapidly with) increases in temperature.
- (d) The resistivity of a typical insulator (e.g., amber) is greater than that of a metal by a factor of the order of $(10^{22}/10^{23})$.

Solution : (a) greater (b) lower (c) is early independent of (d) 10^{23}

Question 37: The figure shows I ~ V graphs A and B for a conductor at temperatures T_1 and T_2 respectively. Which is greater out of T_1 and T_2 ? Why?

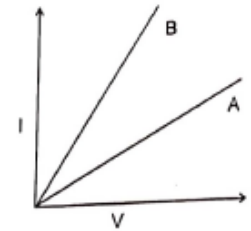

Solution: From the figure, $R_A > R_B$

Since resistance is higher at a higher temperature. Hence $T_1 > T_2$.

Cell:- Cell is a device that is used in electric dc circuits to supply electrical power or current or to maintain a constant potential difference across the resistances. Its circuit symbol is as shown in the circuit between A and B. A group of cells is called a battery.

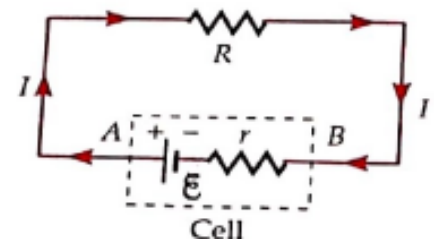

Electromotive Force (emf): The e.m.f of a cell is defined as the work done by the cell in moving unit positive charge in the whole circuit including cell.

It is not a force but maximum work done in taking a unit charge once around the closed circuit.

The electromotive force is associated with an arrangement or mechanism which can supply energy to move the electric charge from a lower potential point to a higher potential point. Such an arrangement is called a source of e.m.f, which may be a cell, a battery, a generator, or dynamo.

If W is the work done by a cell in moving a charge q once around a circuit including the cell then

$$\text{emf of the cell is } \xi = \frac{W}{q}$$

S. I unit of emf **Joule / Coulomb** and is called **volt**. Its dimensional formula is $[M^1L^2T^{-3}A^{-1}]$

The emf of a cell depends only on the nature of electrodes and electrolytes and is constant for a given type of cell.

Mechanism of emf :

Let P be the positive electrode and N be the negative electrode.

A is a point of electrolyte very close to P and B is a point of electrolyte very close to N.

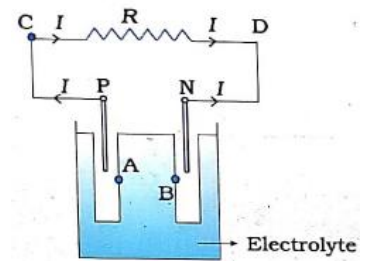

As the electrolyte is dissociated then positive ions and negative ions are formed. Due battery force +ve ions move towards P and gathered there and -ve ions move towards N and gathered there. So the potential of P becomes greater than A and the potential of N becomes less than that of N.

Let $V_+ = V_P - V_A$ and $V_- = V_B - V_N$ (i)

In open circuit there is no current . So $V_A = V_B$

Now $V_P - V_N = (V_P - V_A) + (V_A - V_B) + (V_B - V_N)$

$= (V_P - V_A) + (V_B - V_N)$

$= V_+ + V_-$

{ Using eq.(i) and $V_A = V_B$ }

This potential difference is emf (ξ). So $\xi = V_+ + V_-$ (ii)

During discharging of cells the electrodes are connected by a resistance R. Outside the cell current flows from +ve terminal to -ve terminal and inside the cell current flows from -ve terminal to +ve terminal.

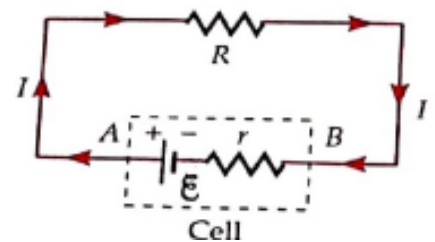

So $V = \xi - Ir$ (iii)

This is the relation between emf and terminal potential difference during discharging.

The expression for internal resistance :

As resistance R is in parallel with the cell so potential difference across it is also V.

So $V = IR$ (iv)

Using eq.(iv) in eq.(iii) we get $IR = \xi - Ir \Rightarrow \xi = I(R + r)$ (v)

Again from eq. (iii) $r = \frac{\xi - V}{I} = \frac{\xi - V}{\frac{V}{R}} = \left(\frac{\xi - V}{V}\right)R$ (vi) .

This is an expression of internal resistance.

During the charging of cells, the electrodes are connected by a charging source of high voltage V. So +ve ions flow towards P from +ve terminal of the source and -ve ions flow towards N from -ve terminal of the source. So in the cell +ve ions flow from P to A, A to B, and then from B to N.

Hence $V = \xi + Ir$

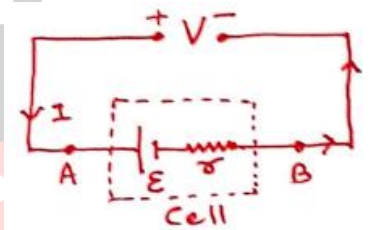

In an open circuit, there is no current. So $V = \xi$

When the cell is short-circuited :

External resistance between P and N is zero i.e. $R = 0$

In this situation $I = \frac{\xi}{0+r} = \frac{\xi}{r}$

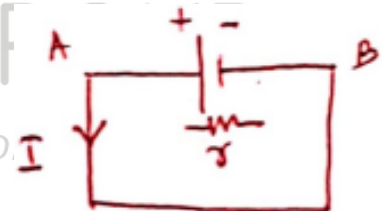

i.e. short circuit current of a cell is maximum while the terminal voltage is zero.

Question 38: A cell of emf ξ and internal resistance r is connected across a variable resistance R as shown in the figure. Current in the circuit is I. Show graphically the variations between

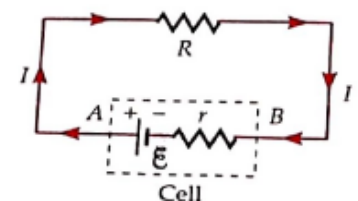

- (i) ξ and R
- (ii) V and I
- (iii) V and R
- (iv) I and R

Solution :

(i) As ξ is independent of R , so the graph is

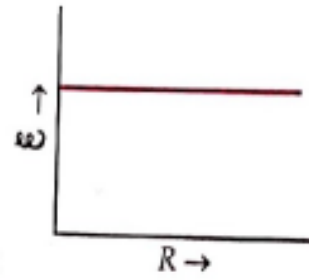

(ii) Since $V = \xi - Ir = -rI + \xi$

So the graph between V and I is a straight line

with slope = $-r$

y-intercept = ξ

x-intercept = $\frac{\xi}{r}$

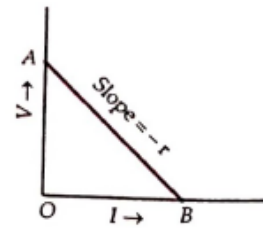

(iii) Since $V = IR = \frac{\xi R}{r+R} = \frac{\xi}{1+r/R}$

For $R = 0 \Rightarrow V = \frac{\xi}{1+r/0} = \frac{\xi}{\infty} = 0$

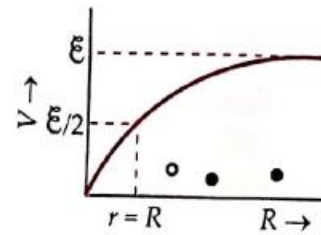

For $R = \infty \Rightarrow V = \frac{\xi}{1+r/\infty} = \xi$

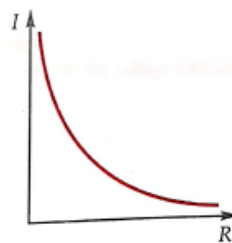

(iv) Since $I = \frac{\xi}{r+R}$

For $R = 0 \Rightarrow I = \frac{\xi}{r+0} = \frac{\xi}{r}$

For $R = \infty \Rightarrow I = \frac{\xi}{r+\infty} = \frac{\xi}{\infty} = 0$

Question 39: The storage battery of a car has an emf of 12 V. If the internal resistance of the battery is 0.4Ω , what is the maximum current that can be drawn from the battery? (NCERT)

Solution :

The current will be maximum when the cell is shorted.

$$\text{So } I_{\max} = \frac{\xi}{r} = \frac{12\text{V}}{0.4\Omega} = 30\text{A}$$

Question 40: A battery of emf 10 V and internal resistance 3 Ω is connected to a resistor. If the current in the circuit 0.5 A, what is the resistance of the resistor? What is the terminal voltage of the battery when the circuit is closed?

(NCERT)

Solution: As $\xi = I(r + R) \Rightarrow R = \frac{\xi}{I} - r = \frac{10}{0.5} - 3 = 20 - 3 = 17\Omega$

Question 41: A network of resistors is connected to a 16 V battery with an internal resistance of 1Ω, as shown in figure

- (a) Compute the equivalent resistance of the network.
- (b) Obtain the current in each resistor.
- (c) Obtain the voltage drops V_{AB} , V_{BC} , and V_{CD} . (NCERT)

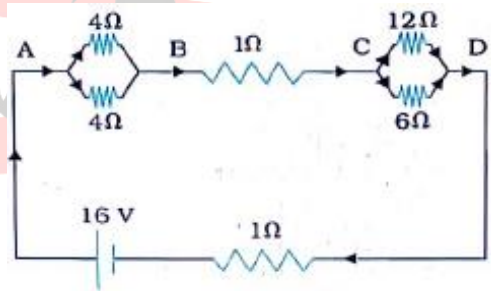

Solution :

Changing your Tomorrow

(a) The network is a simple series and parallel combination of resistors. First the two 4 Ω resistors in parallel are equivalent to a resistor = $[(4 \times 4)/(4 + 4)] \Omega = 2 \Omega$. In the same way, the 12 Ω and 6 Ω resistors in parallel are equivalent to a resistor of $[(12 \times 6)/(12 + 6)] \Omega = 4 \Omega$. The equivalent resistance R of the network is obtained by combining these resistors (2 Ω and 4 Ω) with 1 Ω in series, that is, $R = 2 \Omega + 4 \Omega + 1 \Omega = 7 \Omega$.

(b) $I = \frac{\xi}{r + R} = \frac{16}{1 + 7} \text{A} = 2\text{A}$

At the junction, A current is equally divided and passes through each 4Ω resistor. So current

through each 4Ω resistor is $\frac{I}{2} = \frac{2}{2} \text{A} = 1\text{A}$

At the junction, the current is divided into the ratio 6:12 i.e. 1:2 and 1 part flows through 12Ω the resistor and 2 part through 6Ω a resistor .

$$\text{So current through } 12\Omega \text{ resistor} = \frac{1}{3}I = \frac{2}{3}\text{A}$$

$$\text{Current through } 6\Omega \text{ resistor} = \frac{2}{3}I = \frac{4}{3}\text{A}$$

$$(c) V_{AB} = I_1 \times 4\Omega = 1\text{A} \times 4\Omega = 4\text{V}, V_{BC} = I \times 1\Omega = 2 \times 1\text{V} = 2\text{V} \text{ and } V_{CD} = I_3 \times 12\Omega = \frac{2}{3} \times 12\text{V} = 8\text{V}$$

Question 42: The figure shows $V \sim I$ graph for a cell connected across a variable external resistance.

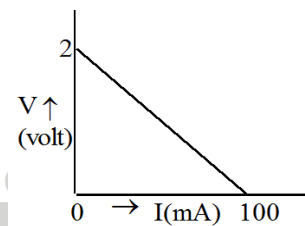

- (a) Obtain emf and internal resistance of the cell.
- (b) How much power must be dissipated from the external resistance when it is equal to the internal resistance of the cell.

Solution :

- (a) In the graph between v and I of a cell, the y-intercept is emf (ξ) and the x-intercept is $\frac{\xi}{r}$.

$$\text{So; } \xi = 2\text{V} \text{ and } \Rightarrow r = \frac{\xi}{0.1\text{A}} = \frac{2\text{V}}{0.1\text{A}} = 20\Omega$$

- (b) When $R = r = 20\Omega$ then $I = \frac{\xi}{r + R} = \frac{2\text{V}}{40\Omega} = \frac{1}{20}\text{A}$

$$\therefore P = I^2 R = \left(\frac{1}{20}\text{A}\right)^2 \times 20\Omega = \frac{1}{20}\text{W} = 50\text{mW}$$

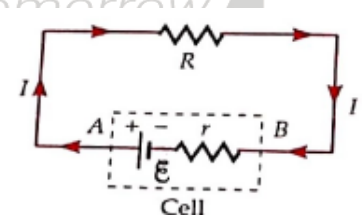

Question 43: A variable resistance R is connected across a cell of emf E and internal resistance r .

- (a) Obtain an expression for current through R and power dissipated from R .
- (b) When will the current be minimum? Find the minimum current. What is the power dissipation in this case?
- (c) When will the power dissipation be maximum? What is the maximum power dissipated? What is the current in this case?

Solution :

$$(a) I = \frac{E}{r+R} \quad \text{and} \quad P = I^2 R = \left(\frac{E}{r+R} \right)^2 R = \frac{E^2 R}{(r+R)^2}$$

(b) Current will be maximum when $R = 0$

Maximum current; $I_{\max} = \frac{E}{r}$ and power dissipation in this case is; $P = I_{\max}^2 \times 0 = 0$

(c) For power to be maximum; $\frac{dP}{dR} = 0$

$$\Rightarrow \frac{d}{dR} \left(\frac{E^2 R}{(r+R)^2} \right) = 0 \Rightarrow \frac{(r+R)^2 \cdot E^2 - E^2 R \cdot 2(r+R)}{(r+R)^4} = 0$$

$$\Rightarrow \frac{E^2 (r+R)}{(r+R)^4} (r+R - 2R) = 0 \Rightarrow r - R = 0 \Rightarrow r = R$$

Hence maximum power will be transferred if external resistance will be equal to the internal resistance of the cell. This is a maximum power transfer theorem.

$$\therefore P_{\max} = \frac{E^2 R}{(R+R)^2} = \frac{E^2}{4R} = \frac{E^2}{4r}, \quad \text{and current in this case is ; } I = \frac{E}{2r} = \frac{E}{2R} = \frac{I_{\max}}{2}$$

Question 44: A cell of emf E and internal resistance r sends current I_1 when connected across R_1 and sends current I_2 when connected across R_2 . Find expressions for E and r .

Solution : From given information's we can have ; $I_1 = \frac{E}{r+R_1}$ and $I_2 = \frac{E}{r+R_2}$

$$\Rightarrow \frac{I_1}{I_2} = \frac{E}{r+R_1} \times \frac{r+R_2}{E} \Rightarrow I_1 r + I_1 R_1 = I_2 r + I_2 R_2$$

$$\Rightarrow (I_1 - I_2)r = I_1 R_1 + I_2 R_2 \Rightarrow r = \frac{I_1 R_1 + I_2 R_2}{I_1 - I_2}$$

Now using the expression of r in the equation, $E = I_1 R_1 + I_1 r$ we can get $E = \frac{I_1 I_2 (R_2 - R_1)}{I_1 - I_2}$

Question 44: What is the efficiency of a cell? What will be its efficiency while delivering maximum power?

Solution :

For a given cell, input power = EI (where E = its emf, I = current through the cell)

Output power = VI (where V = its terminal potential difference)

$$\text{So its efficiency ; } \eta = \frac{P_{\text{out}}}{P_{\text{in}}} = \frac{VI}{EI} = \frac{V}{E} = \frac{IR}{I(R+r)} = \frac{R}{(R+r)}$$

Where R = external resistance and r = internal resistance

When maximum power is delivered, $r = R$

Question 45: Answer the following questions :

- (a) A steady current flows in a metallic conductor of a non-uniform cross-section. Which of the quantities is constant along the conductor: current, current density, electric field, drift speed?
- (b) Is Ohm's law universally applicable for all conducting elements? If not, give examples of elements that don't obey Ohm's law.
- (c) A low voltage supply from which one needs high currents must have very low internal resistance. Why?
- (d) A high tension (HT) supply of , say 6 kV must have a very large internal resistance . Why ?

(NCERT)

Solution :

(a) Current

(b) No. Conductors at high temperature, junction diode, GaAs don't obey Ohm's law.

(c) As maximum current is drawn from a source $= \frac{\xi}{r}$

(d) If accidentally the circuit is shorted, the current drawn will exceed the safety limit and will cause damage to the circuit. Therefore a high tension supply must have a large internal resistance.

Series combination of cells :

In a series combination of cells, the current through each cell is the same and the potential

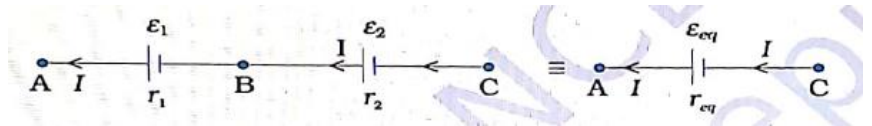

difference of the combination is equal to the sum of the potential difference of individual cells.

Let two cells of EMFs ξ_1 and ξ_2 with internal resistances, r_1 and r_2 respectively are in series across a resistance R .

I = current through the combination.

So the voltage across individual cells $V_1 = \xi_1 - Ir_1$ and $V_2 = \xi_2 - Ir_2$

Now for equivalent circuit $V = \xi_{eq} - Ir_{eq}$

As in series combination $V = V_1 + V_2$

$$\Rightarrow \xi_{eq} - Ir_{eq} = \xi_1 - Ir_1 + \xi_2 - Ir_2 = (\xi_1 + \xi_2) - I(r_1 + r_2) \Rightarrow \xi_{eq} = \xi_1 + \xi_2 \text{ and } r_{eq} = r_1 + r_2$$

So current in the circuit is
$$I = \frac{\xi_{eq}}{r_{eq} + R} = \frac{\xi_1 + \xi_2}{(r_1 + r_2) + R}$$

For large no. of cells in series $\xi_{eq} = \xi_1 + \xi_2 + \dots$ and $r_{eq} = r_1 + r_2 + \dots$ And $I = \frac{\xi_{eq}}{r_{eq} + R}$

For cells being wrongly connected, their EMFs are taken to be negative but internal resistances are positive. E.g.



In the given figure net emf = $(10-4)V = 6V$,

but net internal resistance = $r_1 + r_2$

For n identical cells in series $\xi_{eq} = n\xi$, $r_{eq} = nr$ and $I = \frac{n\xi}{nr + R}$

(i) For new cells internal resistance is negligible i.e. $nr \ll R$.

So current in the circuit is $I = \frac{n\xi}{R} = n$ times current due to one cell

(ii) For old cells internal resistance is very high in comparison to the external resistance, So $nr \gg R$.

So current in the circuit is $I = \frac{n\xi}{nr} = \frac{\xi}{r} =$ current due to one

cell

Question 43: In the given circuit cells E_1 and E_2 have EMFs 3V and 5V respectively and internal resistances 0.3Ω and 1.2Ω respectively. Find the current through the circuit.

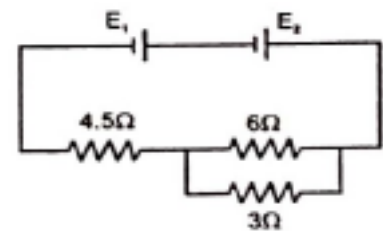

Solution: For the given circuit ; $E_{eq} = E_1 + E_2 = 3V + 5V = 8V$

$$r_{eq} = r_1 + r_2 = 0.3\Omega + 1.2\Omega = 1.5\Omega$$

$$R_{eq} = 4.5\Omega + \frac{6 \times 3}{6 + 3}\Omega = 6.5\Omega \quad \text{So current is ; } I = \frac{E_{eq}}{r_{eq} + R_{eq}} = \frac{8V}{1.5\Omega + 6.5\Omega} = 1A$$

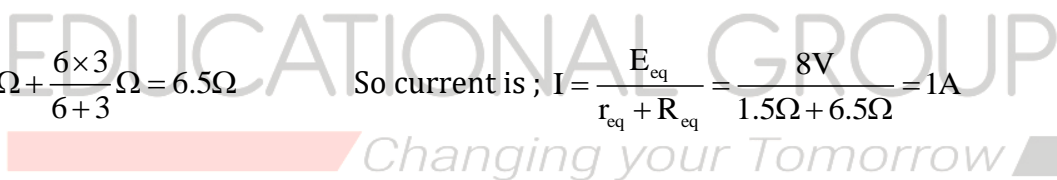

The parallel combination of cells :

In a parallel combination of cells, the potential difference of each cell is the same, and current through the combination is equal to the sum of the current through individual cells.

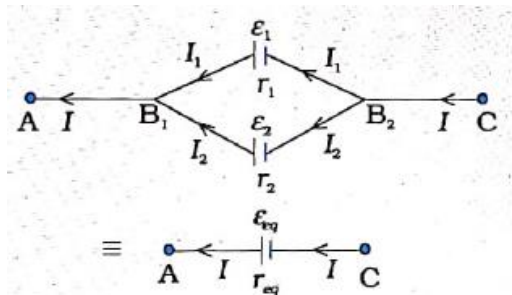

Let two cells of EMFs ξ_1 and ξ_2 with internal resistances, r_1 and r_2 respectively are in parallel across a resistance R .

$I =$ current through the combination.

$$\text{For the first cell } V = \xi_1 - I_1 r_1 \quad \Rightarrow I_1 = \frac{\xi_1 - V}{r_1} = \frac{\xi_1}{r_1} - \frac{V}{r_1}$$

Similarly for the second cell $I_2 = \frac{\xi_2}{r_2} - \frac{V}{r_2}$

Now for equivalent circuit $I = \frac{\xi_{eq}}{r_{eq}} - \frac{V}{r_{eq}}$

As in parallel combination $I = I_1 + I_2 \Rightarrow$

$$\frac{\xi_{eq}}{r_{eq}} - \frac{V}{r_{eq}} = \frac{\xi_1}{r_1} - \frac{V}{r_1} + \frac{\xi_2}{r_2} - \frac{V}{r_2} = \left(\frac{\xi_1}{r_1} + \frac{\xi_2}{r_2} \right) - V \left(\frac{1}{r_1} + \frac{1}{r_2} \right)$$

$$\Rightarrow \frac{1}{r_{eq}} = \frac{1}{r_1} + \frac{1}{r_2} \Rightarrow r_{eq} = \frac{r_1 r_2}{r_1 + r_2}$$

$$\text{And } \frac{\xi_{eq}}{r_{eq}} = \frac{\xi_1}{r_1} + \frac{\xi_2}{r_2} \Rightarrow \frac{\xi_{eq}}{r_{eq}} = \frac{\xi_1 r_2 + \xi_2 r_1}{r_1 r_2} \Rightarrow \frac{\xi_{eq}}{r_1 r_2 / (r_1 + r_2)} = \frac{\xi_1 r_2 + \xi_2 r_1}{r_1 r_2} \Rightarrow \xi_{eq} = \frac{\xi_1 r_2 + \xi_2 r_1}{r_1 + r_2}$$

Current in the circuit is $I = \frac{\xi_{eq}}{r_{eq} + R}$

For large no. of cells in parallel, $\frac{1}{r_{eq}} = \frac{1}{r_1} + \frac{1}{r_2} + \frac{1}{r_3} + \dots \dots \dots \frac{E_{eq}}{r_{eq}} = \frac{E_1}{r_1} + \frac{E_2}{r_2} + \frac{E_3}{r_3} + \dots \dots \dots$ And $I = \frac{\xi_{eq}}{r_{eq} + R}$

For cells being wrongly connected, their EMFs are taken to be negative but internal resistances are positive.

For n identical cells in parallel $\frac{1}{r_{eq}} = \frac{1}{r} + \frac{1}{r} + \dots \dots \dots n \text{ times} = \frac{n}{r} \Rightarrow r_{eq} = \frac{r}{n}$

$$\frac{\xi_{eq}}{r_{eq}} = \frac{\xi}{r} + \frac{\xi}{r} + \dots \dots \dots n \text{ times} = \frac{n\xi}{r} \Rightarrow \frac{\xi_{eq}}{r/n} = \frac{n\xi}{r} \Rightarrow \frac{n\xi_{eq}}{r} = \frac{n\xi}{r} \Rightarrow \xi_{eq} = \xi$$

Current through the circuit is $I = \frac{\xi_{eq}}{r_{eq} + R} = \frac{\xi}{\frac{r}{n} + R} = \frac{n\xi}{r + nR}$

(i) For new cells internal resistance is negligible. So $r \ll nR$.

So current in the circuit is $I = \frac{n\xi}{nR} = \frac{\xi}{R}$ = current due to one cell

(ii) For old cells internal resistance is very high in comparison to the external resistance, So $r \gg nR$.

So current in the circuit is $I = \frac{n\xi}{r} = n$ times current due to one cell

Mixed grouping of m x n identical cells each of emf ξ and internal resistance r in m rows with each row carrying n cells :

In the combination, each row is equivalent to a series combination of n identical cells each of emf ξ and internal resistance r.

So equivalent emf of each row is $\xi_s = n\xi$ the internal resistance of each row is $r_s = nr$

Now the combination is equivalent to a parallel grouping of identical cells each of emf ξ_s and internal resistance r_s .

So equivalent emf is $\xi_{eq} = \xi_s = n\xi$ and equivalent internal resistance is $r_{eq} = \frac{r_s}{m} = \frac{nr}{m}$

So current in the circuit is $I = \frac{\xi_{eq}}{r_{eq} + R} = \frac{n\xi}{\frac{nr}{m} + R} = \frac{mn\xi}{nr + mR}$ (i)

Condition for maximum current :

Now $nr + mR = (\sqrt{nr})^2 + (\sqrt{mR})^2 = (\sqrt{nr} - \sqrt{mR})^2 + 2\sqrt{nr mR}$ (ii)

For current to be maximum, $(nr + mR)$ is to be minimum as per equation (i). From equation

(ii) we get that $(nr+mR)$ will be minimum if $(\sqrt{nr} - \sqrt{mR})^2 = 0 \Rightarrow nr = mR \Rightarrow R = \frac{nr}{m}$

This is the condition for the maximum current. Using the condition in equation (i) we get the

maximum current to be $I_{max} = \frac{mn\xi}{nr + nr} = \frac{m\xi}{2r}$ or $I_{max} = \frac{mn\xi}{mR + mR} = \frac{n\xi}{2R}$

Question 44: In the given circuit find the charge and energy stored in the capacitor at a steady state.

Solution :

In the figure, there is no current through arm BE.

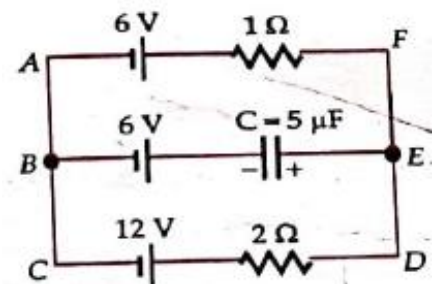

So the total current is, $I = \frac{12V - 6V}{2\Omega + 1\Omega} = 2A$

So, $V_{AF} = V_{BE} = V_{CD} = 12V - 2A \times 2\Omega = 8V$

Voltage across capacitor = $8V - 6V = 2V$

$\therefore q = CV = 5\mu F \cdot 2V = 10\mu C$ and $U = \frac{1}{2} CV^2 = \frac{1}{2} 5\mu F (2V)^2 = 10\mu J$

Question 45: Two cells of EMFs 1V and 2V with internal resistance 2Ω and 1Ω respectively are connected in series and parallel across the same resistor separately. Find the external resistance so that current through it in both cases is the same .

Solution: In series, $I_s = \frac{E_1 + E_2}{r_1 + r_2 + R} = \frac{1 + 2}{2 + 1 + R} = \frac{3}{3 + R}$

In parallel, $E_p = \frac{E_1 r_2 + E_2 r_1}{r_1 + r_2} = \frac{1 \times 1 + 2 \times 2}{2 + 1} V = \frac{5}{3} V$ and $r_p = \frac{r_1 r_2}{r_1 + r_2} = \frac{2 \times 1}{2 + 1} \Omega = \frac{2}{3} \Omega$

$\therefore I_p = \frac{E_p}{r_p + R} = \frac{5/3}{2/3 + R} = \frac{5}{2 + 3R}$ As $I_s = I_p$

$\Rightarrow \frac{3}{3 + R} = \frac{5}{2 + 3R} \Rightarrow R = \frac{9}{4} \Omega$

Question 46: Twelve identical cells each of emf 1.5 V and internal resistance 1Ω are connected in m rows with each row containing n cells across an external resistance of 3Ω . Find the values of m and n to get maximum current through external resistance. What is the maximum current?

Solution :

For maximum current, $R / r = n / m \Rightarrow n / m = 3 / 1 = 3$

Total number of cells is ; $mn = 12$

Now, $mn \times n / m = 12 \times 3 \Rightarrow n^2 = 36$

$\Rightarrow n = 6 \Rightarrow m = 2$

Now $I_{max} = \frac{mnE}{mR + nr} = \frac{2 \times 6 \times 1.5}{2 \times 3 + 6 \times 1} A = \frac{18}{12} A = 1.5A$

Kirchhoff's laws :**Kirchhoff's current law (Junction rule) :**

In an electric circuit total current entering a junction is equal to the total current leaving a junction.

Proof :

Kirchhoff's current law is the consequence of the conservation of charge.

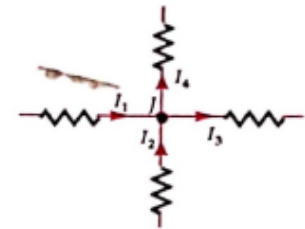

As total charge at every point is always constant

$$\text{So } \frac{dq}{dt} = 0$$

$$\Rightarrow \sum I = 0 \text{ at every junction}$$

$$\Rightarrow \sum I_{\text{entering}} = \sum I_{\text{leaving}}$$

e.g.: In the given figure by Kirchhoff's current law (KCL); $I_1 + I_2 = I_3 + I_4$

Question 47: In the given figure what is the current through the arm shown

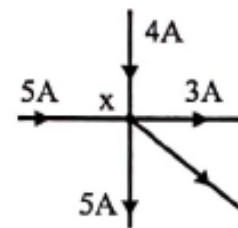

Solution :

$$\text{Unknown current} = 5A + 4A - 5A - 3A = 1A$$

Kirchhoff's voltage law (Loop rule) :

In an electric circuit algebraic sum of potential difference across all cells and resistive elements across a closed loop is zero.

Proof :

Kirchhoff's voltage law is the consequence of the conservation of energy.

As the total energy of a charge in a closed loop is always constant, so change in its energy around a closed loop is 0. As the change in energy of a charge = $q \sum \Delta V$

$$\Rightarrow \sum \Delta V = 0 \quad \Rightarrow \sum \Delta V = 0$$

OR

Consider any closed loop ABCDEA. Different elements are present in the loop. Between A and B, between B and C, between C and D, between D and E, Between E and A, there are elements.

Now potential difference across the loop is

$$\begin{aligned} \sum \Delta V &= (V_A - V_B) + (V_B - V_C) + (V_C - V_D) + (V_D - V_E) + (V_E - V_A) \\ &= V_A - V_B + V_B - V_C + V_C - V_D + V_D - V_E + V_E - V_A = 0 \end{aligned}$$

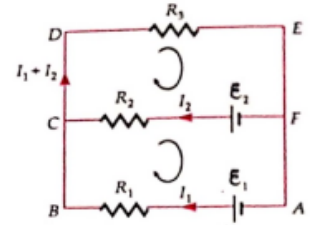

e.g.: In the given figure by Kirchoff's voltage law (KVL) in the loop ABCFA,

$$\xi_1 - I_1 R_1 - \xi_2 + I_2 R_2 = 0 \quad \text{In the loop CDEFC, } \xi_2 - I_2 R_2 - (I_1 + I_2) R_3 = 0$$

Wheat stone bridge:

The wheat stone bridge consists of four resistances P, Q, R, and S between the points A and B, between B and C, between A and D, between D and C respectively. A cell is connected across A and C through a tapping key K. A galvanometer is connected across B and D. As the switch K is closed current I passes through the cell and distributed according to Kirchoff's current law.

Now using KVL

Changing your Tomorrow

In loop ABDA, $I_1 P + I_g G - (I - I_1) R = 0$ (i)

In loop BCDB, $(I_1 - I_g) Q - (I - I_1 + I_g) S - I_g G = 0$ (ii)

Wheat stone bridge is said to be balanced when galvanometer

shows no deflection . i.e. $I_g = 0$ (iii)

Using the condition (iii) in eq.(i) and (ii) we get

eq.(i) $\Rightarrow I_1 P - (I - I_1) R = 0 \Rightarrow I_1 P = (I - I_1) R$ (iv)

eq.(ii) $\Rightarrow I_1 Q - (I - I_1) S = 0 \Rightarrow I_1 Q = (I - I_1) S$ (v)

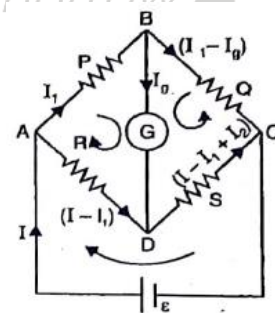

Dividing eq.(iv) by eq.(v) we get $\frac{P}{Q} = \frac{R}{S}$.

This is the balanced condition of the wheat-stone bridge.

At the balanced condition, net resistance of the circuit is $R_{eq} = \frac{(P+Q)(R+S)}{P+Q+R+S}$

Current through the cell is $I = \frac{\xi(P+Q+R+S)}{(P+Q)(R+S)}$ (if the cell of emf has no internal resistance)

$$I = \frac{\xi(P+Q+R+S)}{(P+Q)(R+S) + r(P+Q+R+S)} \text{ (if the cell of emf has internal resistance } r \text{)}$$

r)

If the positions of cell and galvanometer are altered then the balanced condition becomes

$$\frac{R}{P} = \frac{S}{Q} \Rightarrow \frac{R}{S} = \frac{P}{Q}$$

Hence the balanced condition is not affected by alternating the positions of cell and galvanometer.

Question 48: In the given figure what is the current through

(i) Galvanometer

(ii) Cell. What happens to the current through galvanometer if its position is interchanged with that of a cell?

Solution :

(i) As $\frac{R_{AB}}{R_{BC}} = \frac{R_{AD}}{R_{DC}}$ the bridge is balanced. So current through galvanometer = 0

(ii) $R_{eq} = \frac{(10+5)(10+5)}{(10+5)+(10+5)} = 7.5\Omega$

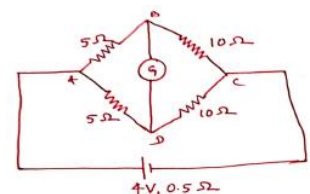

So current through the cell is, $I = \frac{E}{r+R} = \frac{4}{0.5+7.5} \text{ A} = 0.5\text{A}$

If the positions of cell and galvanometer are interchanged then there is no effect to balancing condition i.e. current through galvanometer is 0.

Question 49: In the given figures find the equivalent resistance between A and B (if all the resistances has shown are R each)

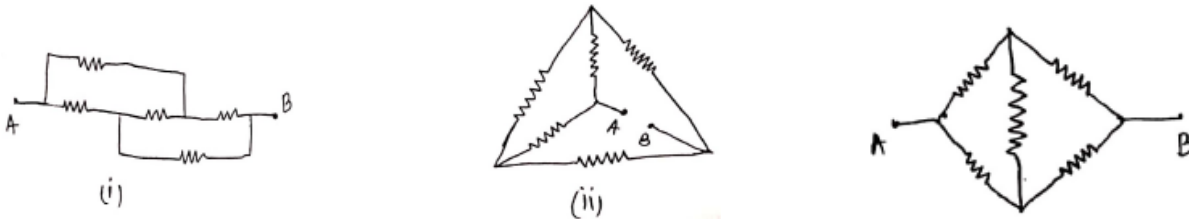

Solution: All the networks shown in the figures are balanced wheat stone bridge.

So equivalent resistance across AB in each case is; $R_{AB} = \frac{(R + R)(R + R)}{(R + R) + (R + R)} = R$

Question 50: In the given figures find the equivalent resistance between A and B

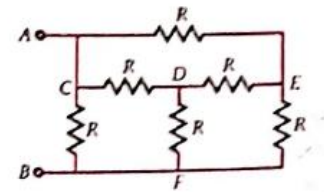

Solution: The equivalent networks of the given network is as shown.

So, $\frac{1}{R_{AB}} = \frac{1}{2R} + \frac{1}{2R} + \frac{1}{R} = \frac{4}{2R}$

$\Rightarrow R_{AB} = \frac{R}{2}$

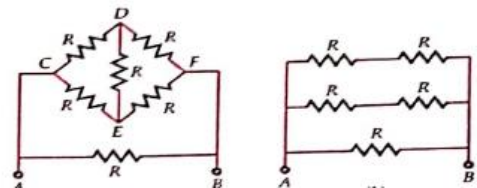

Question 51: Using Kirchoff's laws obtain equivalent resistance across A and of the given network.

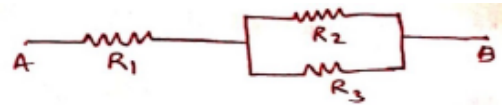

Solution: Assume a cell Of potential difference V across A and B . Now current is distributed along different arms. By using KCL. $I = I_1 + I_2 \Rightarrow I_2 = I - I_1$

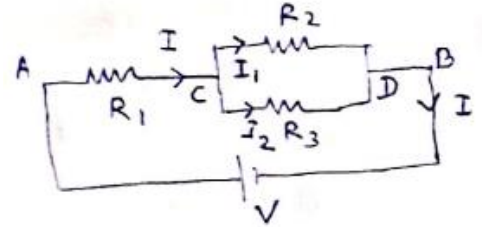

Using KVL in the loop ACR_2DBVA ;

$$IR_1 + I_1R_2 = V \dots(i)$$

In the loop ACR_3DBVA ;

$$IR_1 + I_2R_3 = V \Rightarrow IR_1 + (I - I_1)R_3 = V \Rightarrow I(R_1 + R_3) - I_1R_3 = V \dots(ii)$$

Now eliminating I_1 from equations (i) and (ii) we have,

$$I\{R_1R_3 + (R_1 + R_3)R_2\} = V(R_3 + R_2)$$

$$\Rightarrow \frac{V}{I} = \frac{R_1R_3 + (R_1 + R_3)R_2}{R_3 + R_2} = \frac{R_1R_3 + R_1R_2 + R_2R_3}{R_3 + R_2} \text{ Since } \frac{V}{I} = R_{eq} \Rightarrow R_{eq} = \frac{R_1R_3 + R_1R_2 + R_2R_3}{R_3 + R_2}$$

Note: Using this method we can find equivalent resistance for series and parallel combination.

Question 52: Using Kirchoff's laws obtain equivalent emf and internal resistance of two cells in series.

Solution: Assume an external resistance R across the combination.

Now by using KVL in the loop we have,

$$E_1 + E_2 = I(r_1 + r_2 + R) \dots(i)$$

$$\text{As for cell; } E_{eq} = I(r_{eq} + R) \dots(ii)$$

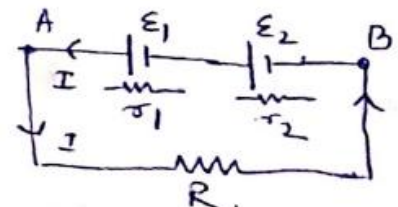

Comparing equation (i) and (ii) we have

$$E_{eq} = E_1 + E_2 \text{ and } r_{eq} = r_1 + r_2$$

Note: Using this method we can find equivalent emf and internal resistance of cells in series and parallel combination.

Question 53: Using Kirchhoff's laws obtain the values of I_1, I_2 and I_3 , and in the given figure.

Solution: In the figure using KCL; $I_3 = I_1 + I_2$(i)

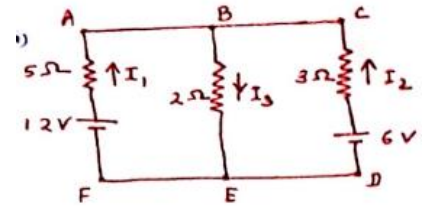

Using KVL in the loop ABEFA;

$$5I_1 + 2I_3 = 12 \Rightarrow 5I_1 + 2(I_1 + I_2) = 12 \Rightarrow 7I_1 + 2I_2 = 12 \dots(ii)$$

In the loop BCDEB;

$$3I_2 + 2I_3 = 6 \Rightarrow 3I_2 + 2(I_1 + I_2) = 6 \Rightarrow 2I_1 + 5I_2 = 6 \dots(iii)$$

On solving equations (ii) and (iii) we have $I_1 = \frac{48}{31} \text{ A}$ and $I_2 = \frac{18}{31} \text{ A}$

Using the values in equation (i) we have ; $I_3 = I_1 + I_2 = \frac{48}{31} \text{ A} + \frac{18}{31} \text{ A} = \frac{66}{31} \text{ A}$

Question 54: Using Kirchhoff's laws obtain the potential difference across each cell and also find the rate of energy dissipation in R.

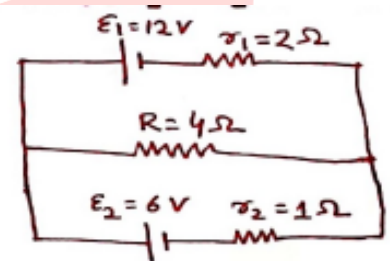

Solution :

Using KCL current is distributed and shown in the figure.

Using KVL in the loop ABCDA ;

$$4(I_1 + I_2) + 2I_1 = 12 \Rightarrow 6I_1 + 4I_2 = 12 \Rightarrow 3I_1 + 2I_2 = 6 \dots(i)$$

Using KVL in the loop CDEFC; $4(I_1 + I_2) + 1.I_2 = 6 \Rightarrow 4I_1 + 5I_2 = 6 \dots(ii)$

Solving equations (i) and (ii) we get

$$I_1 = \frac{18}{7} \text{ A} \text{ and } I_2 = -\frac{6}{7} \text{ A} \quad \text{i.e. } \frac{6}{7} \text{ A from E to F.}$$

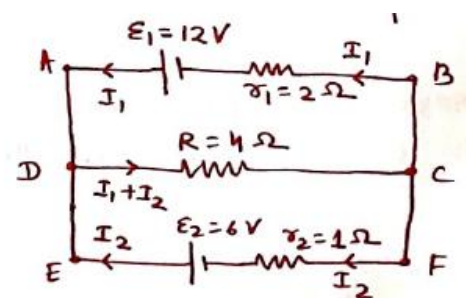

$$\therefore V_{AB} = E_1 - I_1 r_1 = 12 - \frac{18}{7} \times 2 = \frac{48}{7} \text{ V} = V_{EF}$$

$$\therefore P_{4\Omega} = (I_1 + I_2)^2 \times 4\Omega = \left(\frac{12}{7} \text{ A}\right)^2 \times 4\Omega = \frac{576}{49} \text{ W}$$

Question 55: Using Kirchoff's laws, obtain the potential difference across AB in the given figure.

Solution :

In the figure by using KCL; current in the arm DC = 2-1=1A

So Potential difference across AB is ;

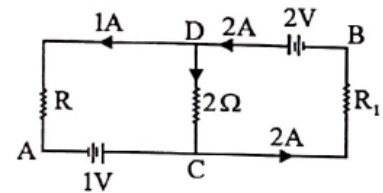

$$V_{AB} = V_{AC} + V_{CD} + V_{DB} = -1\text{V} - 2\Omega \times 1\text{A} + 2\text{V} = -1\text{V}$$

Question 56:- Determine the current in each branch of the network shown in the figure.

(NCERT)

Solution :

The current distribution is shown by using KCL.

Using KVL, in the loop ABCA, $4I_2 + 2(I_2 + I_3) + 1(I_1) = 10$

$$\Rightarrow I_1 + 6I_2 + 2I_3 = 10 \quad \text{.....(i)}$$

In the loop ACDA, $1(I_1) - 2(I_2 + I_3 - I_1) + 4(I_1 - I_2) = 10$

$$\Rightarrow 7I_1 - 6I_2 - 2I_3 = 10 \quad \text{.....(ii)}$$

In the loop BCDB, $2(I_2 + I_3) + 2(I_2 + I_3 - I_1) = 5 \Rightarrow -2I_1 + 4I_2 + 4I_3 = 5 \quad \text{.....(iii)}$

Now adding equations (i) and (ii) we get, $8I_1 = 20 \Rightarrow I_1 = \frac{20}{8} \text{ A} = \frac{5}{2} \text{ A} \quad \text{.....(iv)}$

Now equation (i) x 2 $\Rightarrow 2I_1 + 12I_2 + 4I_3 = 20$ equation (iii) $\Rightarrow -2I_1 + 4I_2 + 4I_3 = 5$

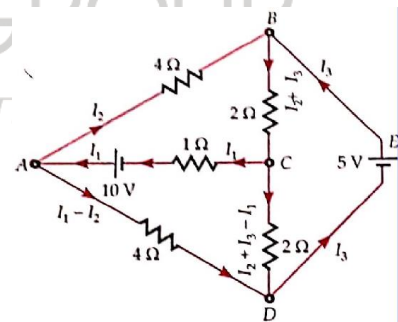

Subtracting the two we have ; $4I_1 + 8I_2 = 15 \Rightarrow 4 \times \frac{5}{2} + 8I_2 = 15 \Rightarrow I_2 = \frac{5}{8} \text{ A}$

Using values of I_1 and I_2 in equation (i) we get, $I_3 = \frac{15}{8} \text{ A}$

Now for each arm; $CA = I_1 = 5/2 \text{ A}$; $AB = I_2 = 5/8 \text{ A}$; $DEB = I_3 = 15/8 \text{ A}$

$AD = I_1 - I_2 = 5/2 - 5/8 = 15/8 \text{ A}$; $BC = I_2 + I_3 = 5/8 + 15/8 = 5/2 \text{ A}$; $CD = I_2 + I_3 - I_1 = 0$

Question 57: The four arms of a Wheatstone bridge have the following resistances:

$AB = 100\Omega$, $BC = 10\Omega$, $CD = 5\Omega$, and $DA = 60\Omega$. A galvanometer of 15Ω resistances is connected across BD . Calculate the current through the galvanometer when a potential difference of 10V is maintained across AC . (NCERT)

Solution: Current distribution is shown by using KCL.

Using KVL, in the loop ABDA, $100I_1 - 60(I - I_1) + 15(I_g) = 0$

$$\Rightarrow -60I + 160I_1 + 15I_g = 0 \quad \dots\dots\dots(i)$$

In the loop BCDB; $10(I_1 - I_g) - 5(I - I_1 + I_g) - 15I_g = 0$

$$\Rightarrow -5I + 15I_1 - 30I_g = 0 \quad \dots\dots(ii)$$

In the loop ABCEA; $100I_1 + 10(I_1 - I_g) = 10$

$$\Rightarrow 110I_1 - 10I_g = 10 \quad \dots\dots(iii)$$

Subtracting $[12 \times \text{equation(ii)}]$ from equation(i) we have

$$-20I_1 + 375I_g = 0 \Rightarrow I_1 = \frac{375}{20} I_g \quad \dots\dots\dots(iv)$$

Using equation (iv) in equation (iii) we get ; $110 \times \frac{375}{20} I_g - 10I_g = 10 \Rightarrow I_g = 0.00487 \text{ A} = 4.87 \text{ mA}$

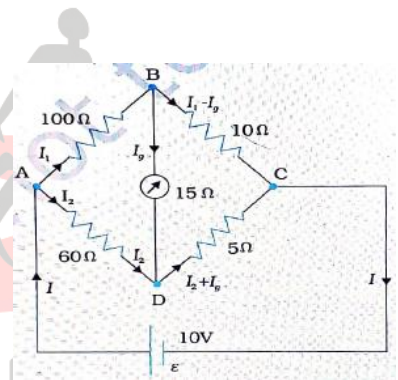

Question 58: Determine the current in each branch of the network shown in the figure. (NCERT)

Solution :

Current distribution is shown by using KCL and symmetry

Using KVL, in the loop ABDA, $10I_1 + 5(2I_1 - I) - 5(I - I_1) = 0 \Rightarrow -2I + 5I_1 = 0 \Rightarrow I_1 = \frac{2I}{5}$ (i)

in the loop ABDA, $5(I - I_1) + 10I_1 + 10I = 10 \Rightarrow 15I_1 + 5I = 10 \Rightarrow 3I_1 + I = 2$ (ii)

Using equation (i) in (ii) we have, $I = \frac{10}{17} \text{ A}$ and $I_1 = \frac{4}{17} \text{ A}$

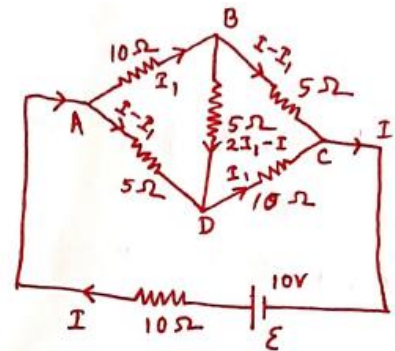

Now, Along AB $I_1 = \frac{4}{17} \text{ A}$; AD $I - I_1 = \frac{6}{17} \text{ A}$;

BC $I - I_1 = \frac{6}{17} \text{ A}$, DC $I_1 = \frac{4}{17} \text{ A}$, BD $2I_1 - I = -\frac{2}{17} \text{ A}$

i.e. $\frac{2}{17} \text{ A}$ from D to B ; CEA $I = \frac{10}{17} \text{ A}$

Question 59: A battery of 10 V and negligible internal resistance is connected across the diagonally opposite corners of a cubical network consisting of 12 resistors each of resistance 1 Ω . Determine the equivalent resistance of the network and the current along each edge of the cube.

Solution :

The current is distributed using symmetry and KCL.

Using KVL in the loop ABCC'EA; $1.I + 1.I/2 + 1.I = 10$

$\Rightarrow I = 4 \text{ A}$

Total current entering into the network = $3I = 12 \text{ A}$

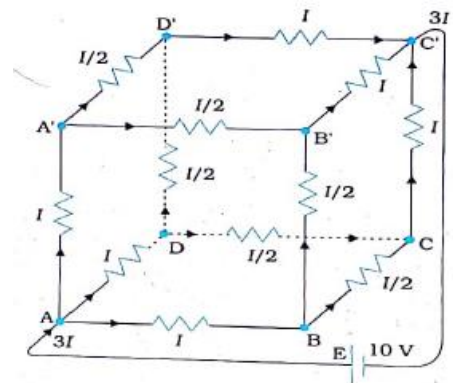

$$\therefore R_{\text{eq}} = \frac{V}{3I} = \frac{10V}{12A} = \frac{5}{6} \Omega$$

Now currents along arms AB, AD, AA', D'C', BC', CC'=4A

Currents through arms; DC, DD', BC, BB', A'B', A'D'=I/2=2A

Meter bridge :

The Meter Bridge is a practical wheat stone bridge. It is named so because it contains a 1-meter long wire AC fixed at both ends.

This is used to measure an unknown resistance X.

X is connected across C and D in the circuit. A known resistance R is connected across A and D. Cell is connected across A and C i.e. across the wire. A galvanometer is connected across from D and a jockey J is attached to the other end. J is moved on the wire till the galvanometer shows no deflection. At this stage, J is at a point B on the wire. Now the meter bridge is a balanced wheat stone bridge.

Principle: Meter bridge works upon the principle of a balanced Wheat stone bridge.

i.e. when a wheat stone bridge is balanced there is no current through the galvanometer and

$$\frac{P}{Q} = \frac{R}{X}$$

Changing your Tomorrow

Determination of unknown resistance:

Here P = resistance of the part AB of the length l of the wire

$$\Rightarrow P = \frac{\rho l}{A}$$

Similarly Q = Resistance of the part BC of the wire of length (100 cm - l)

$$\Rightarrow Q = \frac{\rho(100\text{cm}-l)}{A}$$

Where ρ = resistivity of the material of the wire AC, and A = area of cross-section of the wire.

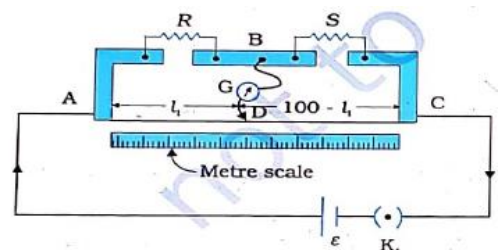

At the balanced condition of the bridge,

$$\frac{P}{Q} = \frac{R}{X}$$

$$\Rightarrow \frac{\rho \frac{l}{A}}{\rho \frac{(100\text{cm} - l)}{A}} = \frac{R}{X}$$

$$\Rightarrow \frac{l}{100\text{cm} - l} = \frac{R}{X}$$

$$\Rightarrow X = \frac{(100\text{cm} - l)R}{l}$$

This is the expression for the unknown resistance X.

Question 60 : (a) In the given meter bridge the balance point is found to be at 39.5 cm from the end A when the resistor S is of 12.5 Ω . Determine the resistance of R. Why are the connections between resistors in a Wheatstone or meter bridge made of thick copper strips?

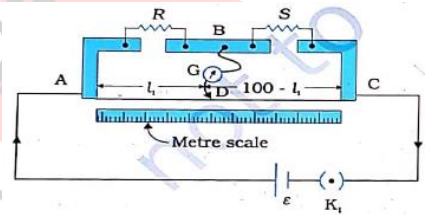

(b) Determine the balance point of the bridge above if R and S are interchanged.

(c) What happens if the galvanometer and cell are interchanged at the balance point of the bridge? Would the galvanometer show any current?

Solution :

$$(a) \text{ As } \frac{R}{S} = \frac{l_1}{100 - l_1} \Rightarrow R = \frac{l_1}{100 - l_1} S = \frac{39.5}{60.5} \times 12.5 \Omega = 8.16 \Omega$$

As resistance $R \propto \frac{l}{A}$ Hence thick copper strips has negligible resistance. So they are used for connections.

(b) If R and S are interchanged then let balancing length becomes l .

$$\therefore \frac{S}{R} = \frac{l}{100-l} \Rightarrow \frac{12.5}{8.16} = \frac{l}{100-l} \Rightarrow l = 60.5\text{cm}$$

(c) If the galvanometer and cell are interchanged there is no effect to balancing condition i.e. current through galvanometer is 0.

Question 61 :(a) In the given meter bridge the balance point is found to be at l_1 from the end A. When a resistance X is connected in parallel with S the balance point is found to be at l_2 from the end A. Obtain an expression for S in term of X, l_1, l_2

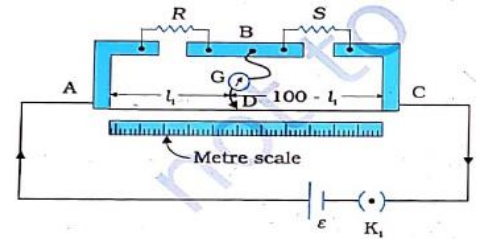

Solution :

For the first case,
$$S = \frac{(100-l_1)R}{l_1} \dots\dots\dots(i)$$

For the second case,
$$\frac{SX}{S+X} = \frac{(100-l_1)R}{l_1} \dots\dots\dots(ii)$$

$$\frac{\text{equation(i)}}{\text{equation(ii)}} \Rightarrow \frac{S+X}{X} = \frac{(100-l_1)l_2}{(100-l_2)l_1}$$

$$\Rightarrow \frac{S}{X} + 1 = \frac{(100-l_1)l_2}{(100-l_2)l_1}$$

$$\Rightarrow \frac{S}{X} = \frac{(100-l_1)l_2}{(100-l_2)l_1} - 1 = \frac{100l_2 - l_2l_1 - 100l_1 + l_2l_1}{(100-l_2)l_1} = \frac{100(l_2-l_1)}{(100-l_2)l_1} \Rightarrow S = \frac{100(l_2-l_1)X}{(100-l_2)l_1}$$

Potentiometer :

The potentiometer is a device used to measure the voltage across an element of a circuit...

Principle: Potential difference across any length of a potentiometer wire is directly proportional to the length l i.e. $V \propto l \Rightarrow V = \phi l$

Where ϕ = potential drop per unit length of potentiometer wire

The expression for potential drop per unit length :

It contains a long wire AB of length (l_0) and uniform cross-section of area A connected across a cell called as driver cell of emf (ξ_0) and a variable resistor of resistance R.

So the resistance of potentiometer wire is

$$R_0 = \rho \frac{l_0}{A} \dots(i)$$



Where ρ = resistivity of potentiometer wire

Current in the driver circuit is

$$I_0 = \frac{\xi_0}{R' + R_0} = \frac{\xi_0}{R' + \frac{\rho l_0}{A}} = \frac{A \xi_0}{AR' + \rho l_0} \dots(ii)$$

The potential difference across potentiometer wire is $V_0 = I_0 R_0$

So potential drop per unit length is $\phi = \frac{V_0}{l_0} = \frac{I_0 R_0}{l_0} = \frac{I_0 \rho}{A}$ (Using equation (i)) ... (iii)

Method to measure voltage: The element of a second circuit, whose voltage is to be measured is connected across C and D. The jockey is moved on the potentiometer wire till the galvanometer shows no deflection. At this null point condition, no current is drawn by potentiometer wire from the element and vice versa.

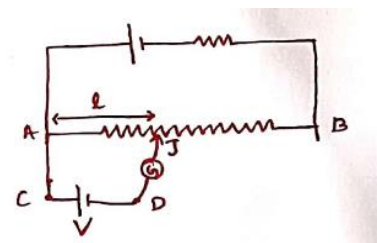

$$\text{So } V_A = V_C \quad \text{and } V_J = V_B$$

$$\text{So the voltage of the element is } V = V_C - V_D$$

$$\Rightarrow V = V_A - V_J = I_0 R_{AJ} = I_0 \frac{\rho l}{A} = \phi l$$

$$\text{Where } \phi = \text{potential drop per unit length of potentiometer wire} = \frac{I_0 \rho}{A}$$

l = null point length i.e. AJ

Sensitivity: It is a measure of how small voltage be measured by the potentiometer . For this ϕ should be very small.

$$\text{As } \phi = \frac{I_0 \rho}{A} = \frac{A \xi_0}{AR + \rho l_0} \frac{\rho}{A} = \frac{\rho \xi_0}{AR + \rho l_0} \quad (\text{Using equation (ii)}) .$$

So potentiometer will be more sensitive or ϕ should be very small if

(i) the resistance of the driver circuit is very high

(ii) length of potentiometer wire should be very large

(iii) the wire should be thick.

The advantage of the potentiometer in comparison to a voltmeter is that potentiometer doesn't draw any current from the element where the voltmeter draws. So potentiometer measures the exact voltage of the element where the voltmeter measures smaller voltage.

Question 62: A potentiometer circuit uses a driver cell of emf 2 V with internal resistance 0.5Ω and potentiometer wire of resistance 7.5Ω with a length of 400 cm.

(i) Calculate the potential drop per unit length

(ii) Find balancing length for a cell of emf 1 V.

Solution :

$$(i) \quad I_0 = \frac{\xi_0}{r + R_0} = \frac{2V}{0.5\Omega + 7.5\Omega} = \frac{1}{4} A$$

$$\therefore \phi = \frac{V_0}{l_0} = \frac{I_0 R_0}{l_0} = \frac{0.25 \times 7.5}{4} \text{ V/m} = 0.47 \text{ Vm}^{-1}$$

$$(ii) \ l = \frac{V}{\phi} = \frac{1\text{V}}{0.47 \text{Vm}^{-1}} = 2.13\text{m} = 213\text{cm}$$

Determination of emf of a cell OR Comparison of EMFs of two cells:

When a cell of emf ξ_1 is connected across C and D of the potentiometer then the null point is obtained at a distance l_1 .

$$\therefore \xi_1 = \phi l_1 \quad \dots\dots(i)$$

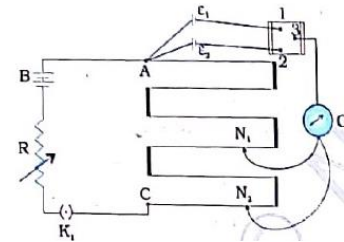

When a cell of emf ξ_2 is connected across C and D of the potentiometer then the null point is obtained at a distance l_2 .

$$\therefore \xi_2 = \phi l_2 \quad \dots\dots(ii)$$

Dividing equation (i) by equation (ii) we get $\frac{\xi_1}{\xi_2} = \frac{\phi l_1}{\phi l_2} = \frac{l_1}{l_2} \dots\dots\dots(iii)$

Out of the two cells if emf of one cell i.e. ξ_1 is known then $\xi_2 = \frac{l_2}{l_1} \xi_1$

This is the expression for the unknown emf

Question 63: The figure shows a potentiometer with a cell of 2.0 V and internal resistance 0.40 Ω maintaining a potential drop across the resistor wire AB. A standard cell which maintains a constant emf of 1.02 V (for very moderate currents up to a few mA) gives a balance point at 67.3 cm length of the wire. To ensure very low currents drawn from the standard cell, very high resistance of 600 k Ω is put in series with it, which is shorted close to the balance point. The standard cell is then replaced by a cell of unknown emf ξ and the balance point found similarly, turns out to be at 82.3 cm length of the wire.

- (a) What is the value?
- (b) What purpose does the high resistance of 600 kW have?
- (c) Is the balance point affected by this high resistance?

(d) Would the method work in the above situation if the driver cell of the potentiometer had an emf of 1.0V instead of 2.0V?

(e) Would the circuit work well for determining an extremely small emf, say of the order of a few mV (such as the typical emf of a thermo-couple)? If not, how will you modify the circuit? (NCERT)

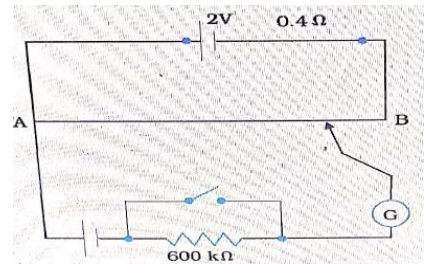

Solution :

(a) Since $\frac{\xi_1}{\xi_2} = \frac{l_1}{l_2} \Rightarrow \xi_2 = \frac{\xi_1 l_2}{l_1} = \frac{1.02 \times 82.3}{67.3} \text{ V} = 1.247 \text{ V}$

(b) The purpose of using high resistance 600kΩ is to protect the galvanometer by ensuring low current to pass through it when the balance point is achieved.

(c) No, the balance point is not affected by the presence of this resistance.

(d) No, the emf of the driver cell must be more than the emf of the cells.

(e) For the measurement of small emf, this circuit will not work well. The length of the potentiometer wire should be increased to have a very small potential drop per unit length. So that the small voltage source can have a considerable balancing length.

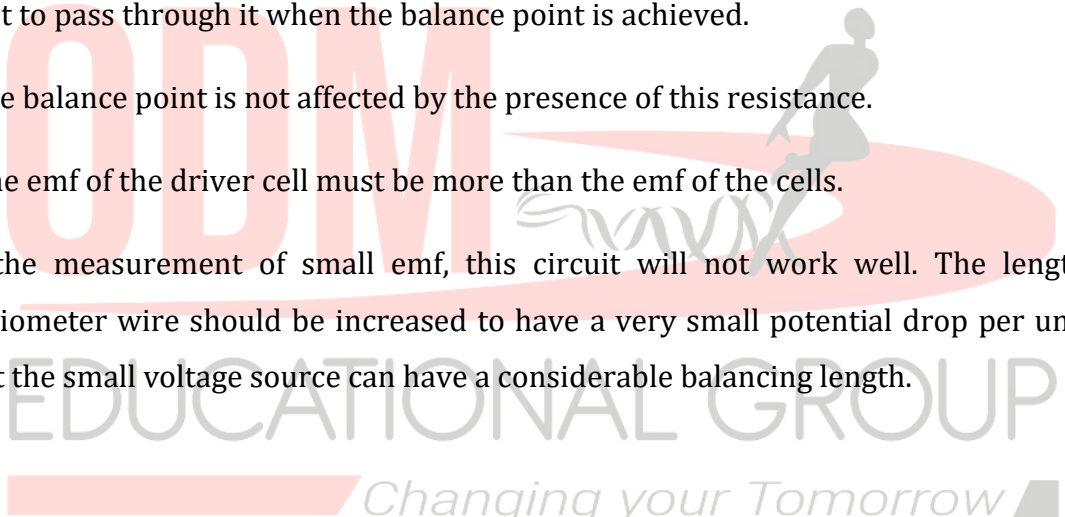

Determination of internal resistance of a cell :

When switch K₂ is open there is no current in the second circuit at the null point position.

If null point length at this condition is l₁ ,

then $\xi = \phi l_1$ (i)

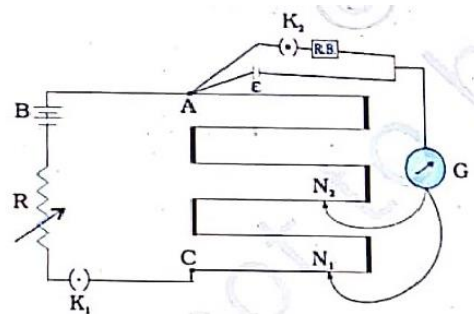

When switch K₂ is closed there is a current I through the second circuit.

So potential difference across the cell is

$V = IR = \xi - Ir$ (ii)

$$\Rightarrow \xi = I(R + r) \quad \dots\dots(iii)$$

Now null point distance is l_2 . So $V = \phi l_2 \quad \dots\dots(iv)$

Dividing equation(i) by equation (iv) we get $\frac{\xi}{V} = \frac{\phi l_1}{\phi l_2} = \frac{l_1}{l_2}$

Now using equations (ii) and (iii) $\Rightarrow \frac{I(R + r)}{IR} = \frac{l_1}{l_2}$

$$\Rightarrow \frac{R + r}{R} = \frac{l_1}{l_2} \Rightarrow R + r = \frac{l_1}{l_2} R \Rightarrow r = \frac{l_1}{l_2} R - R = R \left(\frac{l_1}{l_2} - 1 \right)$$

r is the internal resistance of the cell

and R is the resistance connected across the cell.

Question64: In the given potentiometer circuit length of potentiometer wire AB is 1m and its resistance is 10Ω .

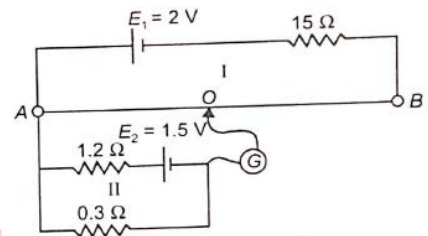

Calculate

- (i) the potential gradient along with AB
- (ii) Length AO of the wire when the galvanometer shows no deflection.

Solution :

(i) In the potentiometer circuit current, $I_0 = \frac{2V}{10\Omega + 15\Omega} = \frac{2}{25} A$

Voltage drop per unit length along potentiometer wire

$$\phi = \frac{I_0 R_0}{l_0} = \frac{2}{25} A \times \frac{10\Omega}{1m} = \frac{4}{5} Vm^{-1} = 0.8Vm^{-1}$$

(ii) In the circuit II current is, $I = \frac{1.5V}{1.2\Omega + 0.3\Omega} = \frac{1.5V}{1.5\Omega} = 1A$

$$\Rightarrow V = 1.5V - (1A \times 1.2\Omega) = 0.3V$$

So balancing length, $l = \frac{V}{\phi} = \frac{0.3}{0.8} m = 37.5cm$

Question65: The figure shows a long potentiometer wire AB with a constant potential gradient. The null points for the two primary cells of EMFs E_1 and E_2 ($E_1 > E_2$) connected in the manners shown are obtained at distances 250 cm and 400cm from A respectively. Calculate (i) $\frac{E_1}{E_2}$ (ii) position of a null point E_1 is connected only

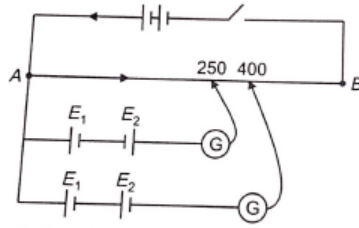

Solution :

From the figure, $E_1 - E_2 = 250\text{cm} \times \phi$ (i)

$E_1 + E_2 = 400\text{cm} \times \phi$ (ii)

Adding equations (i) and (ii) we have , $2E_1 = 650\text{cm} \times \phi$

$\Rightarrow E_1 = 325\text{cm} \times \phi$ (iii)

Using equation (iii) in (ii) we have

$E_2 = 400\text{cm} \times \phi - 325\text{cm} \times \phi = 75\text{cm} \times \phi$ (iv)

(i)
$$\frac{E_1}{E_2} = \frac{325\text{cm} \times \phi}{75\text{cm} \times \phi} = \frac{13}{5}$$

(ii) From equation (iii) we have the null point length of E_1 alone is 325 cm .

Question 66: A resistance R draws current from a potentiometer of resistance R_0 as shown. Derive an expression for the voltage across R when the sliding contact is in the middle of the potentiometer wire. (NCERT)

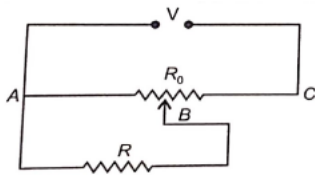

Solution :

From the figure, $R_p = \frac{RR_0/2}{R + R_0/2} = \frac{RR_0}{2R + R_0}$ So, $R_{eq} = R_p + R_0/2$ So, Current, $I = \frac{V}{R_{eq}}$

Now voltage across BC, $V_{BC} = IR_0/2 = \frac{VR_0}{2R_{eq}} = \frac{VR_0}{2(R_p + R_0/2)} = \frac{VR_0}{2R_p + R_0}$

Now voltage across R, $V_{AB} = V - V_{BC} = V - \frac{VR_0}{2R_p + R_0} = \frac{2VR_p}{2R_p + R_0}$

$$= \frac{2V \left(\frac{RR_0}{2R + R_0} \right)}{2 \left(\frac{RR_0}{2R + R_0} \right) + R_0} = \frac{2VRR_0}{2RR_0 + 2RR_0 + R_0^2} = \frac{2VR}{4R + R_0}$$