

में और मेरा परिवार...

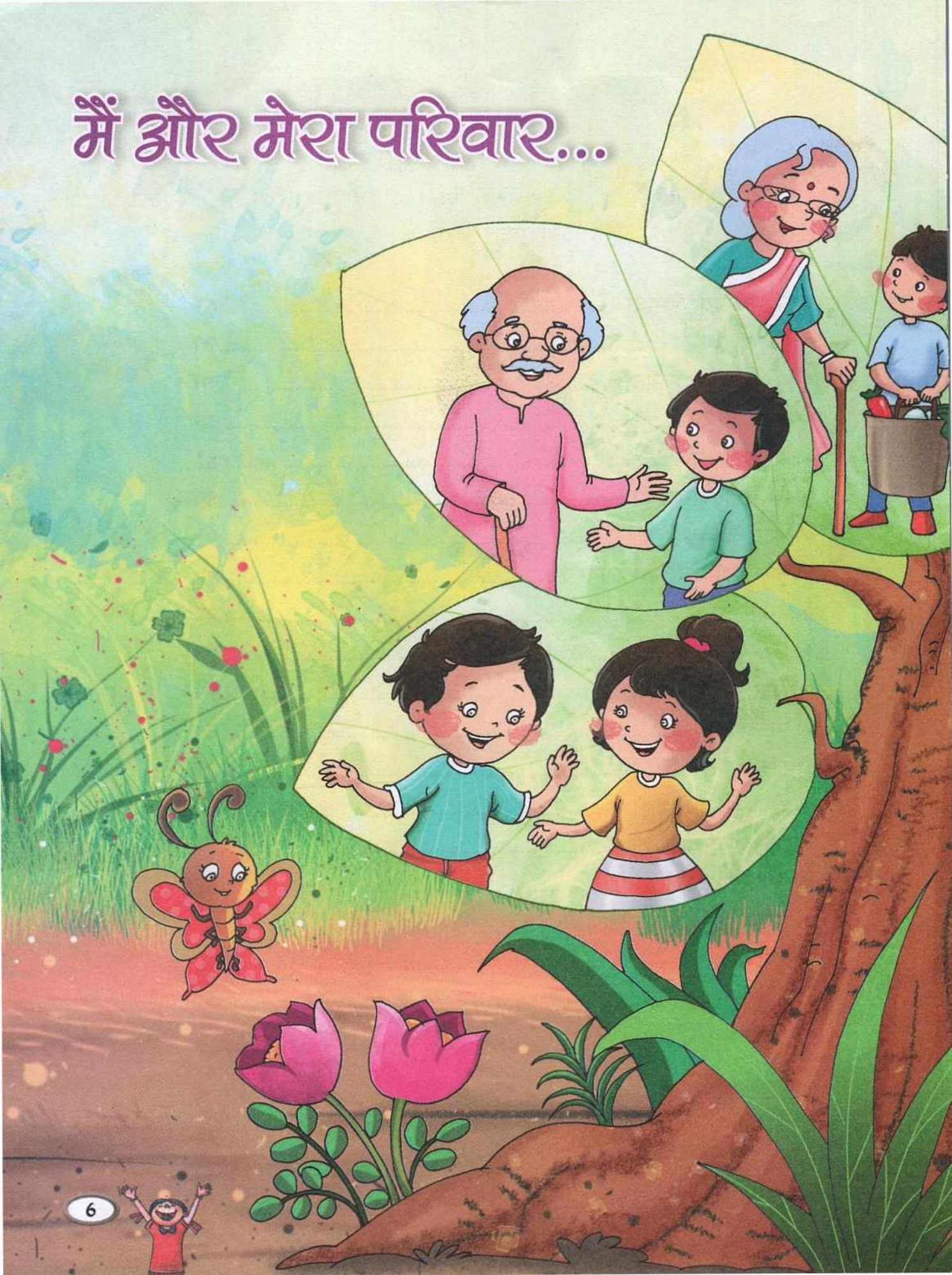

- आपके परिवार में कौन-कौन हैं?
- आप उनकी किन-किन कामों में सहायता करते हैं?
- मेरे चाचा-चाची प्रतिदिन ऑफिस जाते हैं।
- सिद्धार्थ मेरे चाचा-चाची जी का बेटा है। वह मेरे साथ स्कूल जाता है।

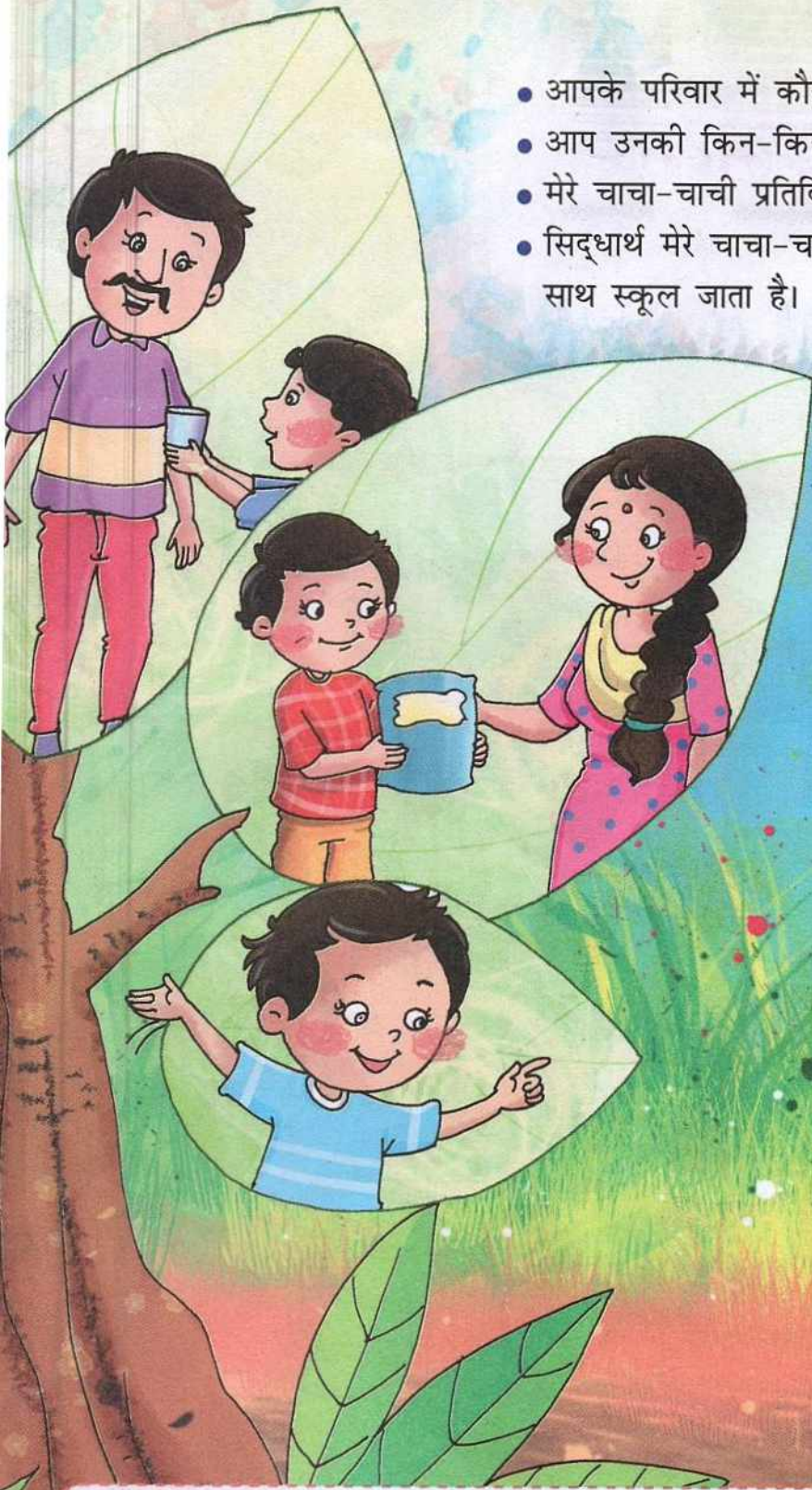

अध्यापन संकेत

- विद्यार्थियों से दृश्य पर बातचीत करें और उनके परिवार के बारे में पूछें। इस दौरान बच्चों की मुखर भागीदारी सुनिश्चित करें।



चलो, चलें स्कूल

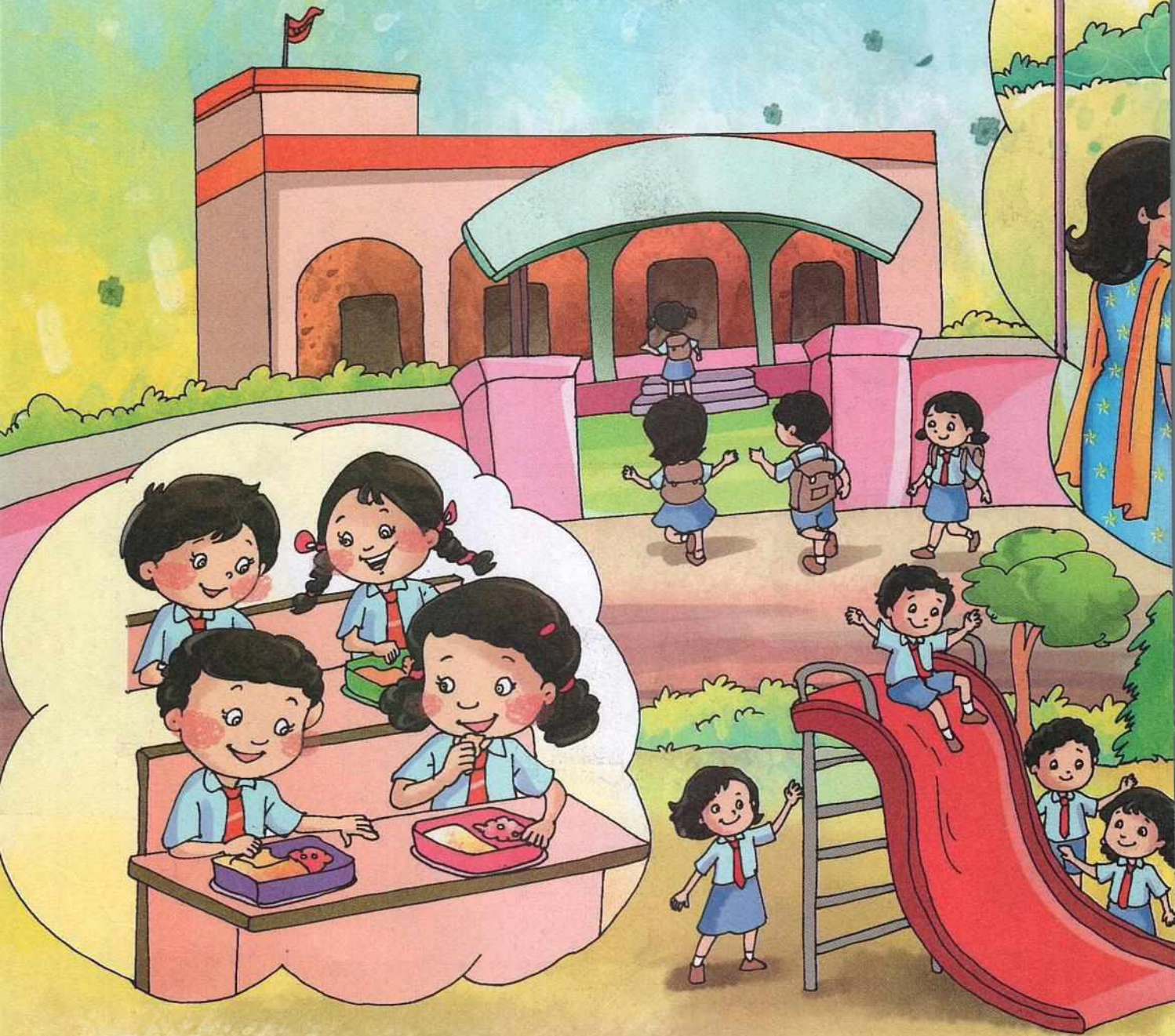

- आपके विद्यालय का नाम क्या है?
- आपको अपने विद्यालय में कौन-सा समय सबसे अच्छा लगता है?



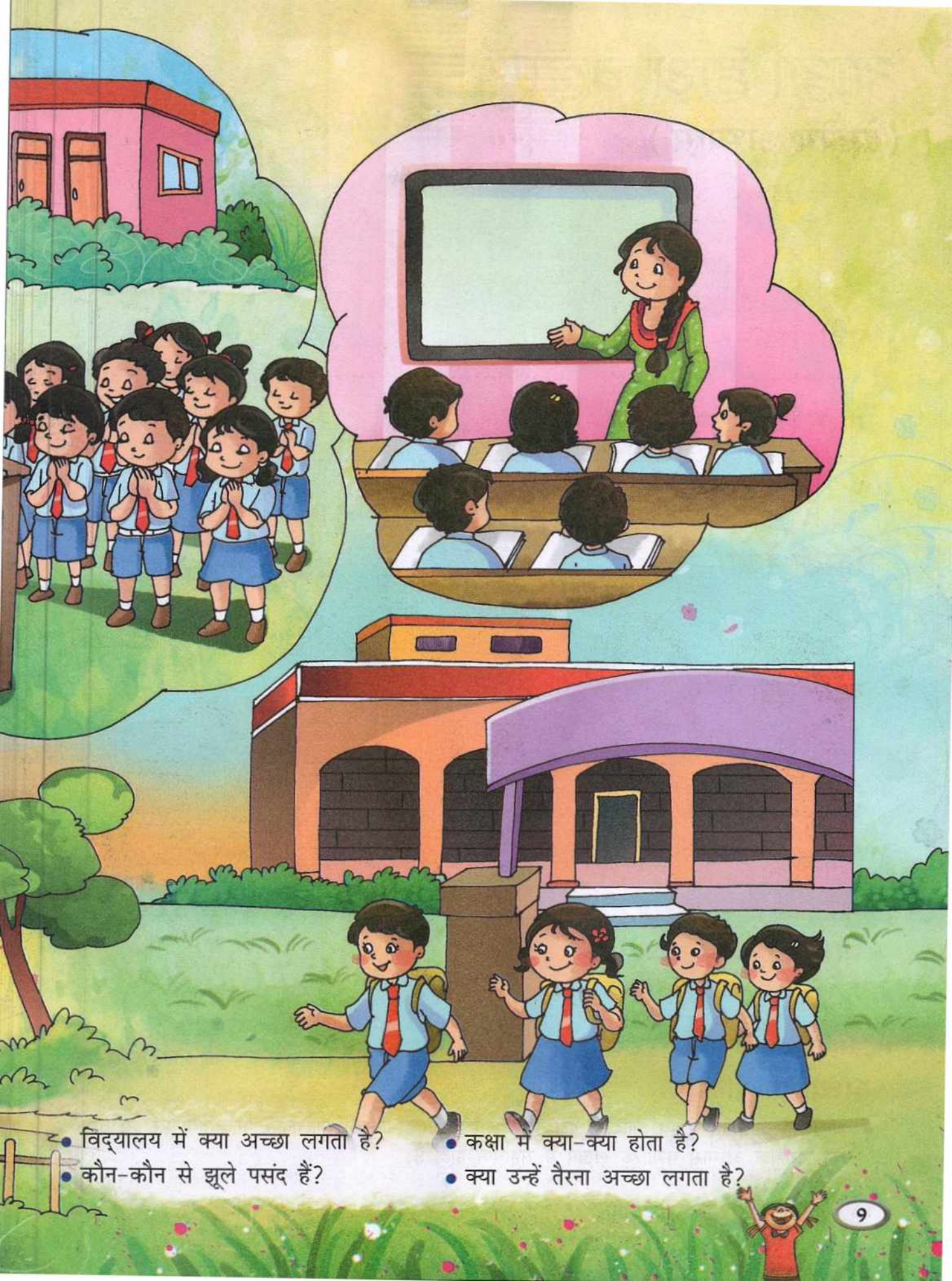

● विद्यालय में क्या अच्छा लगता है?

● कौन-कौन से झूले पसंद हैं?

● कक्षा में क्या-क्या होता है?

● क्या उन्हें तैरना अच्छा लगता है?

आओ हाथ चलाएँ

(रेखीय अभ्यास)

खड़ी रेखा



पड़ी रेखा



पड़ी रेखा खड़ी रेखा



तिरछी रेखा



वक्र रेखा

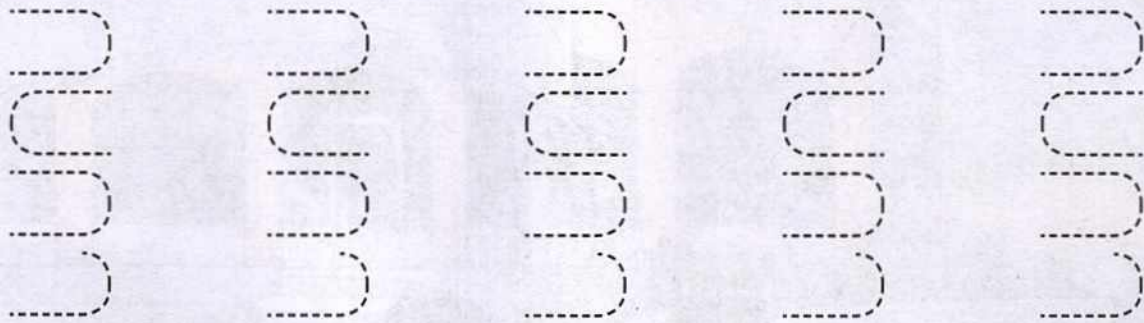

गोलाकार



अध्यापन संकेत

- वर्णों की आकृति, घुमाव आदि में दक्ष होने के लिए आड़ी-तिरछी, गोलाकार आकृतियों पर इस तरह का प्रारंभिक अभ्यास वर्णों के लेखन में सहायक होता है।



क्रेयान से बिंदुओं को जोड़कर रंग भरिए-

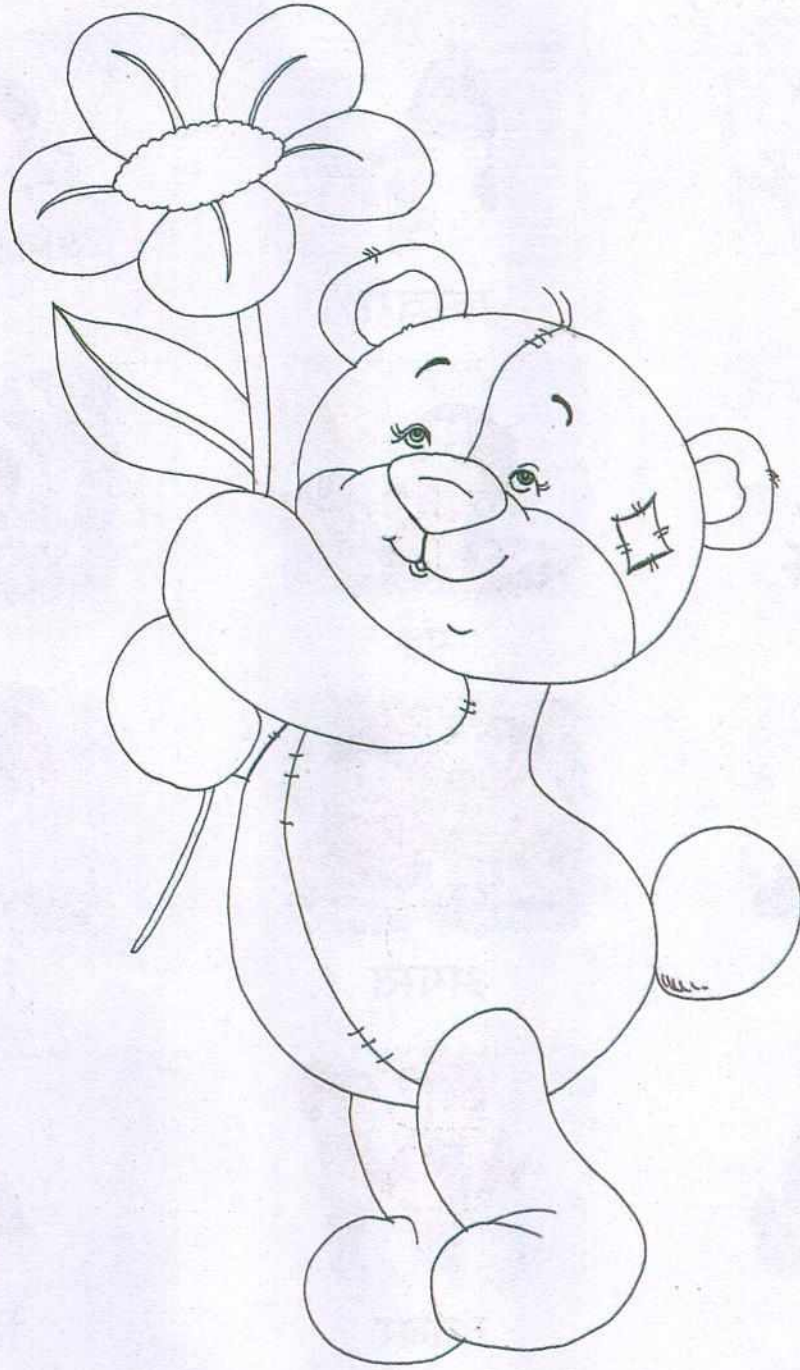

अध्यापन संकेत

- ये आकृतियाँ (पैटर्न) अक्षर लेखन के पूर्वाभ्यास के लिए हैं। इनका अभ्यास करवाएँ।
- बच्चों को अक्षर लेखन में सहजता होगी।



ऋतु और महीने



जनवरी



फ़रवरी



मार्च



अप्रैल



मई



जून



जुलाई



अगस्त



सितंबर



अक्टूबर



नवंबर



दिसंबर

अध्यापन संकेत

अध्यापिका बच्चों से निम्नलिखित प्रश्न पूछें, जैसे-

- आपके परिवार में किसका जन्मदिन किस महीने में मनाया जाता है?
- किन महीनों में सरदी, गरमी और बारिश होती है?



हमारे प्रतीक



राष्ट्रीय ध्वज



अशोक स्तंभ



रुपये का प्रतीक



राष्ट्रीय पशु



राष्ट्रीय पक्षी

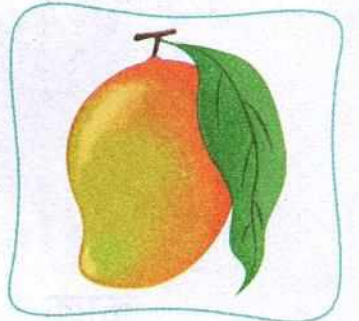

राष्ट्रीय फल



राष्ट्रीय फूल

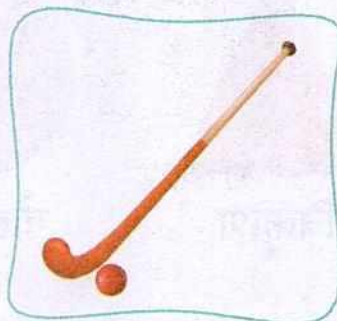

राष्ट्रीय खेल



राष्ट्रपिता



हमें पहचानी

रंग



पीला



हरा



नीला



काला

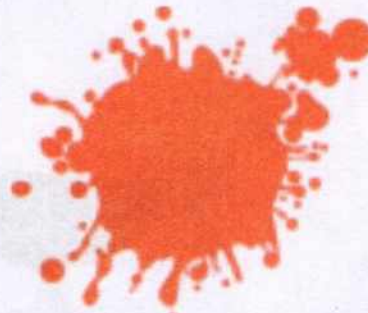

लाल



नारंगी

आकार



चतुर्भुज



त्रिकोण



गोलाकार



अर्धगोलाकार

अध्यापन संकेत

- बच्चों से विभिन्न रंगों तथा आकारों के बारे में बातचीत करें। उन्हें विभिन्न आकार की वस्तुएँ दिखाएँ। विभिन्न रंगों तथा आकारों की पहचान करवाएँ। उनके पसंदीदा रंग तथा आकार के बारे में पूछें।



स्वरमाला



अ



आ



इ



ई



उ

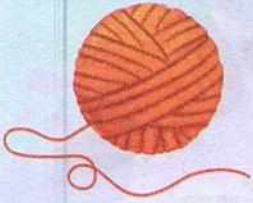

ऊ



ऋ

ॠ

ए



ऐ



ओ



औ



अं



अः



1

आइए, स्वर सीखें



अनार

(*anar*) Pomegranate



अजगर

(*ajgar*) Python

॰	॰	॰	॰	॰	॰
अ	अ	अ	अ	अ	अ
अ	अ	अ	अ	अ	अ
अ	अ	अ	अ	अ	अ



aa
आ

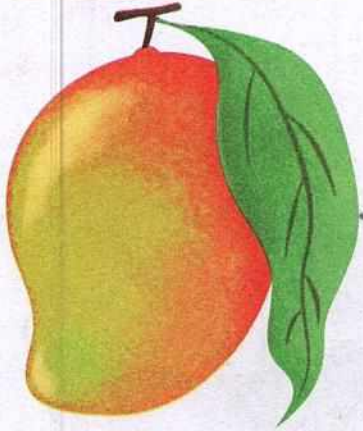
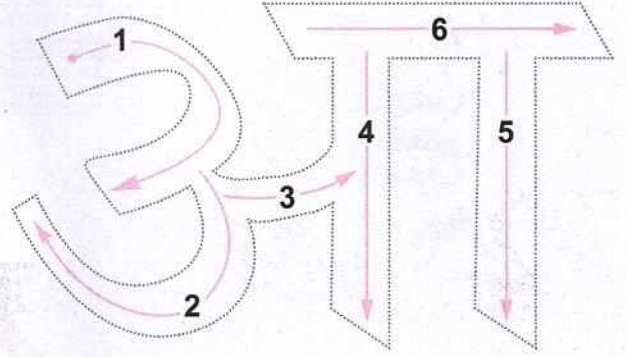

आम
(aam) Mango



आइसक्रीम
(aaeskream) Ice cream

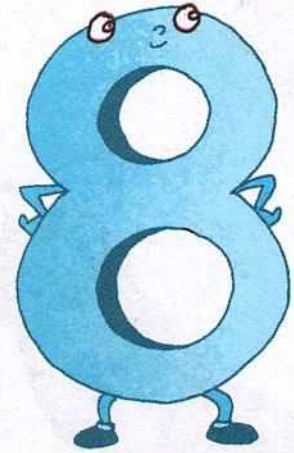

आठ
(aath) Eight

आ आ आ आ आ आ

आ आ आ आ आ आ

आ आ आ आ आ आ

आ आ आ आ आ आ



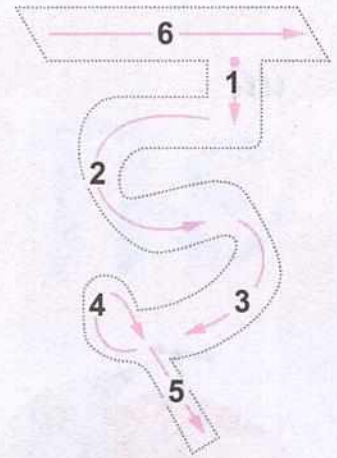
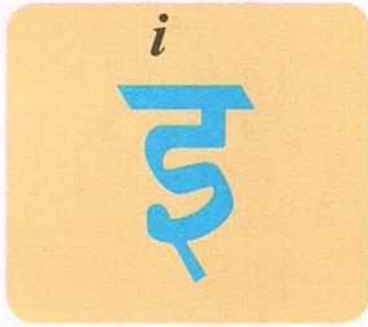

इनाम
(*inam*) Prize

इमली
(*imli*) Tamrind

इडली
(*idli*) Idli

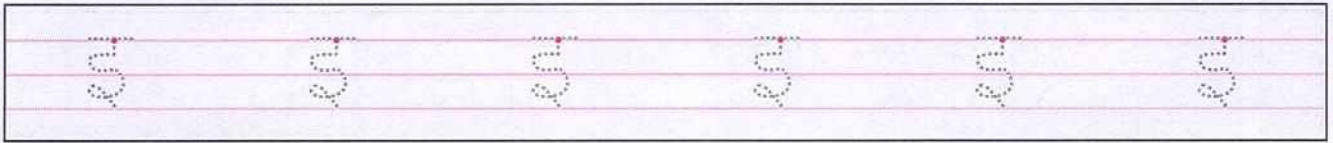
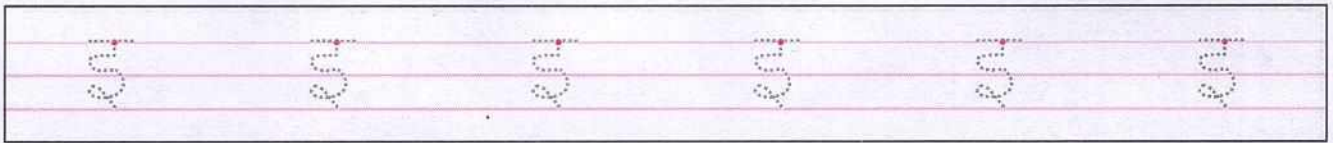
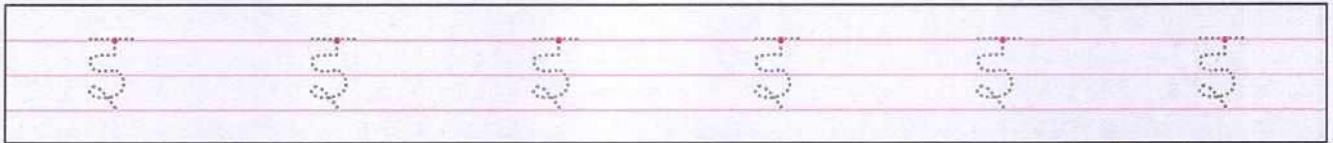
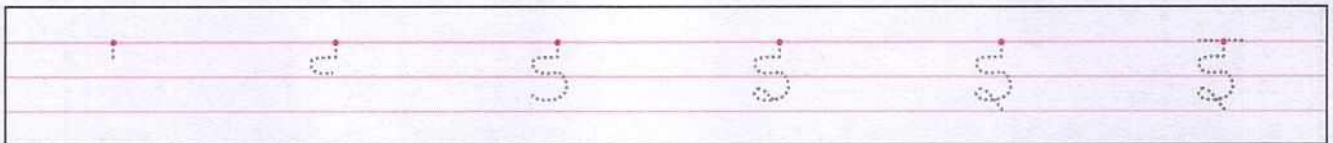

ee

ई



ईद
(eed) Eid



ईख
(eekh) Sugarcane



ईदगाह
(eedgah) Mosque

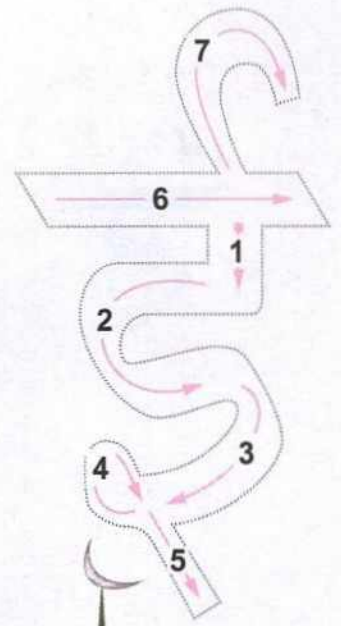

•	•	•	•	•	•
ई	ई	ई	ई	ई	ई
ई	ई	ई	ई	ई	ई
ई	ई	ई	ई	ई	ई



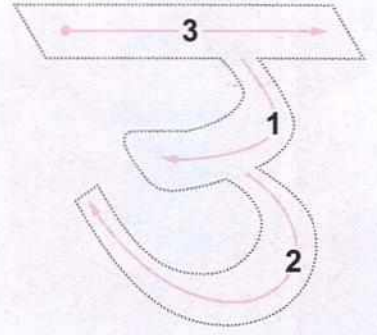

उल्लू
(ulloo) Owl



उपवन
(upvan) Garden



उपहार
(uphaar) Gift

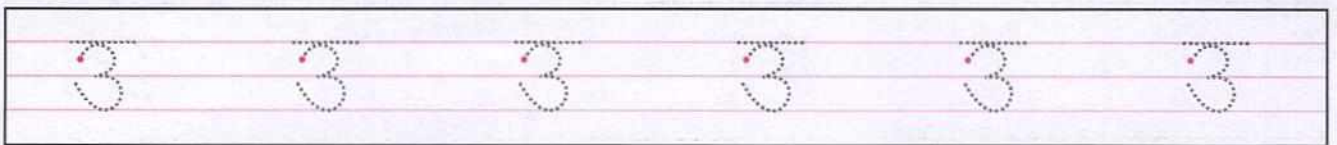
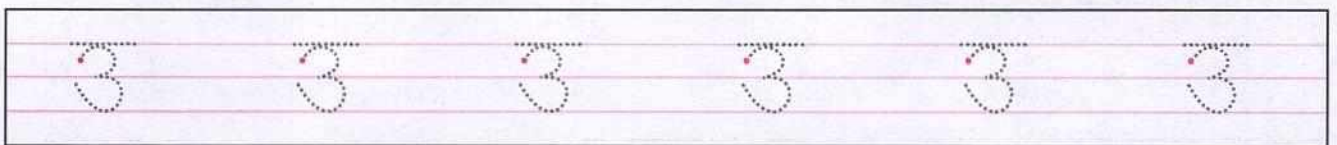
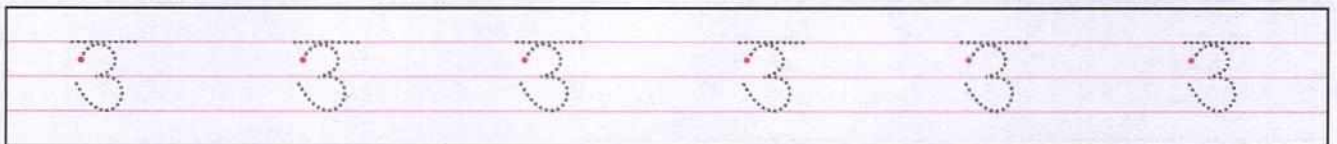
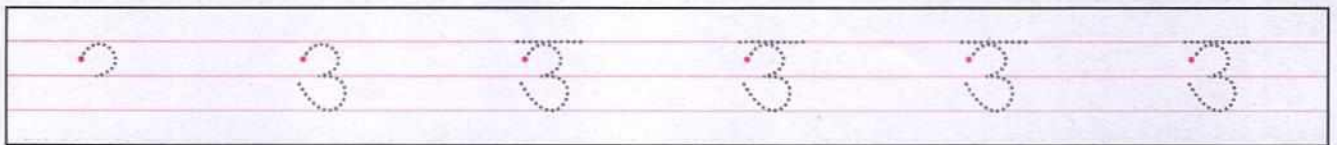

oo

ऊ

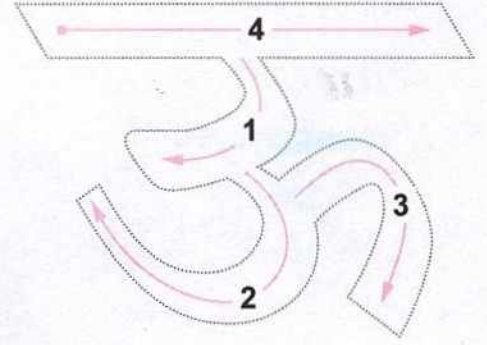

ऊपर
(ooper) Up



ऊन
(oon) Wool



ऊदबिलाव
(oodbilaav) Otter

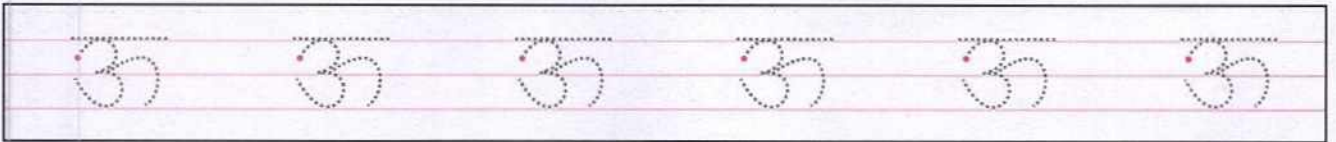
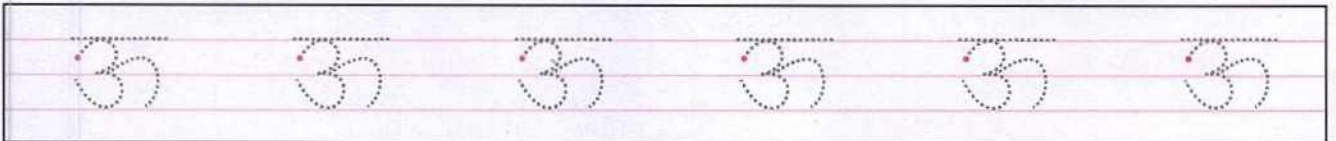
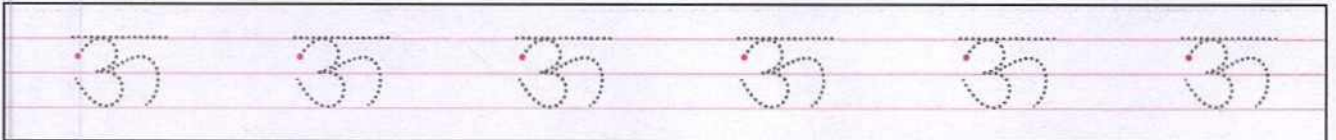
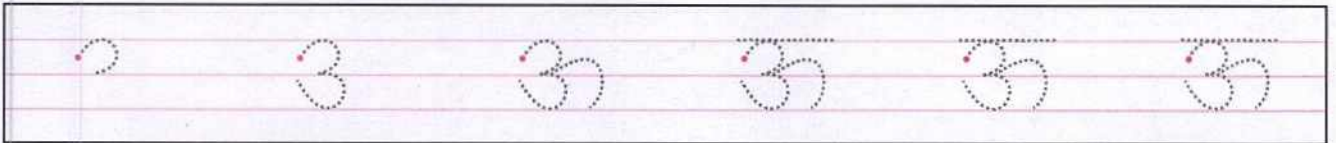

hri

ऋ

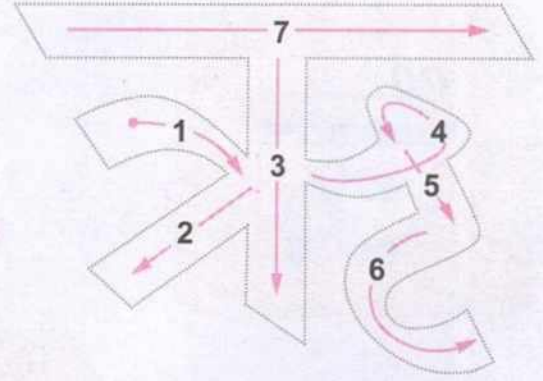

ऋषि
(rishi) Sage



ऋतु
(ritu) Season



ऋषभ
(rishabh) Ox

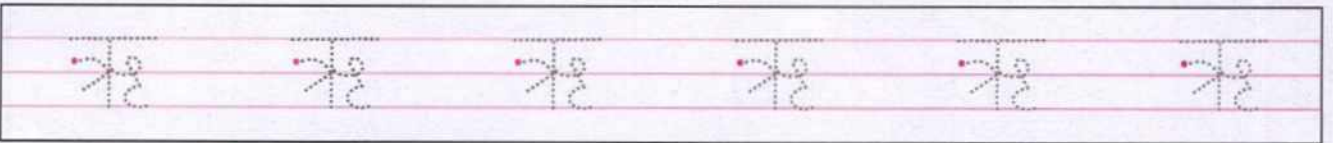
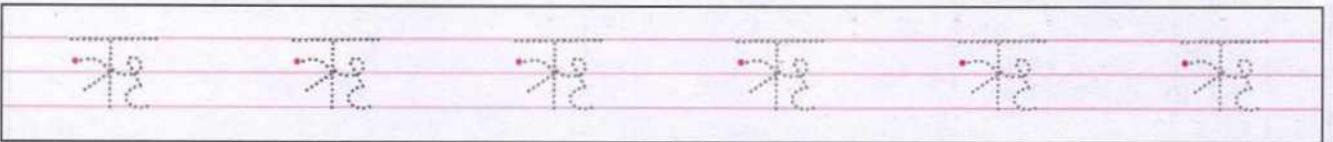
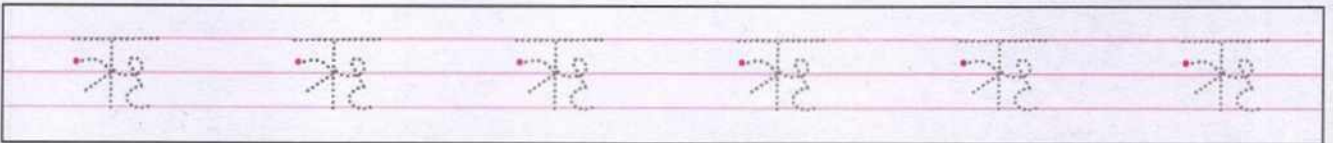
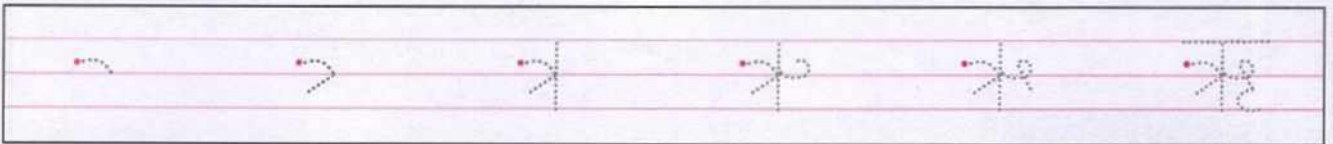



एक
(ek) One

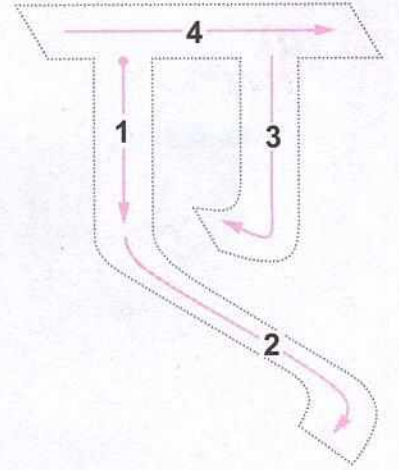

एड़ी
(edee) Heel



एलबम
(elbam) Elbum

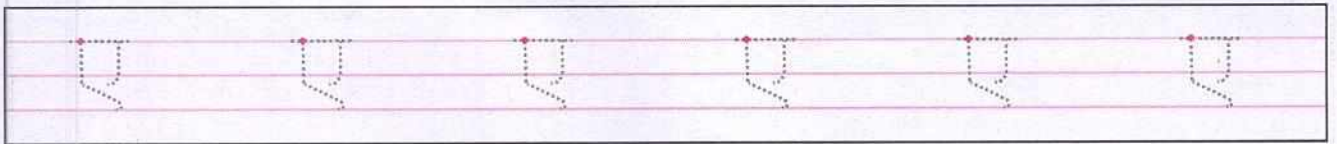
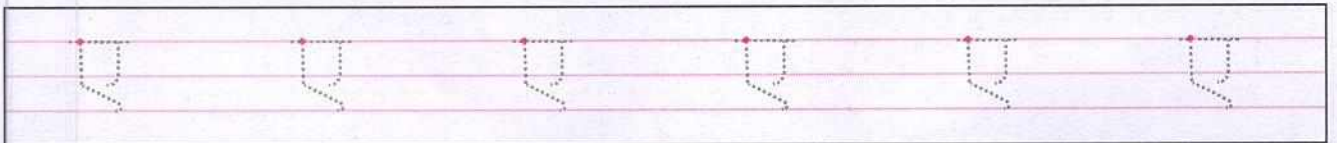
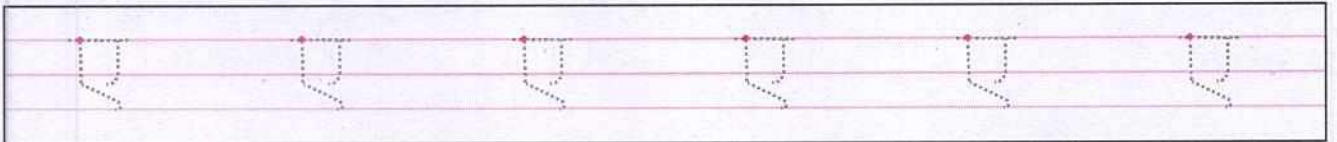
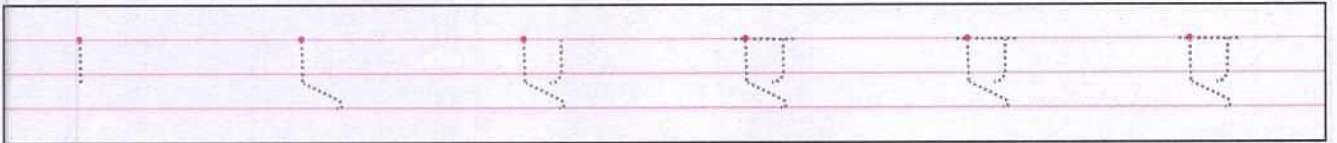

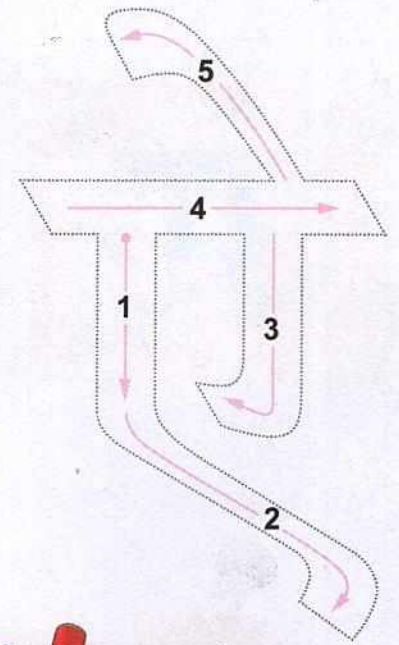
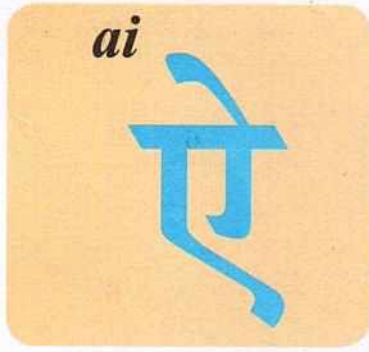

ऐनक
(ainak) Spectacles



ऐरावत
(airavat) Elephant

ऐंबूलेंस
(aimboolens) Ambulance

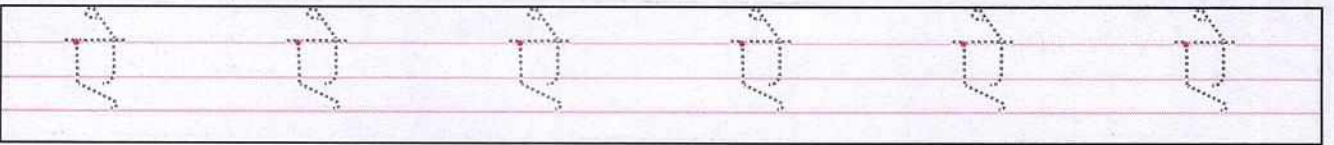
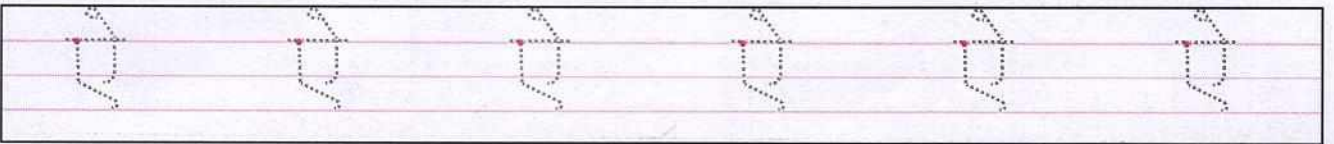
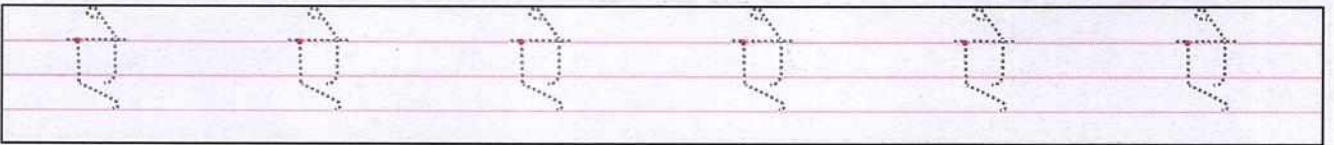
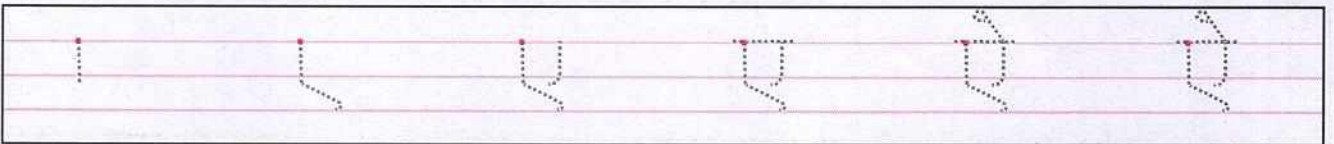

0
ओ



ओखली
(okhalee) Mortar

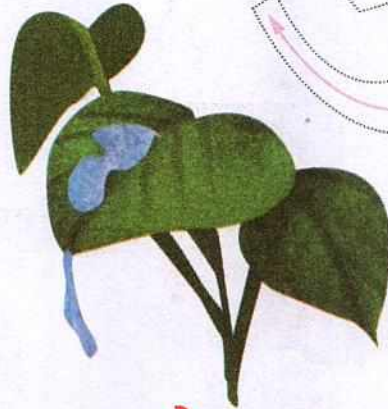

ओस
(os) Dew

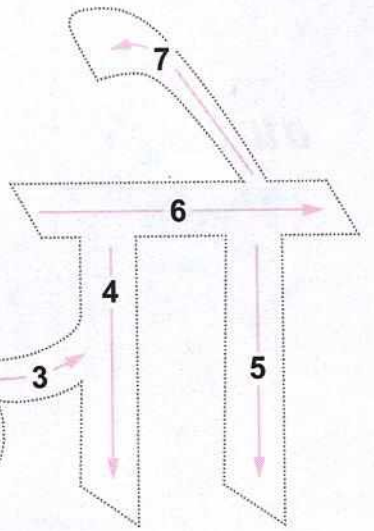
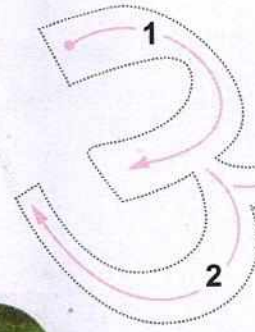

ओठ
(oth) Lips

अ आ आ ओ ओ ओ

ओ ओ ओ ओ ओ ओ

ओ ओ ओ ओ ओ ओ

ओ ओ ओ ओ ओ ओ



au
औ

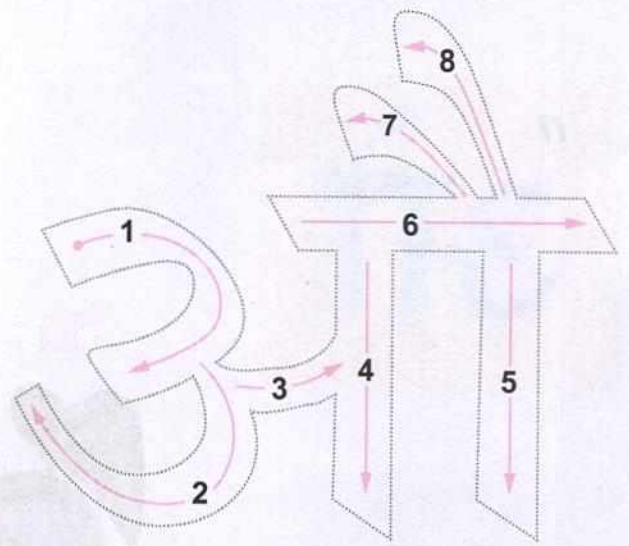

औषधि

(aushadhi) Medicine



औरत

(aurat) Woman

औज़ार

(auzaar) Tools

अ आ आ औ औ औ

औ औ औ औ औ औ

औ औ औ औ औ औ

औ औ औ औ औ औ



an

अं

6

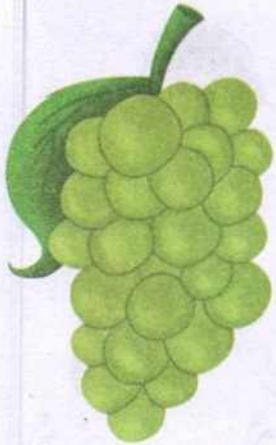
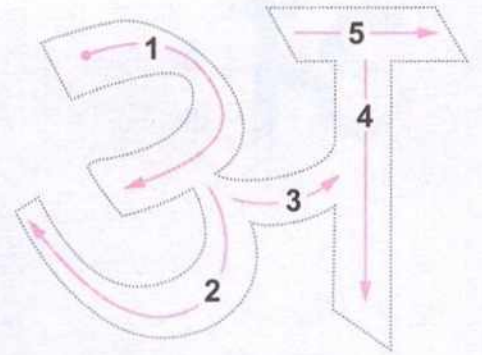

अंगुली
(anguli) Finger



अंक
(ank) Digit

अंगूर
(angoor) Grapes

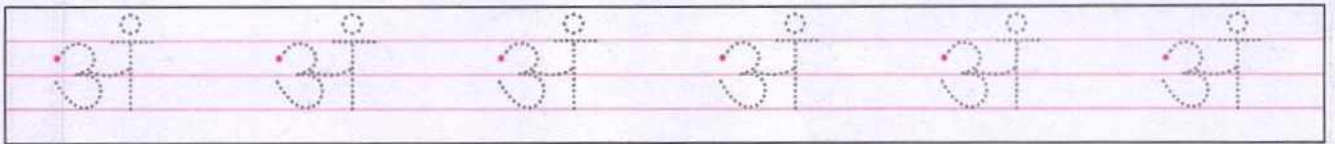
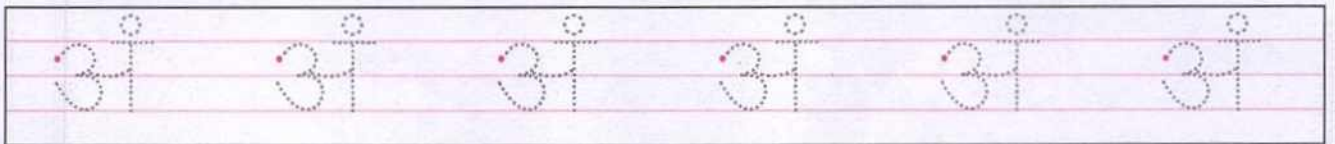
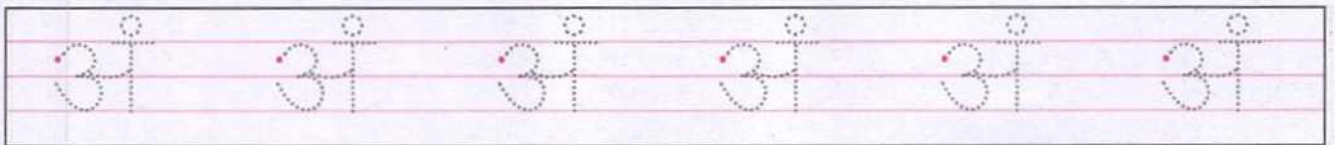
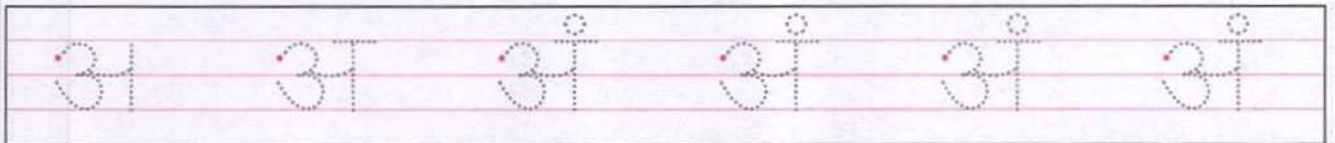

aha

अः

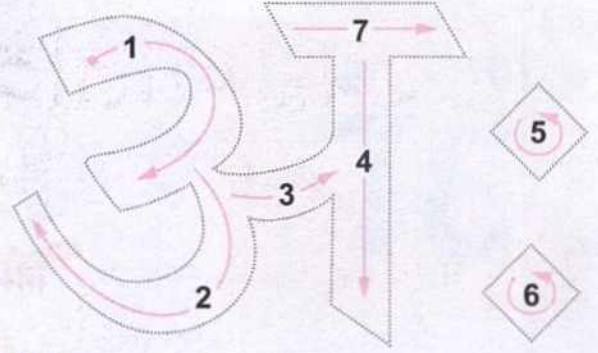

प्रातः

(pratah) Morning

नमः

(namah) Namah

शनैः-शनैः

(shaneh-shaneh)
Slowly-Slowly

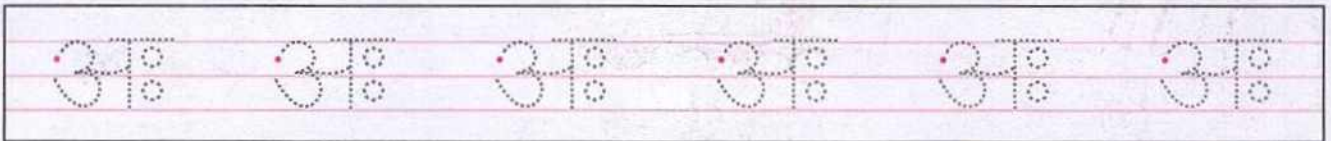
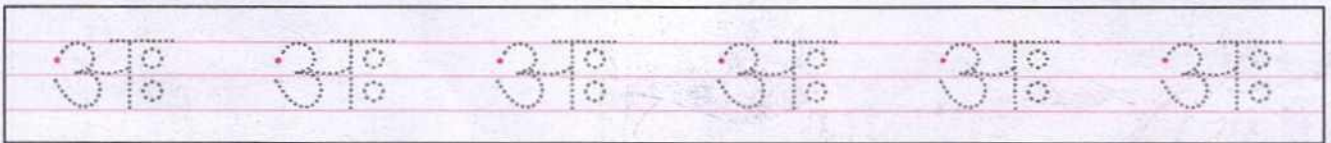
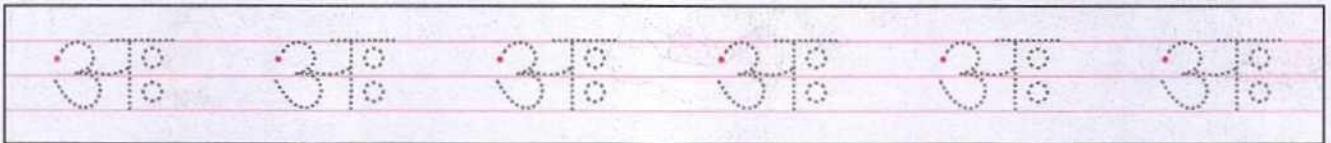
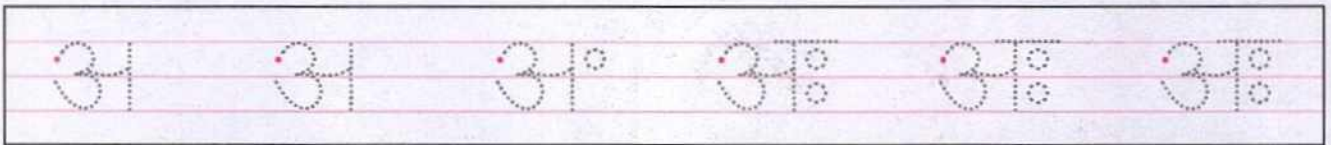

स्वर गतिविधि (अ से अक्ष)

- चित्र पहचानकर उनके नाम का पहला वर्ण बोलिए और लिखिए—

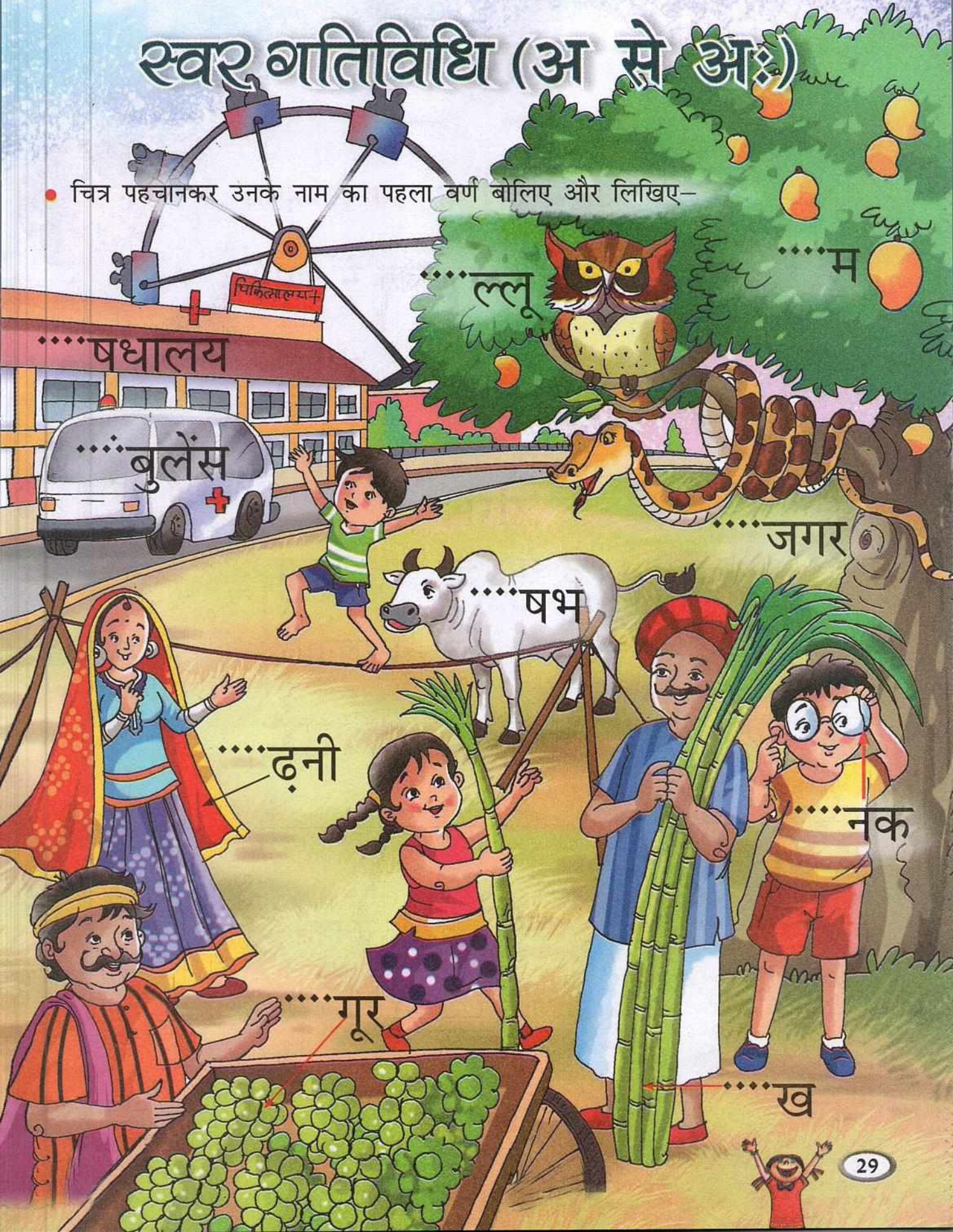

स्वर गीत

अ से अदरक, आ से आम।
बच्चो, करना जग में नाम॥

इ से इमरती, ई से ईख।
हठ मत करना, मानो सीख।

उ से उल्लू, ऊ से ऊन
चलें मसूरी-देहरादून॥

ऋ से ऋषिवर तप में लीन।
मछली को कहते हैं मीन॥

ए से एड़ी, ऐ ऐनक।
बगुले को कहते हैं वक॥

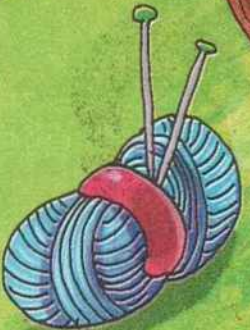
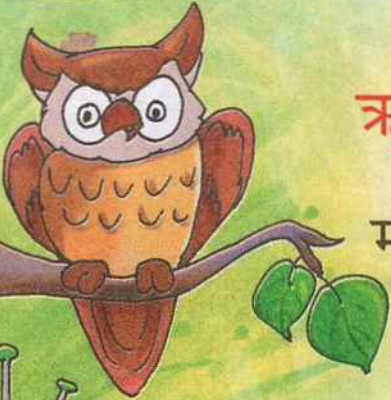
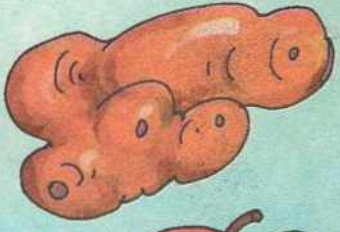
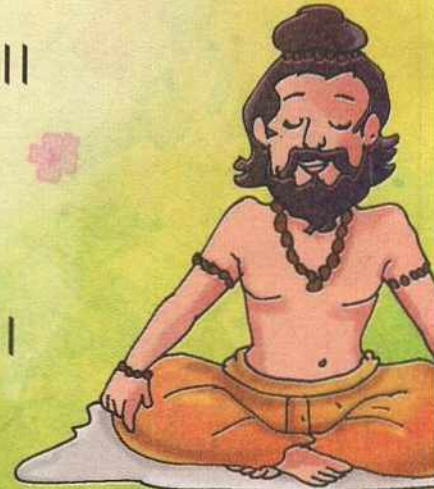

ओ से ओले, औ औरत।
कहते हैं जी सौ को शत॥

अं अंगारा, अः खाली।

बच्चो, बजाओ मिलकर ताली॥

अ आ इ ई उ ऊ ऋ।

मज़े-मज़े में सीखो जी॥

ए ऐ ओ औ अं अः।

दुहराओ यह पुनः पुनः॥

—डॉ० विनोद 'प्रसून'



2

आइए, व्यंजन सीखें

क-वर्ग

ka

क

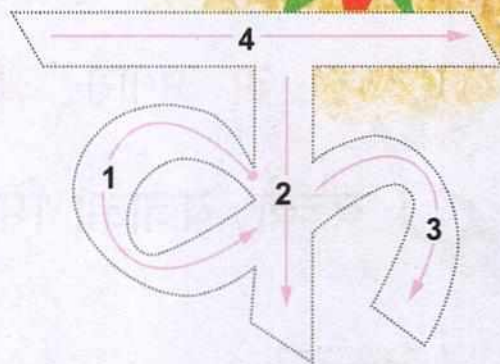

कमल

(kamal) Lotus



कछुआ

(kachhua) Tortoise

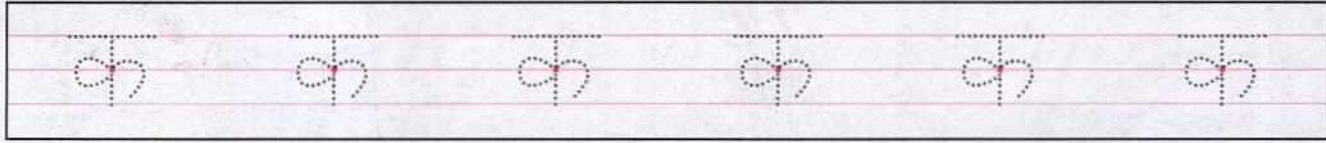
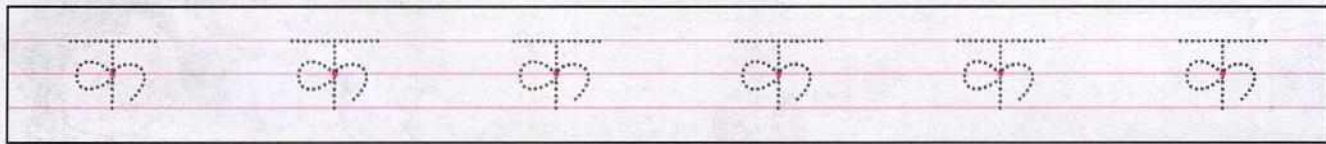
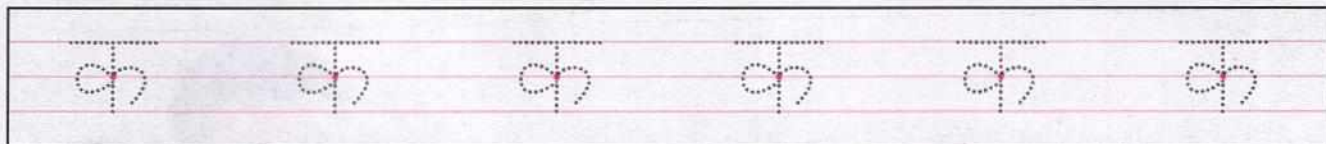
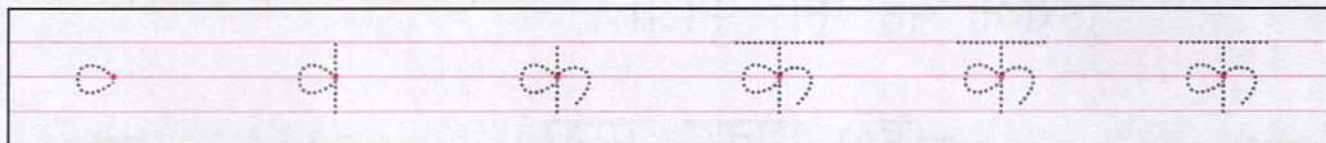

kha

ख

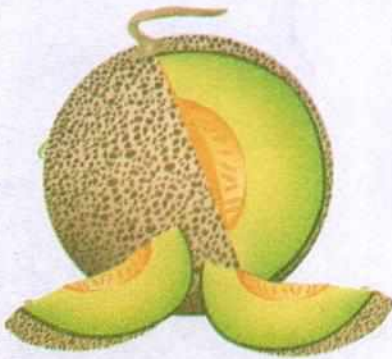
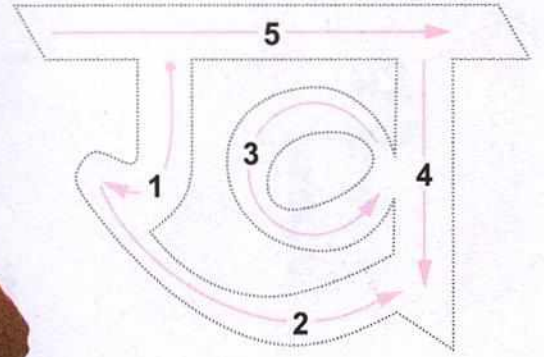

खजूर
(khajoor) Date



खरबूजा
(kharbooja) Muskmelon

खरगोश
(khargosh) Rabbit

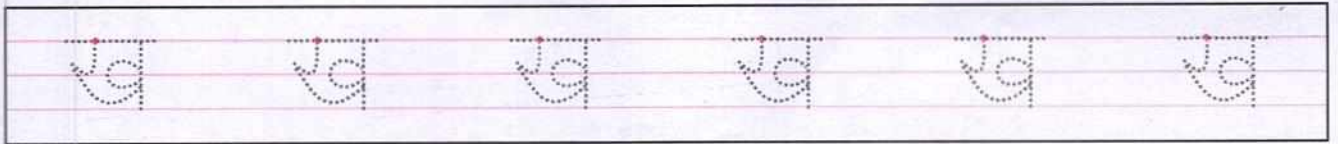
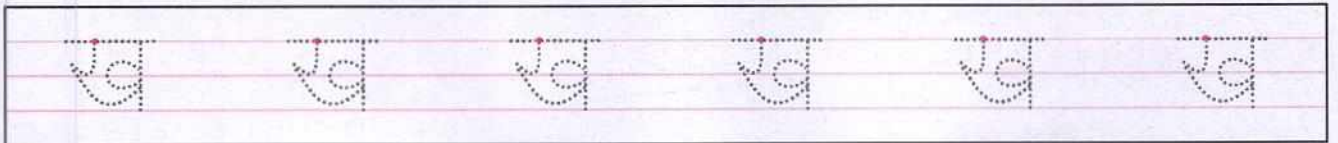
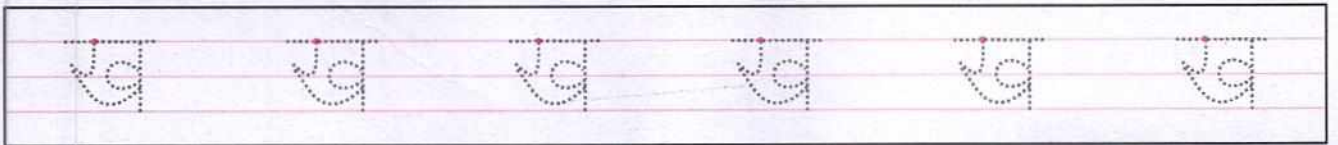
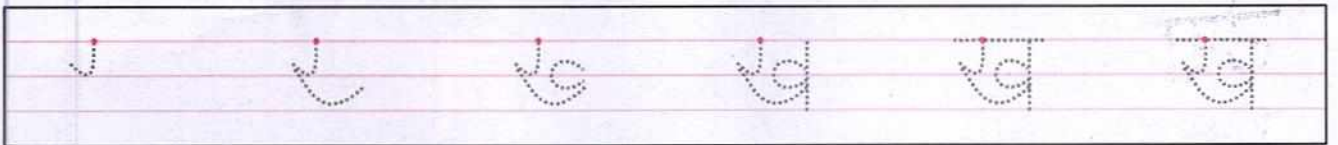

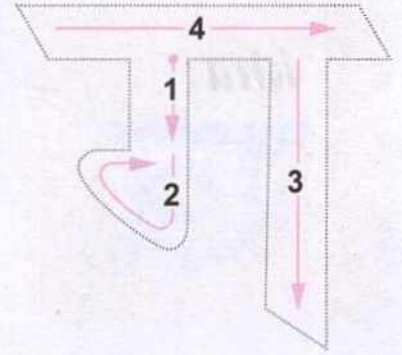
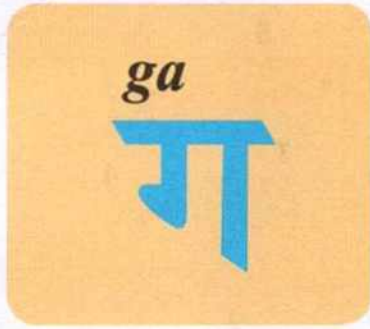

गदा
(gadaa) Mace



गमला
(gamlaa) Flower pot

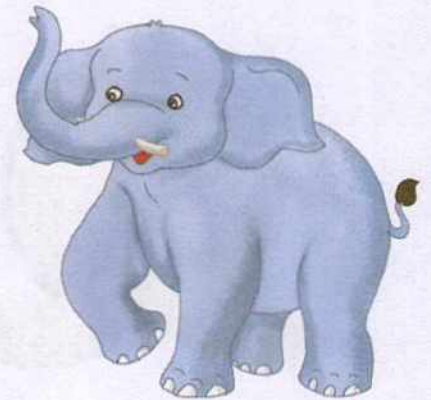

गज
(gaj) Elephant

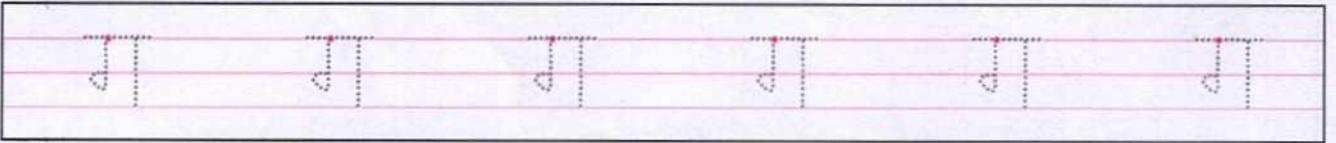
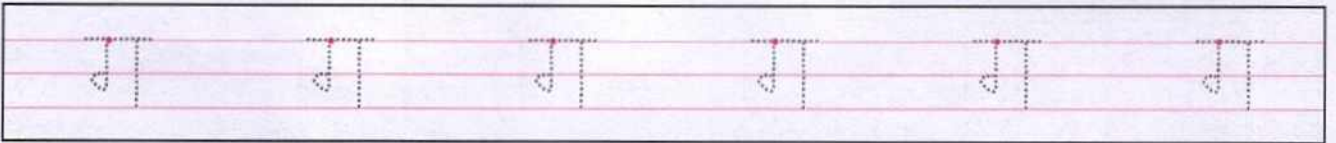
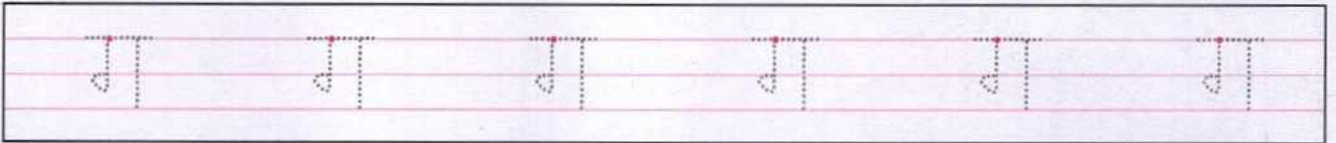
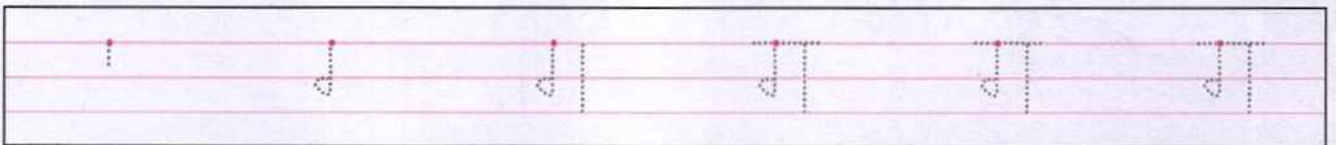

gha

घ



घड़ी

(ghadi) Watch

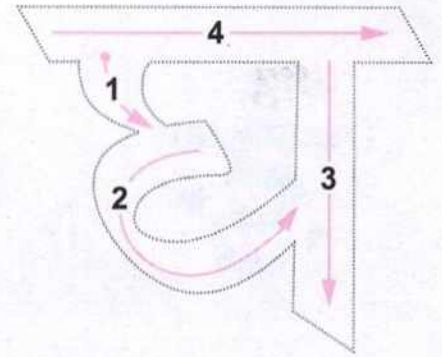

घर

(ghar) Home



घड़ा (ghada)

Earthen water-pot

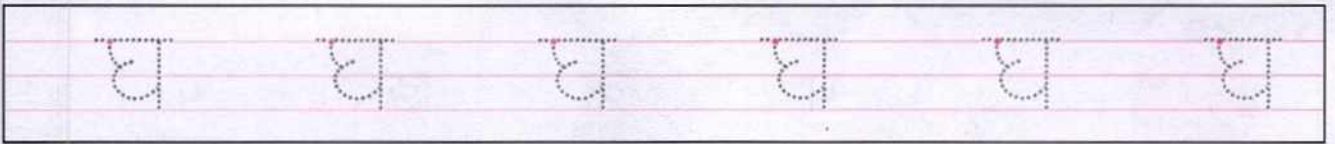
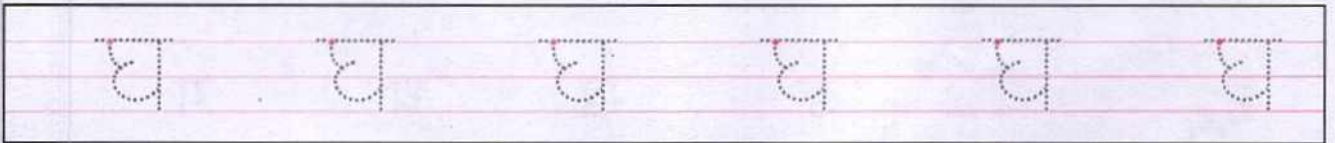
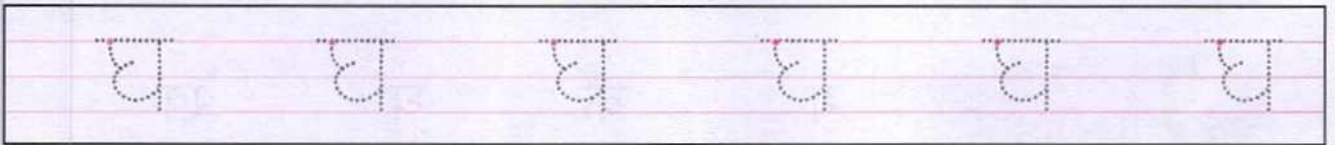
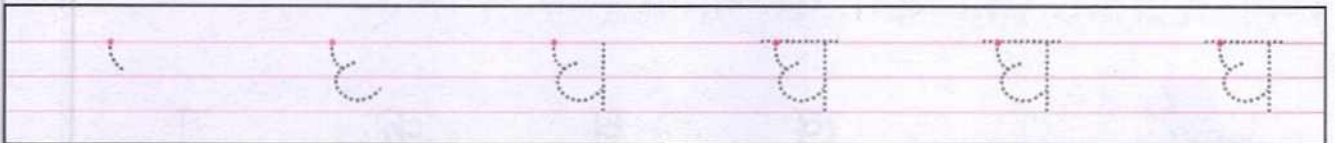

ang

ङ

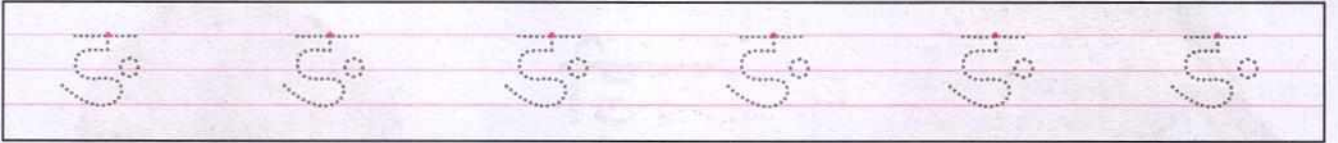
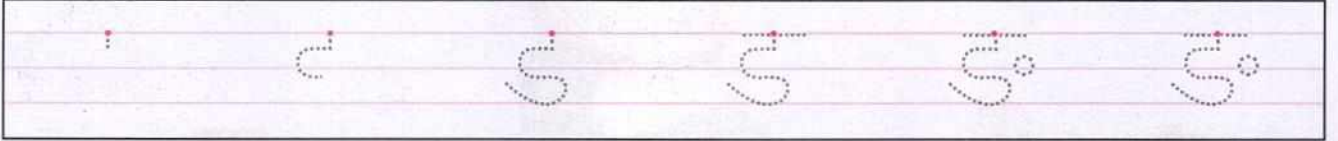
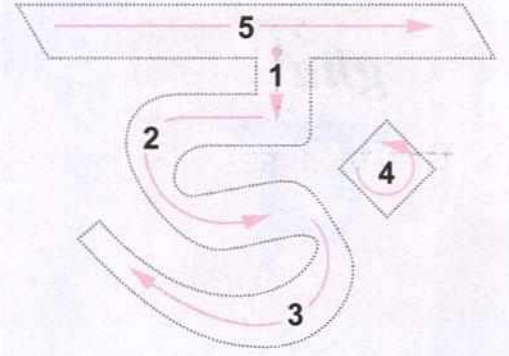

गतिविधि

चित्र देखकर सही वर्ण पर गोला ○ लगाइए—



ख घ क ग



ग क घ ख



ङ ख घ ग



घ क ङ ग



व्यंजन शक्तिविधि (क से ड)

- चित्र पहचानकर उनके नाम का पहला वर्ण बोलिए और लिखिए—



....डी

....रगोश



....मले



च-वर्ण

cha

च

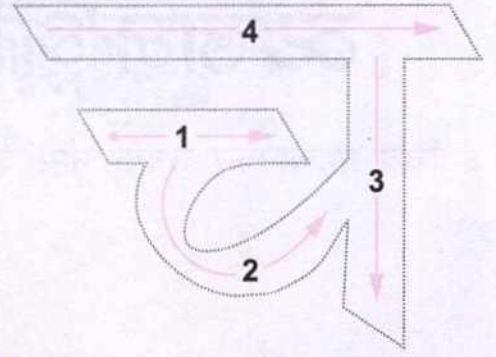

चटाई
(chataai) Mat

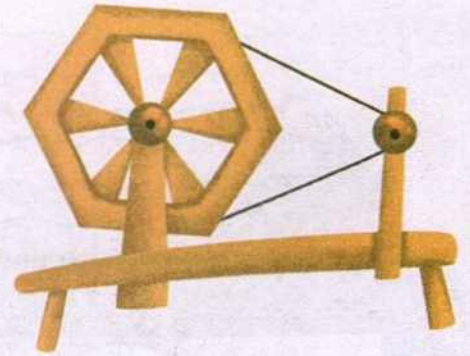

चटनी
(chatani) Sauce

चरखा (charkha)
Spinning wheel

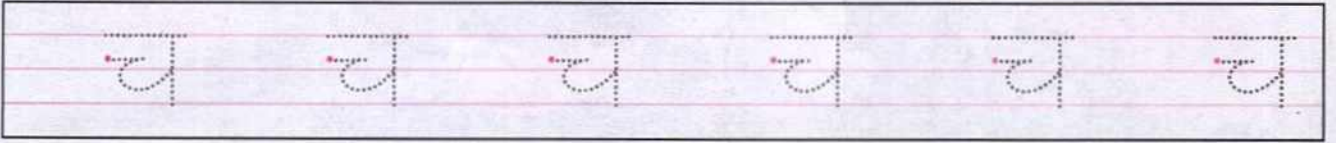
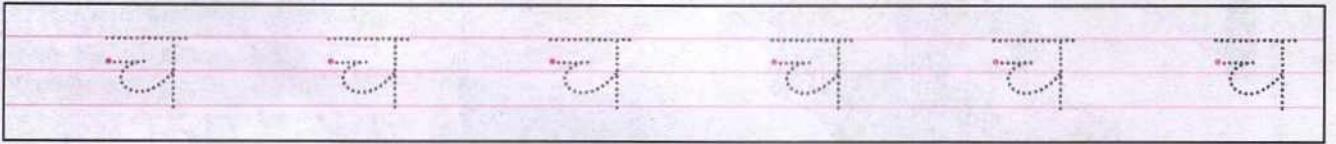
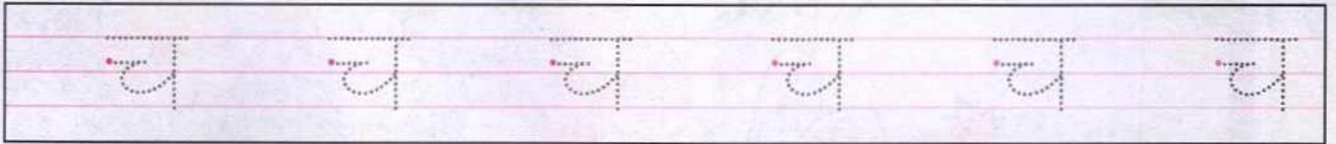
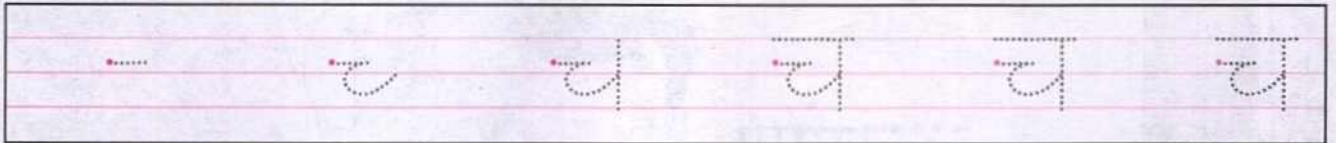

chha

छ

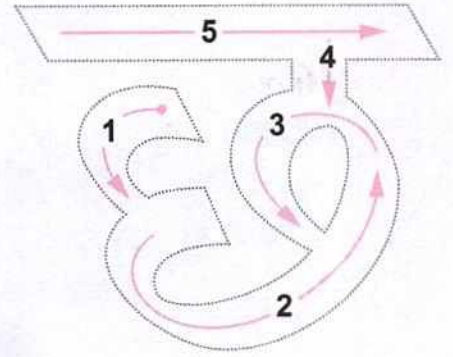

छतरी

(chhattree) Umbrella



छलनी

(chhalnee) Sieve



छड़ी

(chhadee) Stick

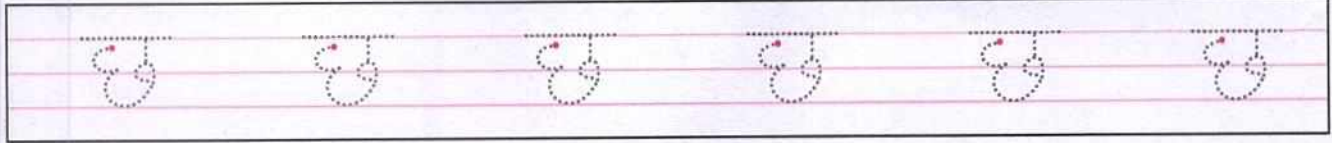
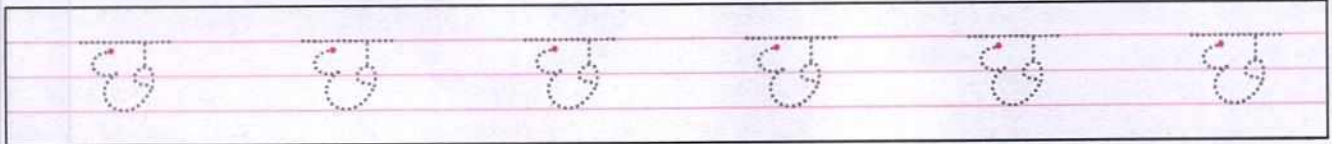
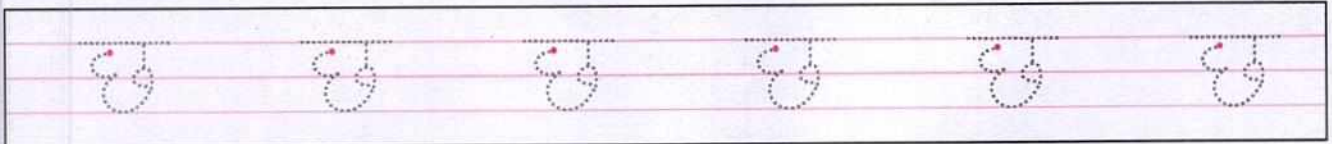
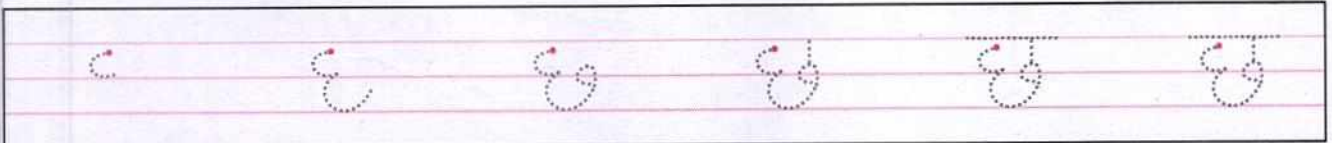

ja

ज

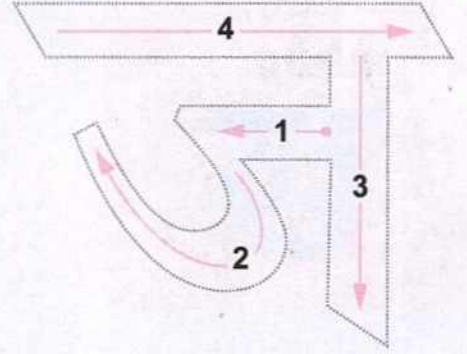

जहाज़

(jahaaz) Aeroplane



जलेबी

(jalebi) Rouded sweet



जग

(jag) Jug

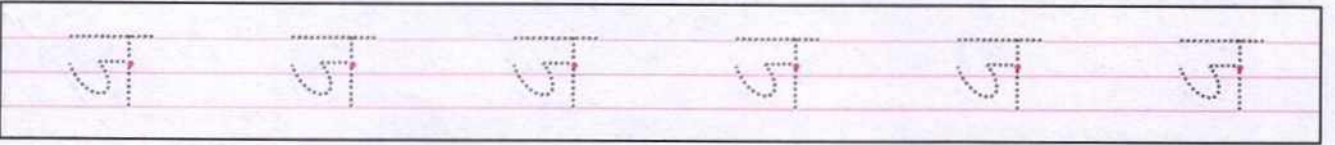
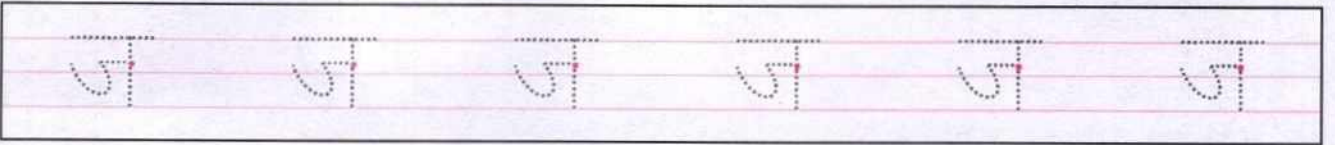
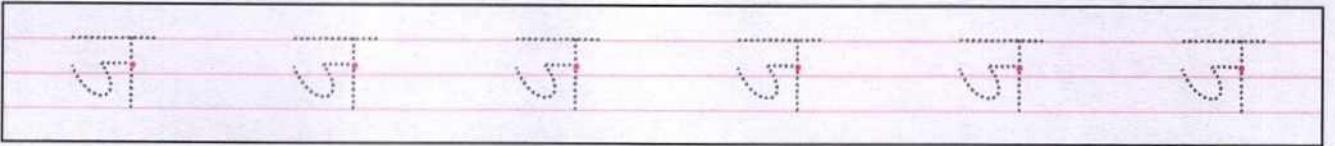
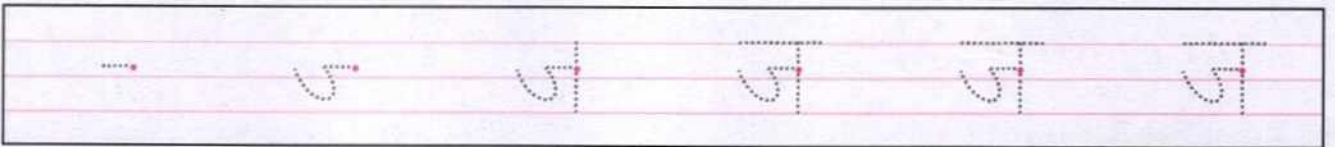

jha

झ

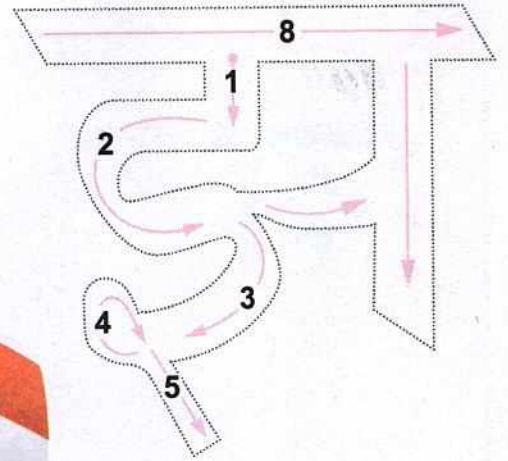

झरना

(jharna) Water fall



झंडा

(jhanda) Flag



झूला

(jhoola) Swing

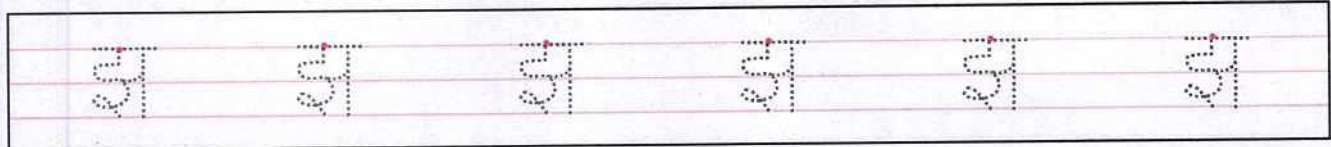
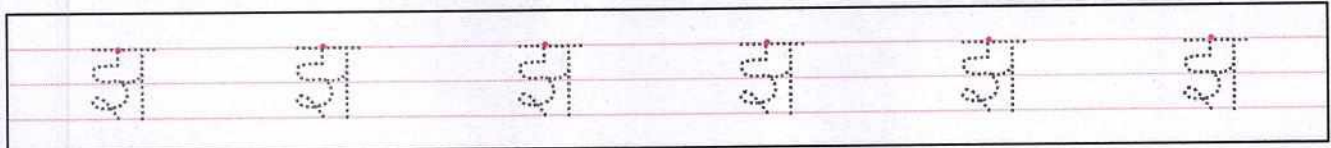
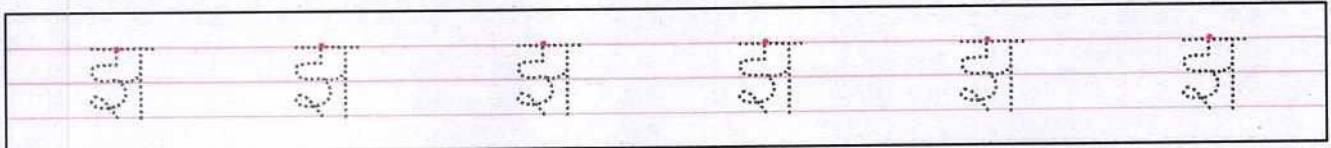
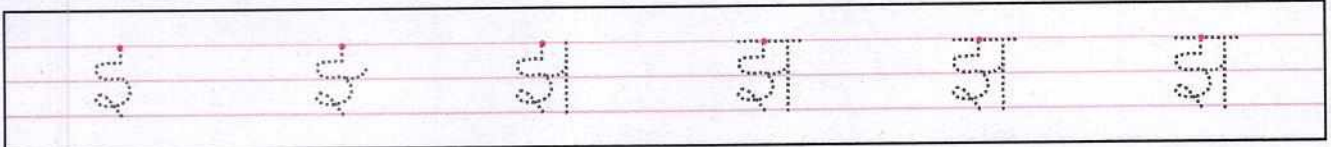

nya

अ

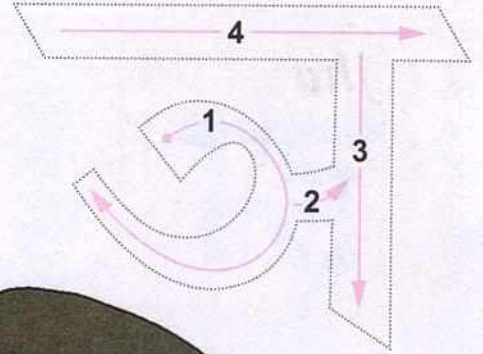

मञ्जन
(manjan) Toothpowder

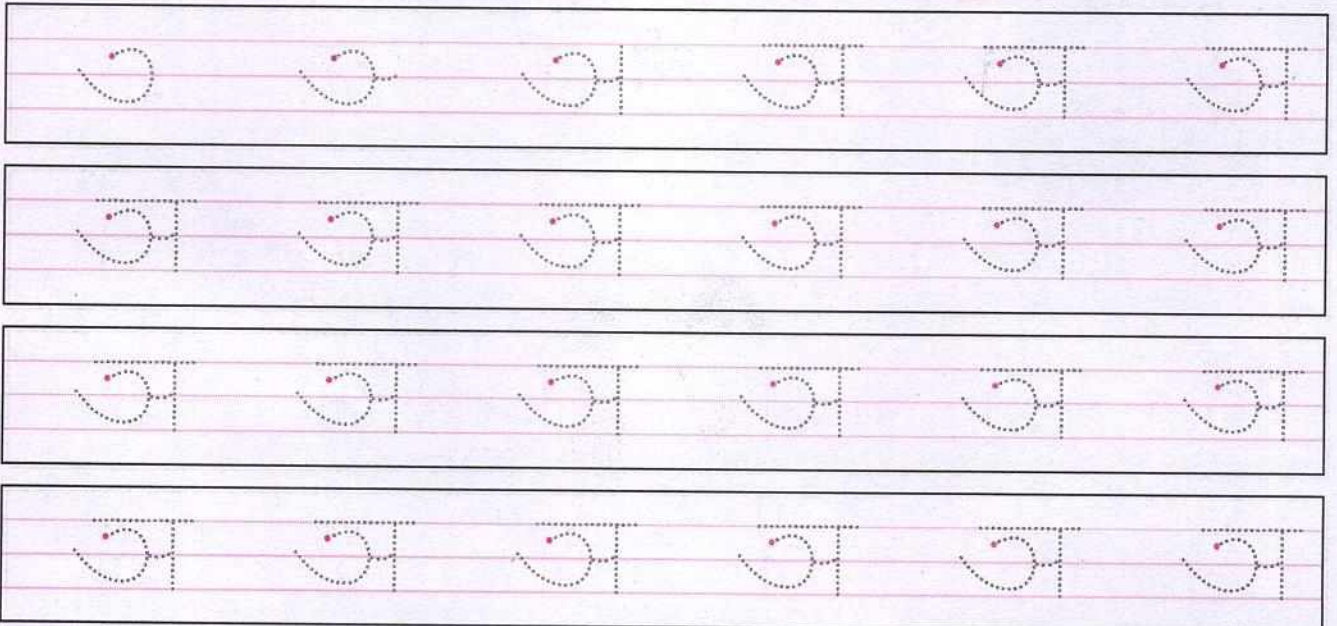
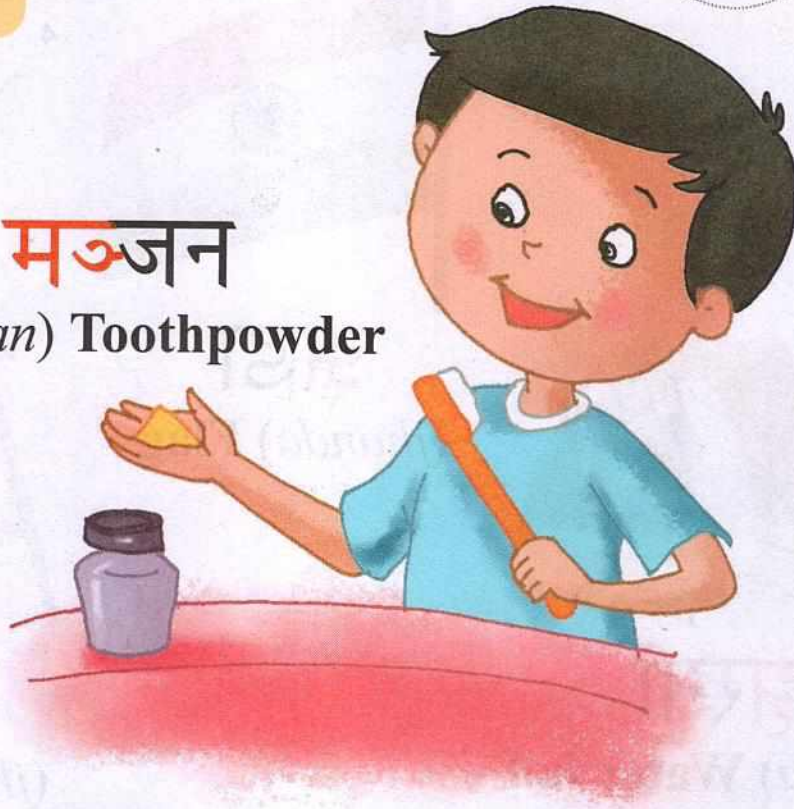

शक्तिविधि

चित्र पहचानिए और वर्ग पहेली में उसके नाम के खानों में रंग भरिए—



छ	ज	हा	ज़	छ
डी	च	टा	ई	त
च	र	खा	झ	री
त	ब	ला	र	झं
ज	ले	बी	ना	डा

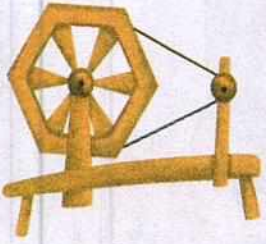

व्यंजन गतिविधि (च से ज)

....डा



- चित्र पहचानकर उनके नाम का पहला वर्ण बोलिए और लिखिए—

....तरी



....रखा



मज़े का एक दिन (चित्रपठन)

आज रविवार है। छुट्टी का दिन है। पापा ने सुबह उठते ही कहा
“आज हम सब घूमने जाएँगे। पिकी और पिंटू जल्दी तैयार हो
जाओ...

चित्र देखकर बताइए कि आज इन सबने अपना दिन कैसे
बिताया?

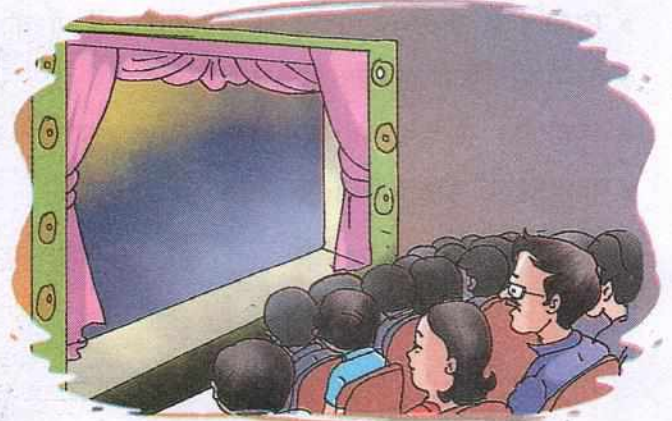



अध्यापन संकेत

- बच्चों से पूछें कि आज का दिन खास क्यों है? इस गतिविधि से बच्चों की अवलोकन क्षमता एवं मौखिक अभिव्यक्ति का विकास होगा।
- अध्यापिका सर्वप्रथम बच्चों से ध्यानपूर्वक चित्रों को देखने के लिए कहें।
- बच्चों से चित्रों पर बातचीत करें।
- बच्चों की मौखिक अभिव्यक्ति के लिए प्रोत्साहित कर उनकी सराहना करें।
- बातचीत के दौरान चित्र पर आधारित प्रश्न पूछें।



ट-वर्ण

ta

ट

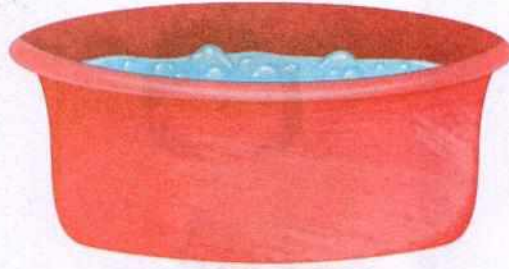
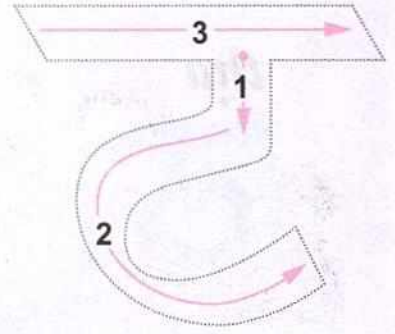

टब

(tab) Tub



टमाटर

(tamatar) Tomato

टहनी

(tahani) Branch

ट	ट	ट	ट	ट	ट
ट	ट	ट	ट	ट	ट
ट	ट	ट	ट	ट	ट
ट	ट	ट	ट	ट	ट



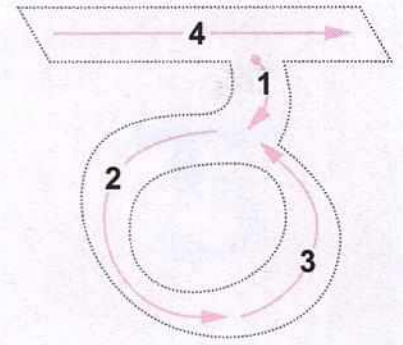

ठक-ठक
(thak-thak) Rap

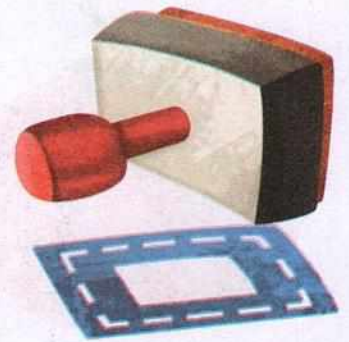

ठठेरा (thathera)
Coppersmith

ठप्पा
(thappa) Stamp

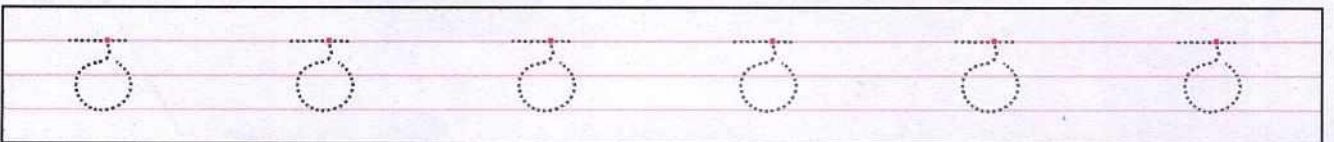
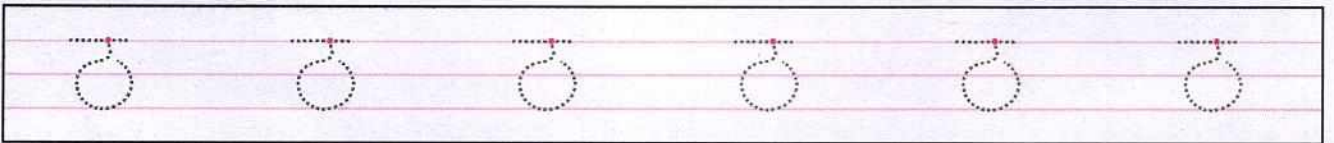
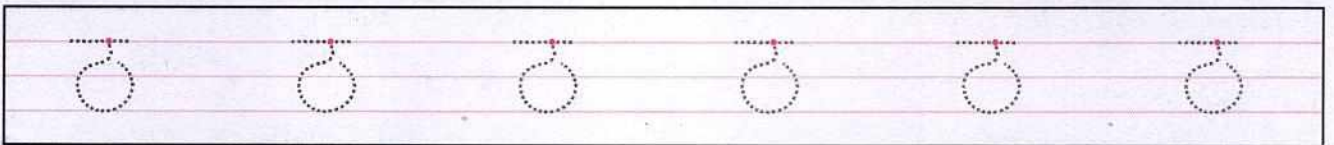
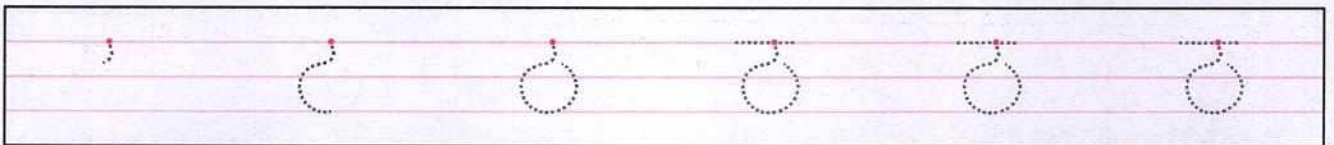

da

ड

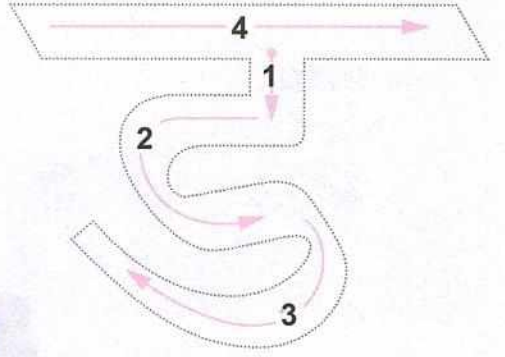

डमरू (Damroo)
Small drum



डलिया
(dalia) Basket



डस्टर
(daster) Duster

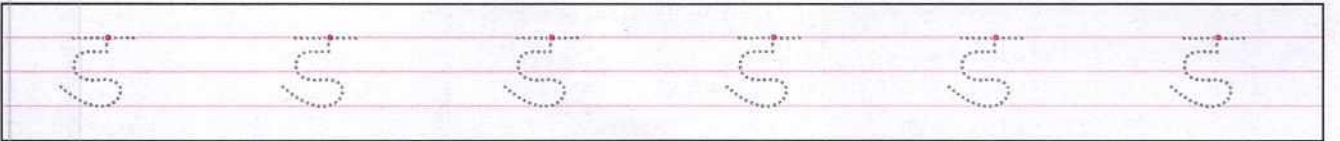
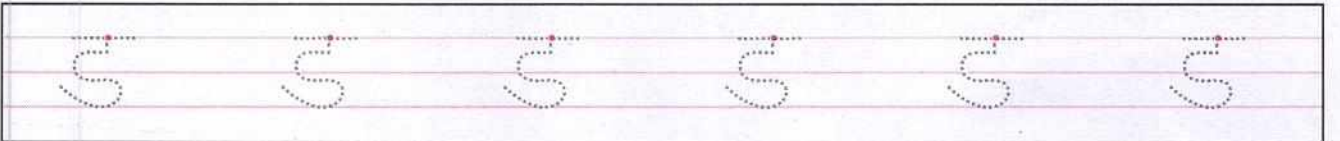
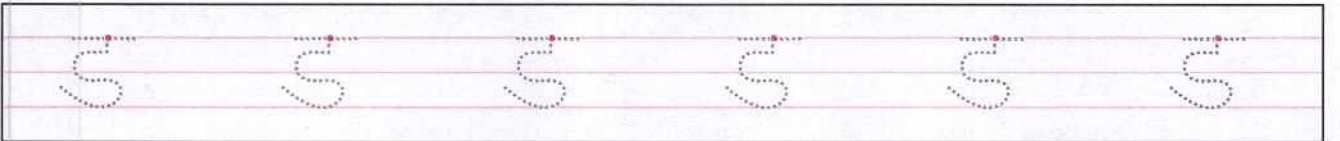
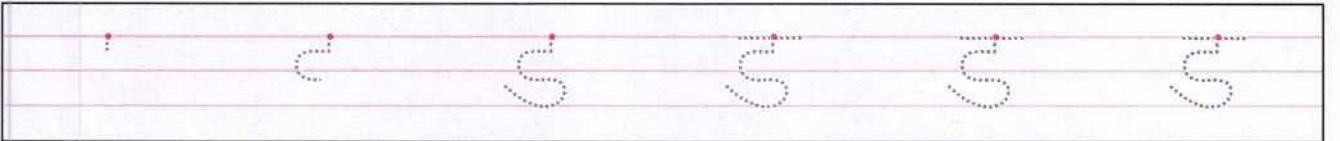

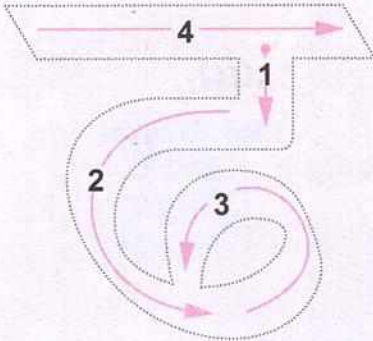

ढक्कन
(*dhakkan*) Lid



ढपली (*dhaplee*)
Tambourine



ढलान (*dhalaan*)
Steepness

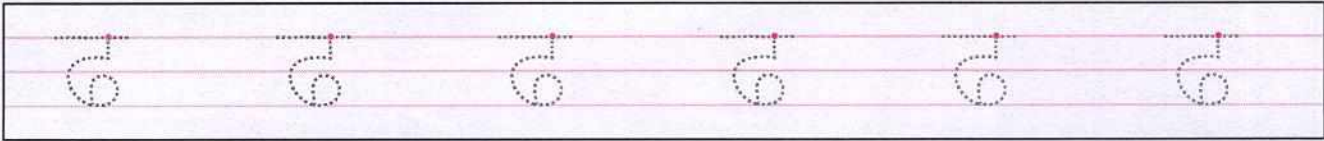
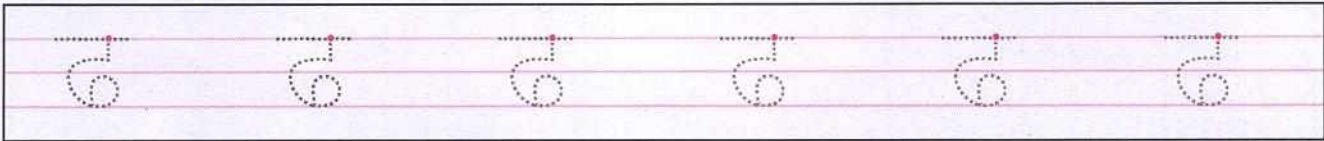
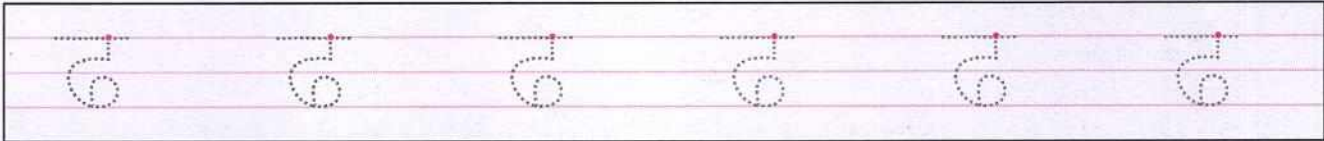
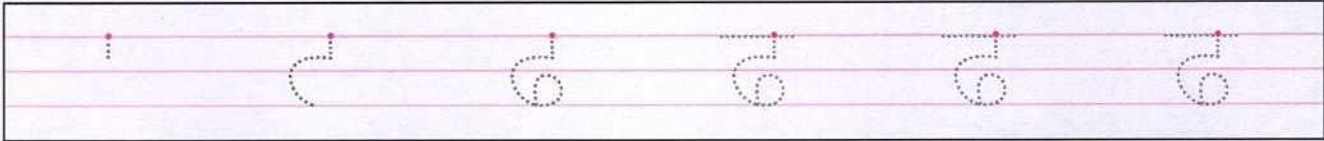

rna

ण

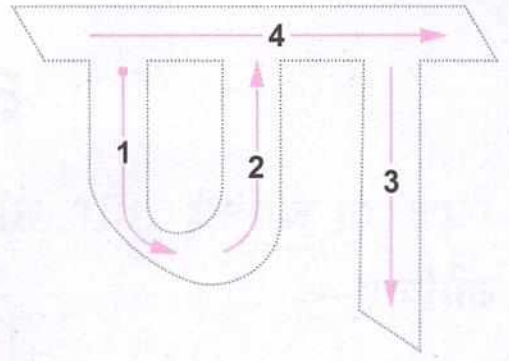

आभूषण

(abhushan) Jewellery



किरण

(kiran) Ray



बाण

(baann) Arrow

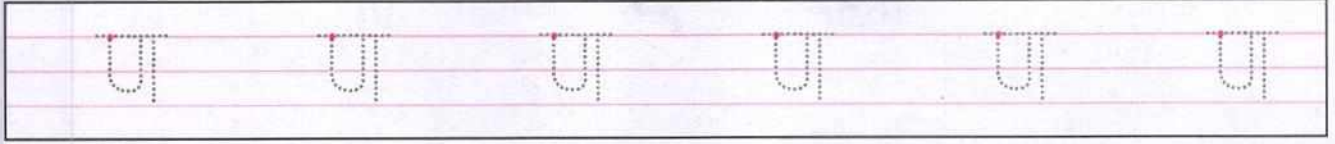
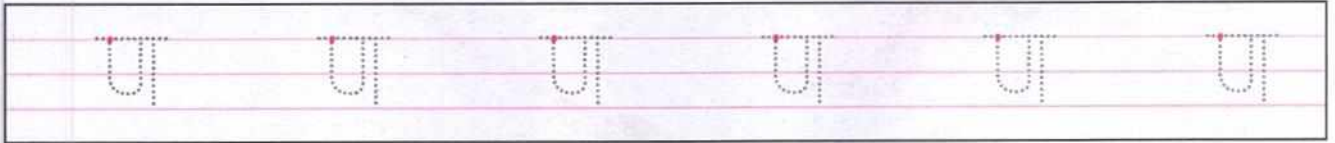
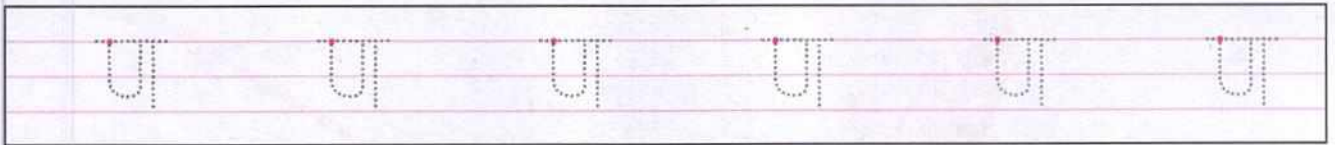
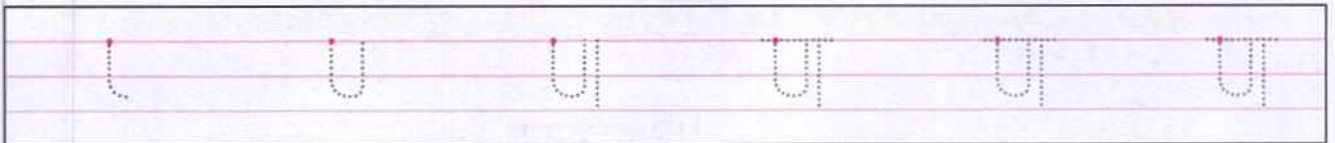

गतिविधि

चित्र पहचानिए और उचित स्थान पर वर्ण लिखकर शब्द पूरा कीजिए-



.....माटर

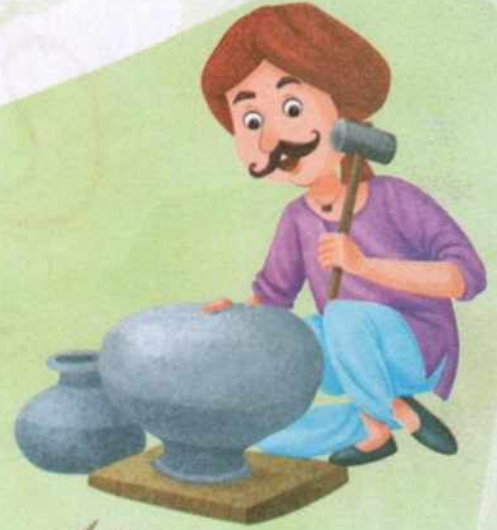

.....ठेरा

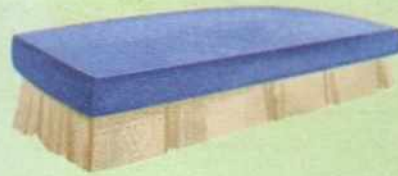

.....स्टर



.....पली

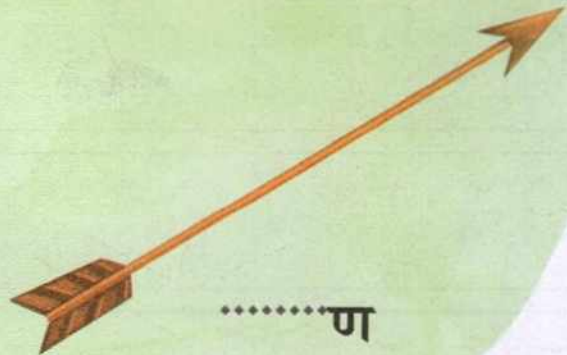

.....ण



ब्यंजन गतिविधि (ट से ण)

● चित्र पहचानकर उनके नाम का पहला वर्ण बोलिए और लिखिए—

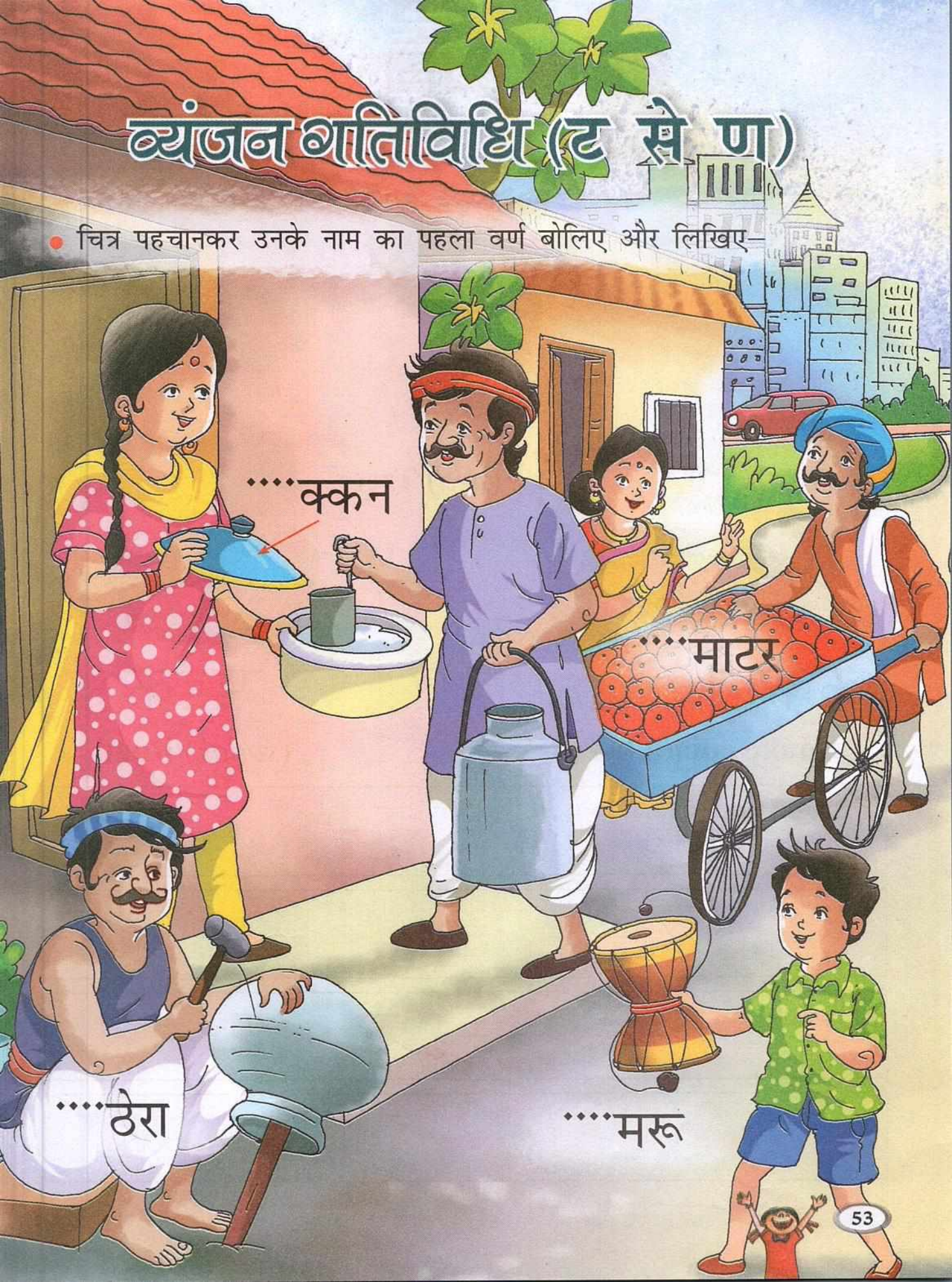

....ककन

....माटर

....ठेरा

....मरू

आगत ध्वनियाँ

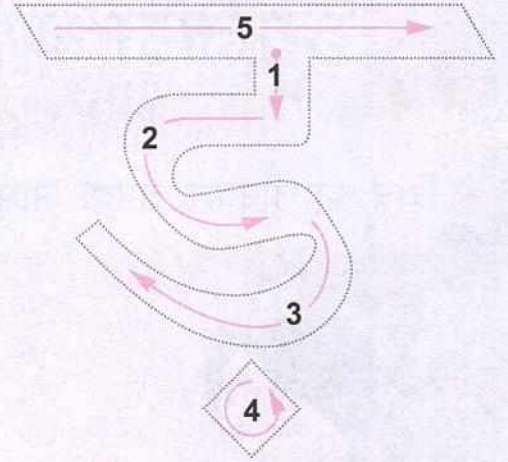

पेड़ (ped) Tree

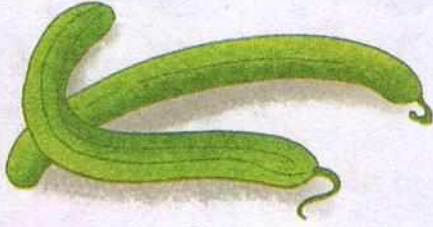

ककड़ी (kakadi)

Snake cucumber

सड़क

(sadak) Road

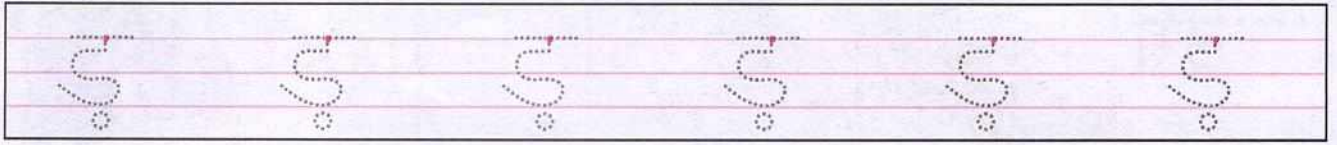
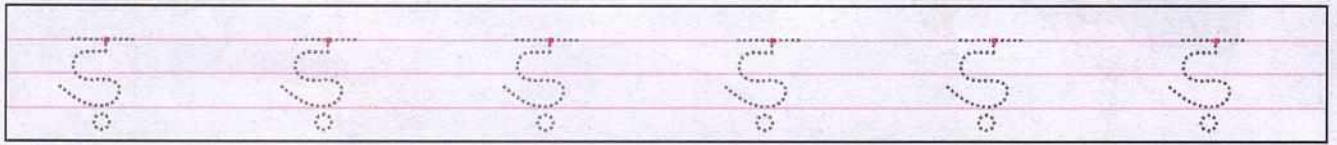
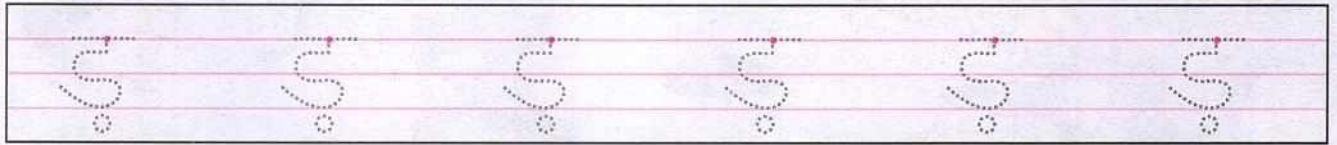
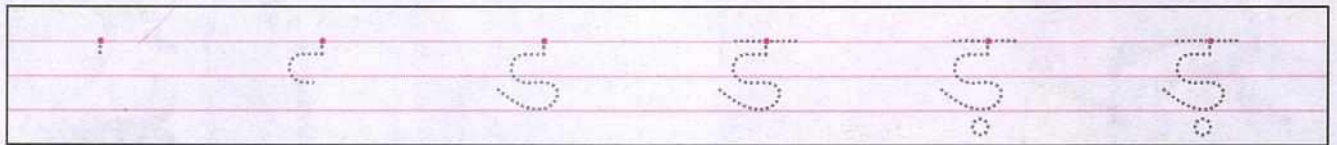

rdha

ढ

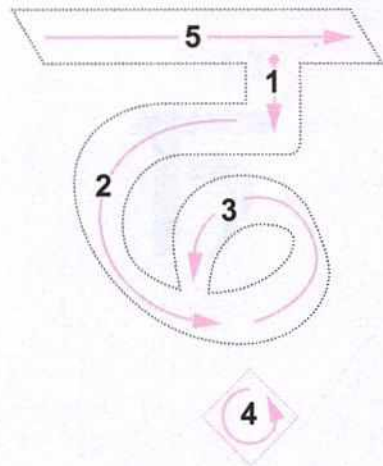

चढ

(chadh) Climb



गढ

(gadh) Fort

पढ

(padh) Read

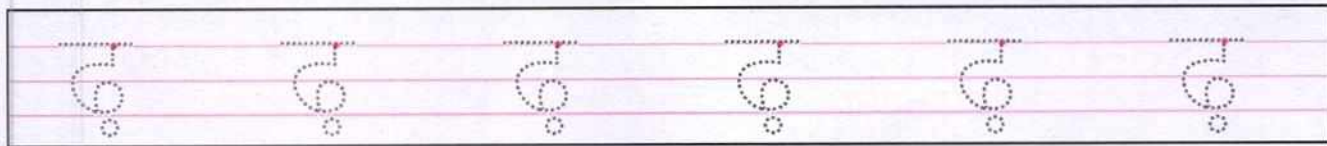
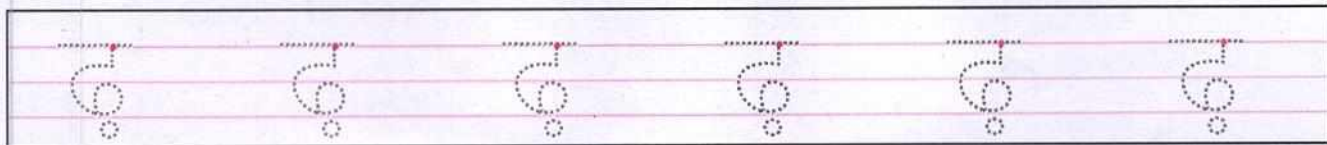
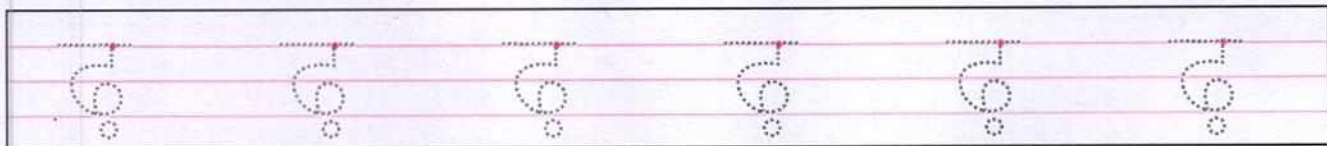
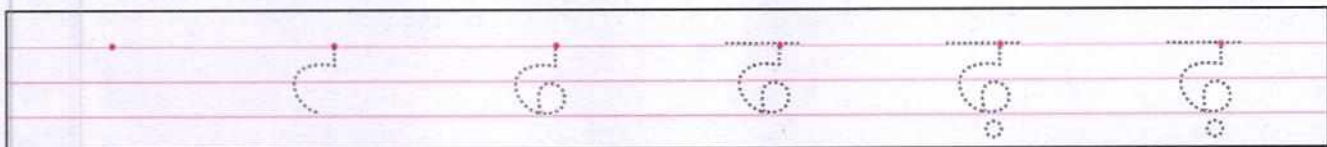



त-वर्ण

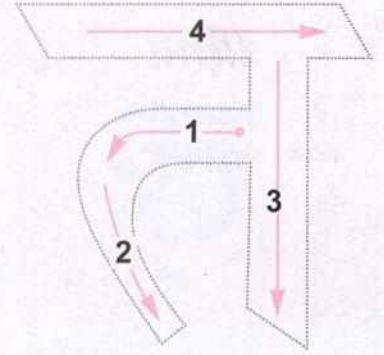

तरबूज़ (tarbooz) Watermelon

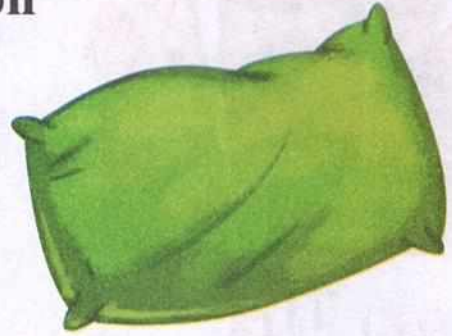

तबला (tabla) Tabla

तकिया (takia) Pillow

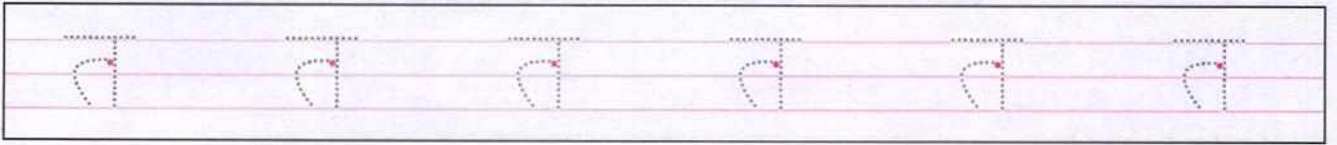
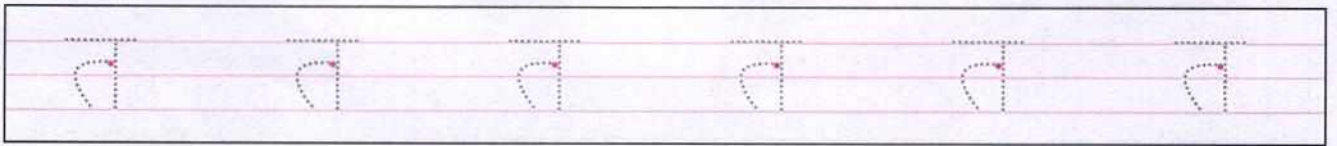
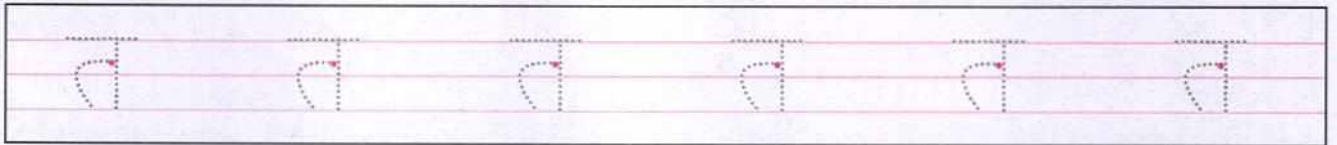
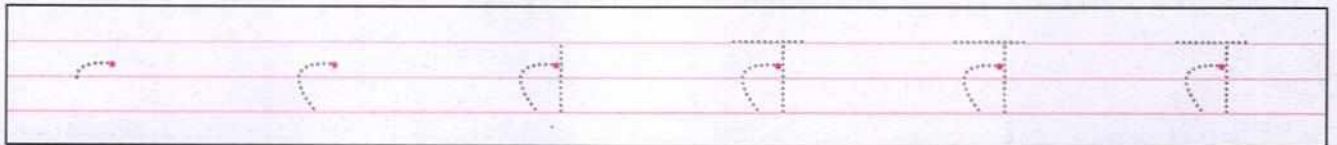

tha

थ

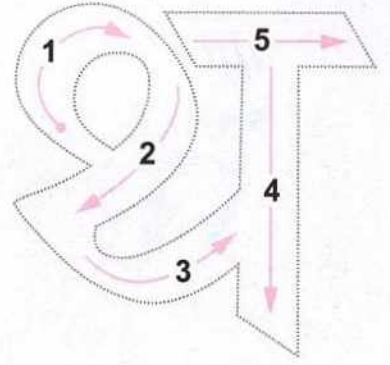

थकान

(thakaan) Tiredness



थर्मस

(tharmas) Flask

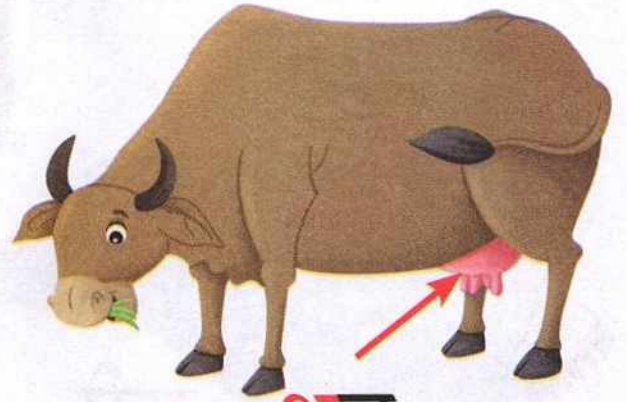

थन

(than) Dug

थ थ थ थ थ थ थ

थ थ थ थ थ थ थ

थ थ थ थ थ थ थ

थ थ थ थ थ थ थ



da

द

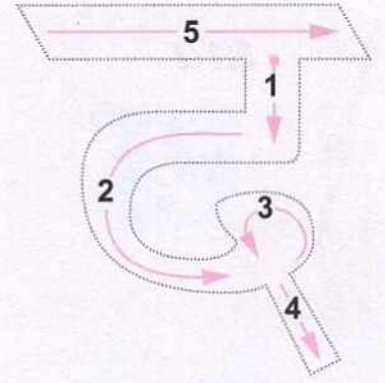

दरवाजा
(darvaza) Door

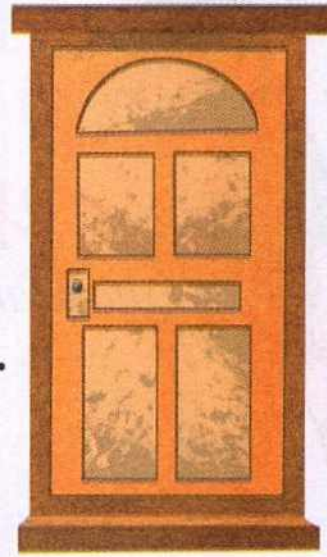

दरी
(dari) Mat



दवात
(davaat) Inkpot

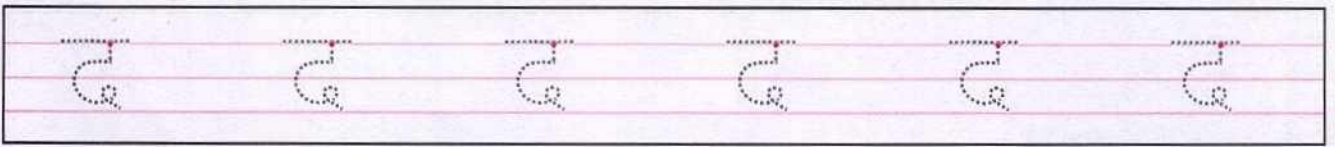
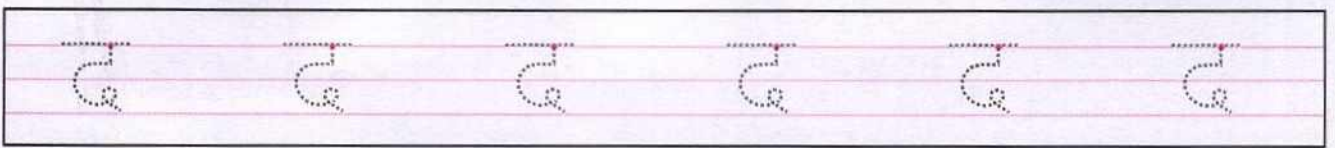
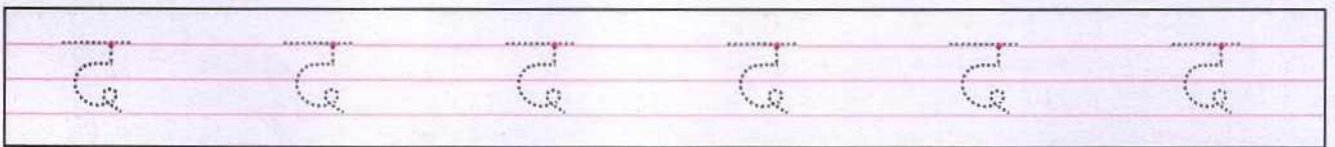
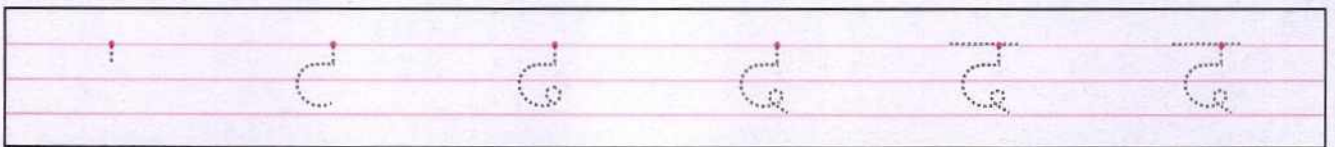

dha

ध

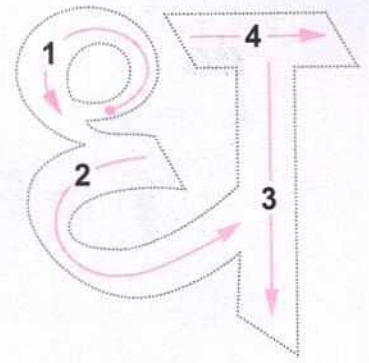

धनुष

(dhanush) Bow



धनिया

(dhania) coriander

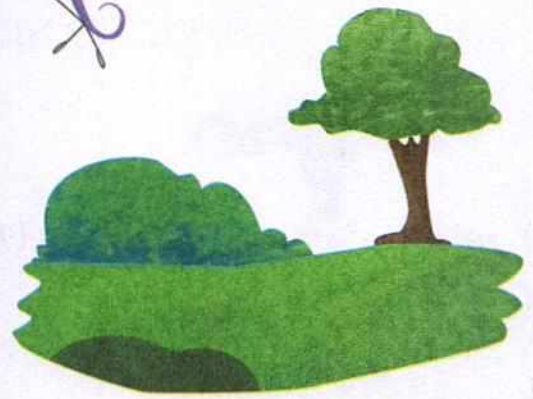

धरती

(dharti) Earth

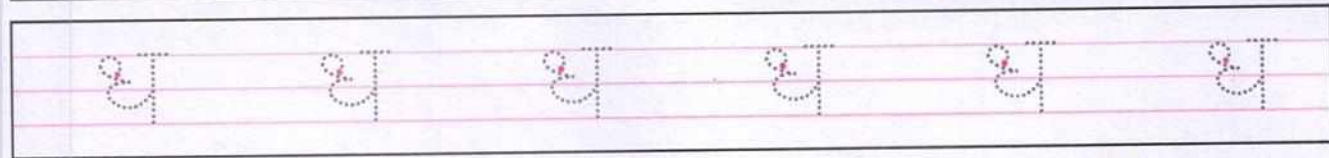
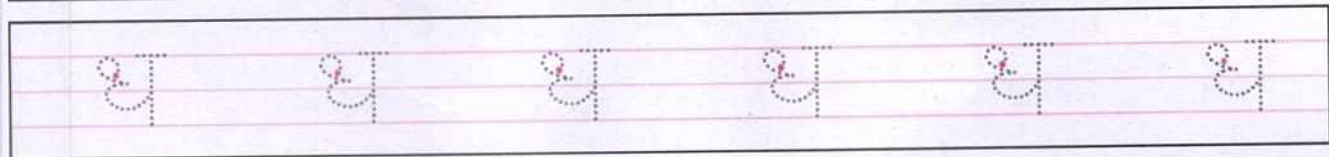
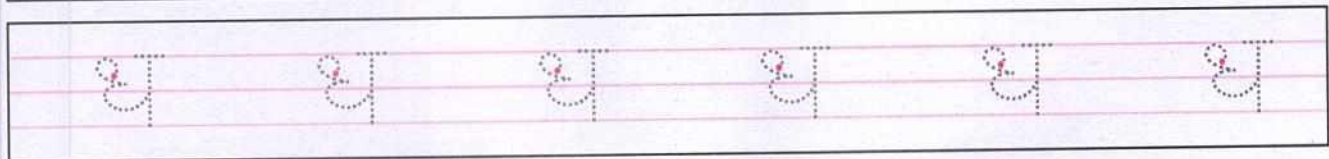
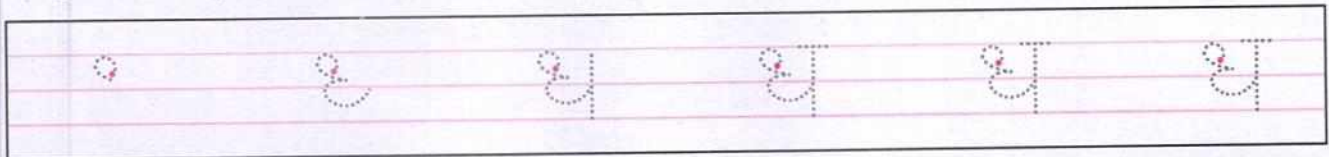

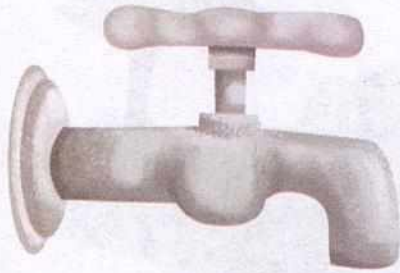
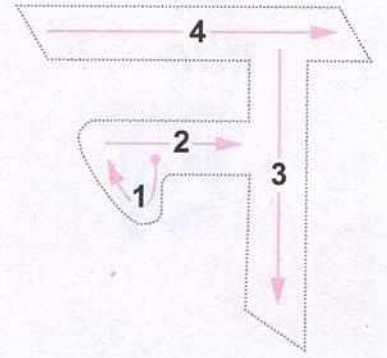

नमक
(*namak*) Salt

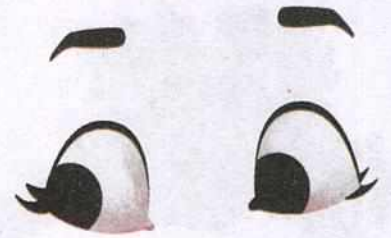

नल
(*nal*) Tap

नयन
(*nayan*) Eyes

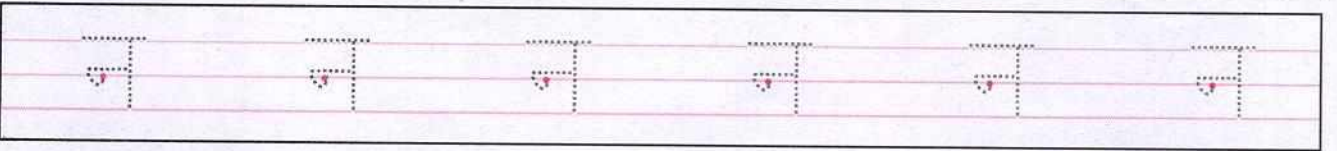
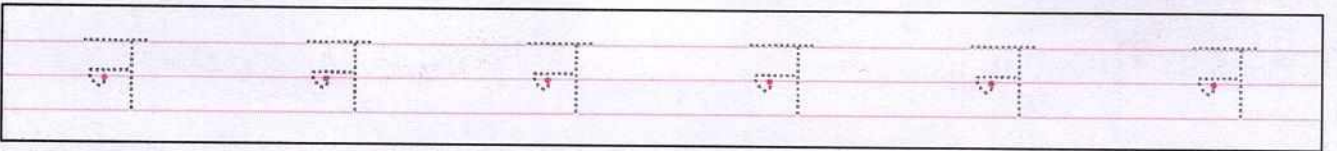
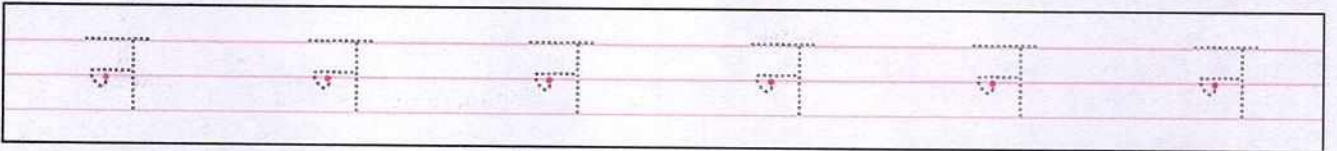
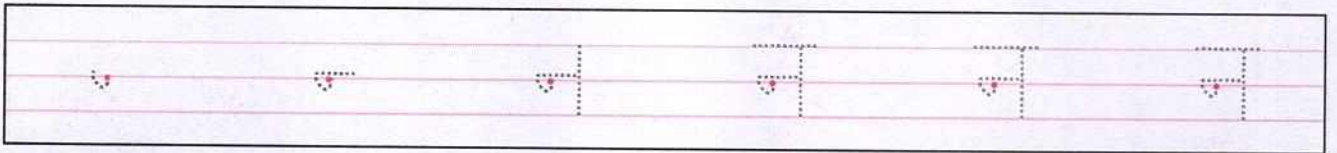

गतिविधि

चित्र देखिए और सही वर्ण पर सही का (✓) निशान लगाइए-



द

त



थ

ध

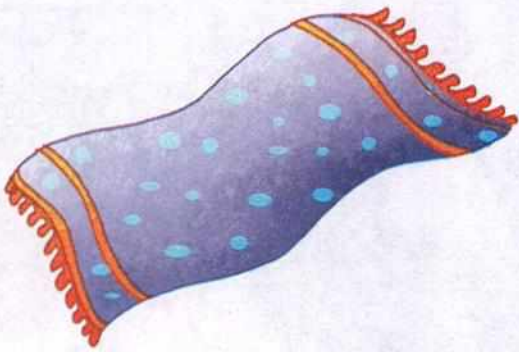

न

द

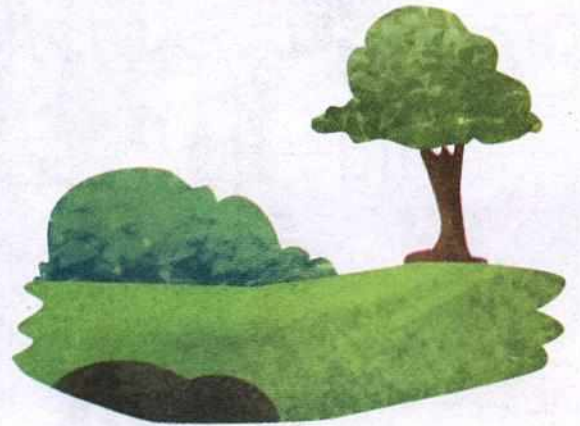

त

ध



व्यंजन गतिविधि (त से न)

- चित्र पहचानकर उनके नाम का पहला वर्ण बोलिए और लिखिए—

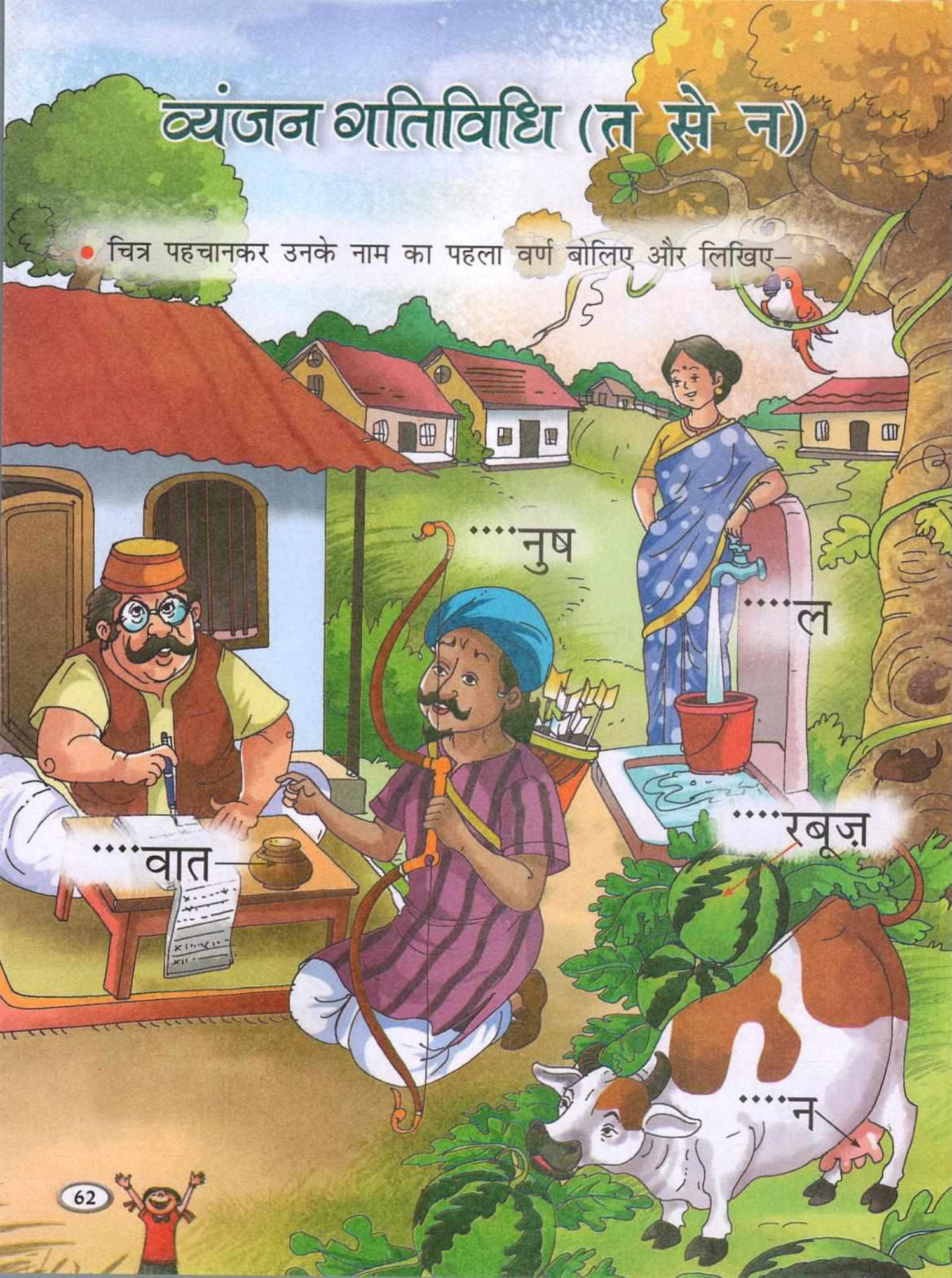

....नुष

....ल

....रबूज़

....वात

....न



प-वर्ण

pa

प

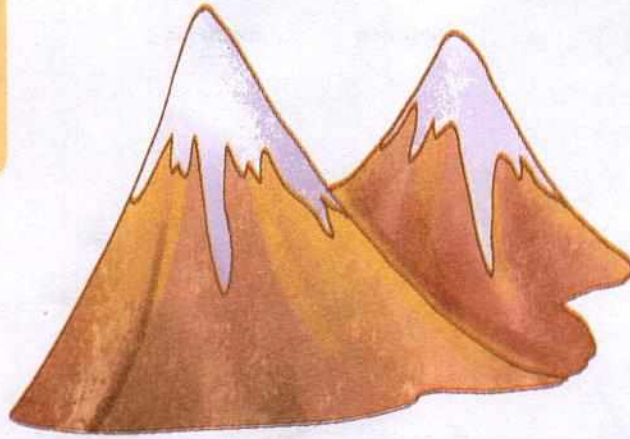
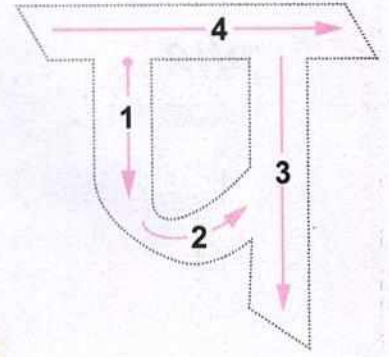

पहाड़

(pahaad) Mountain



पतंग

(patang) Kite



पहिया

(pahia) Wheel

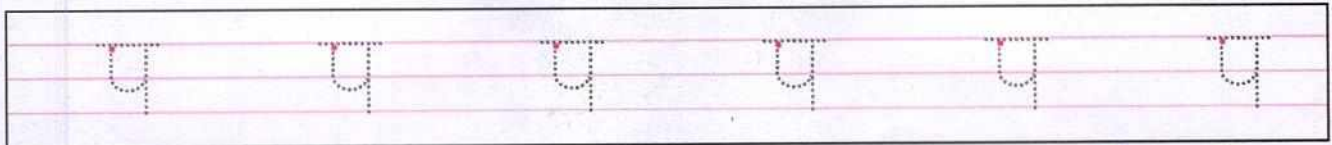
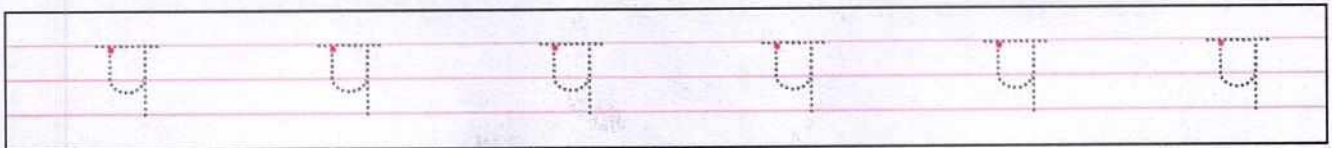
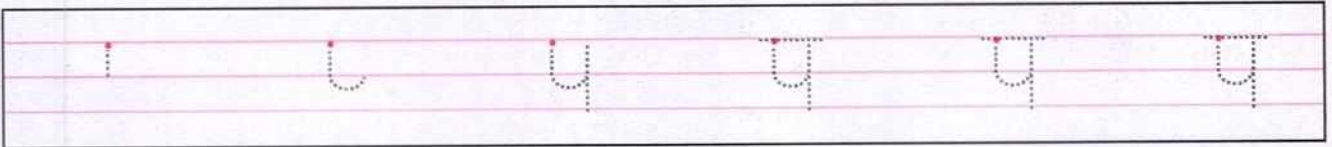

pha

फ

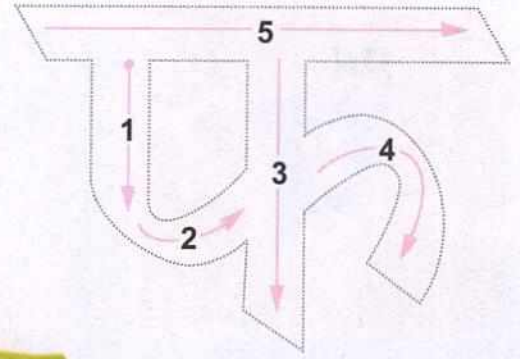

फली

(phalee) Beans



फ़सल

(phasal) Crop



फल

(phal) Fruits

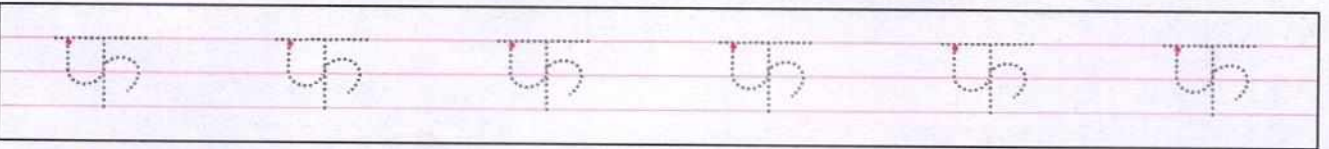
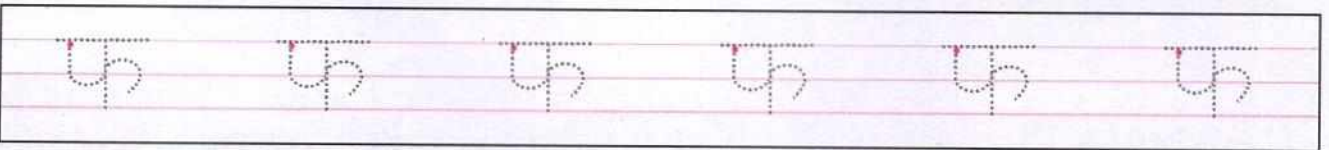
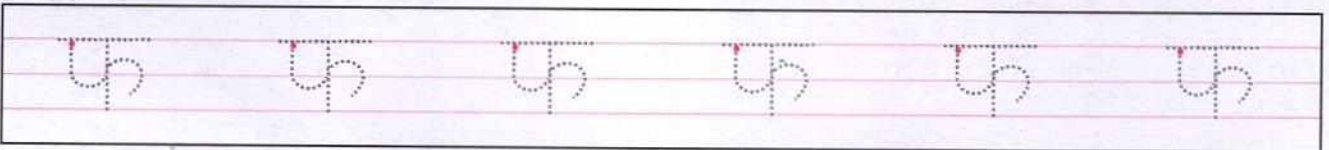

ba

ब



बगीचा

(baghicha) Park

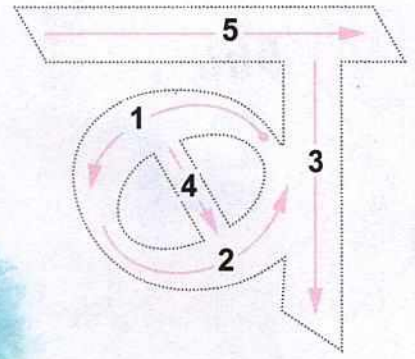

बकरी

(bakri) Goat

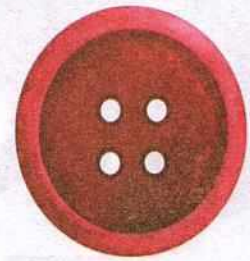

बटन

(batan) Button

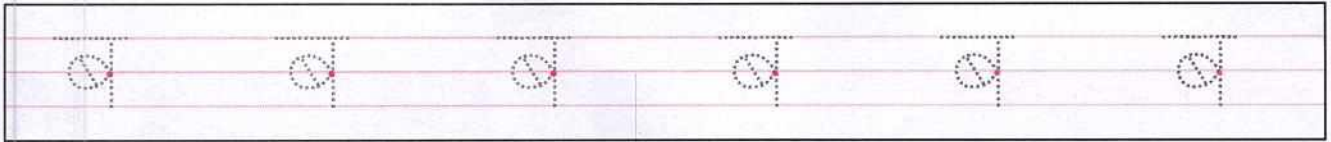
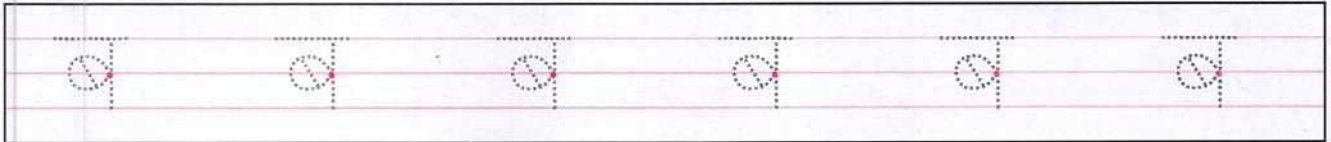
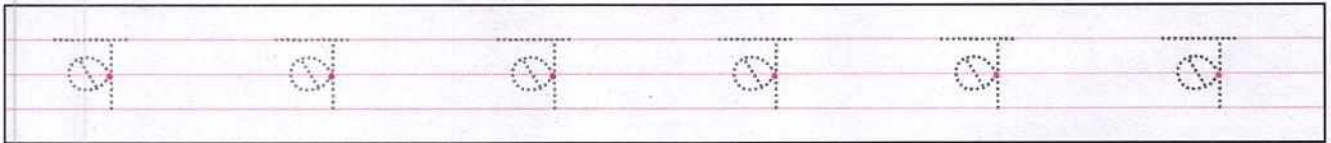
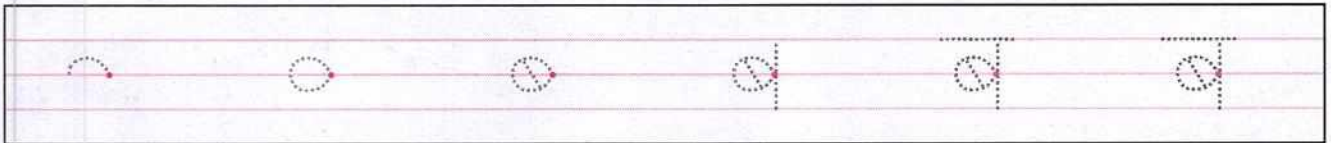

bha

भ

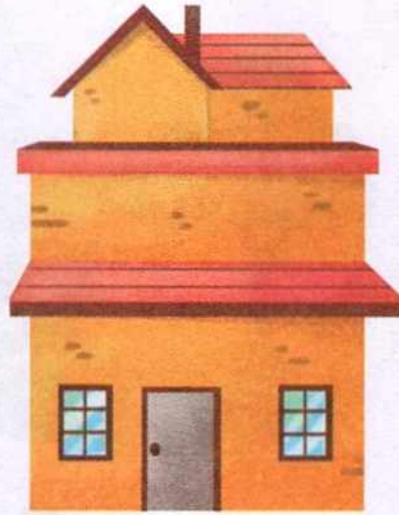

भवन

(bhavan) Mansion

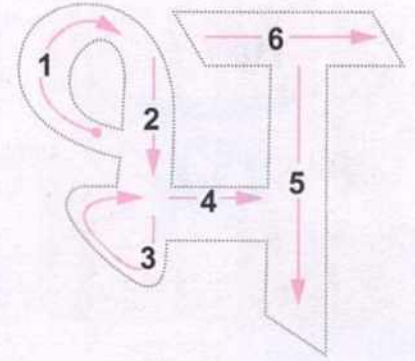

भालू

(bhaloo) Bear



भगौना

(bhagouna)

Cooking pot

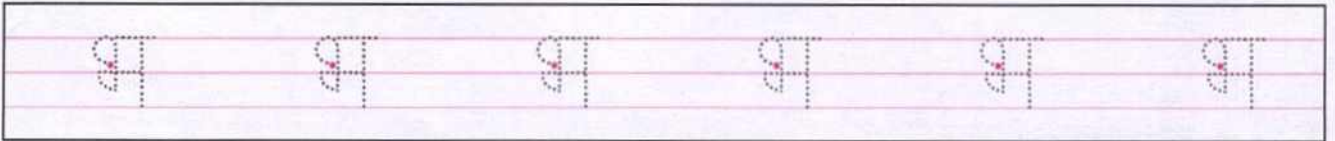
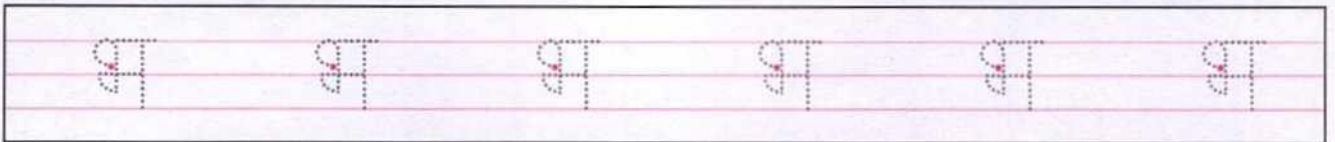
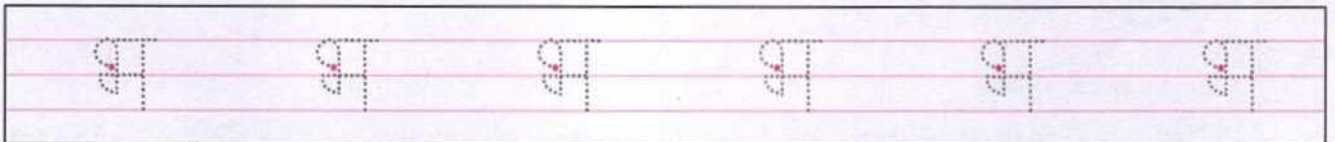
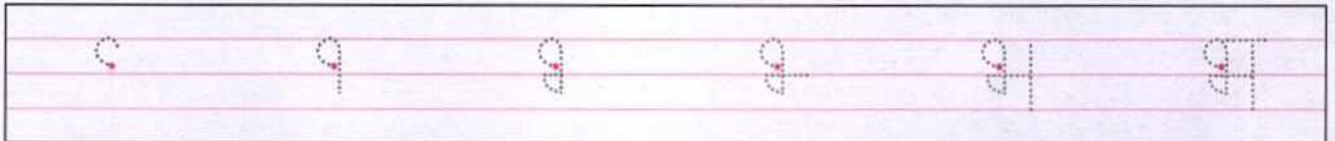

ma

म



मटर
(matar) Pea

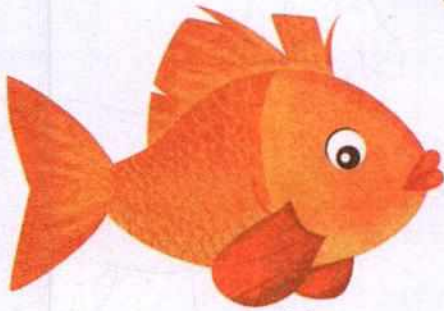
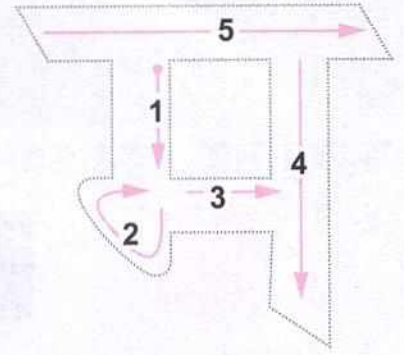

मछली
(machhalee) Fish



मकड़ी
(makadi) Spider

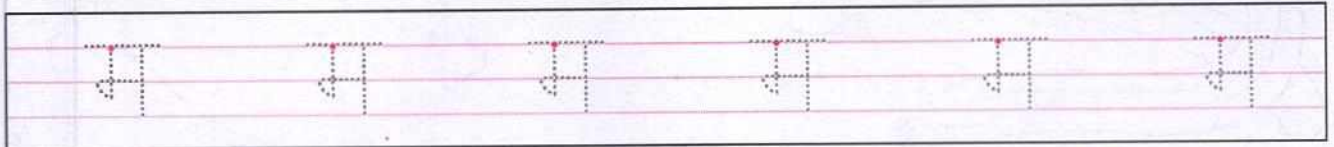
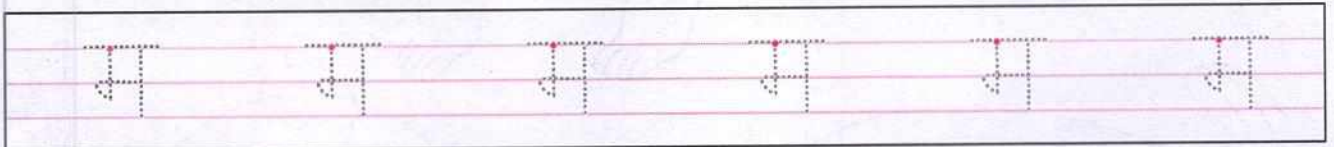
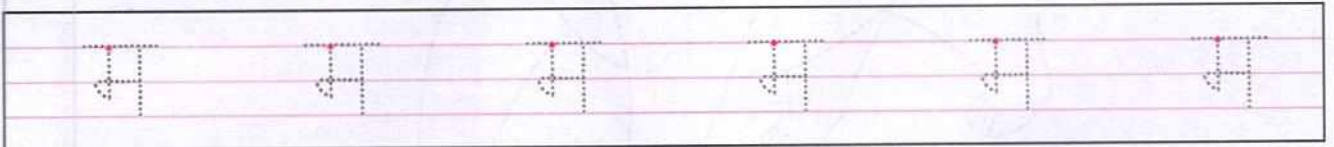
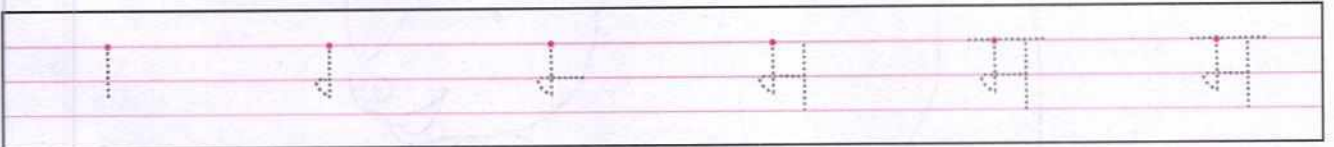

गतिविधि

पहचानिए, समझिए और चित्रों में रंग भरिए—



प



फ



ब



भ



म

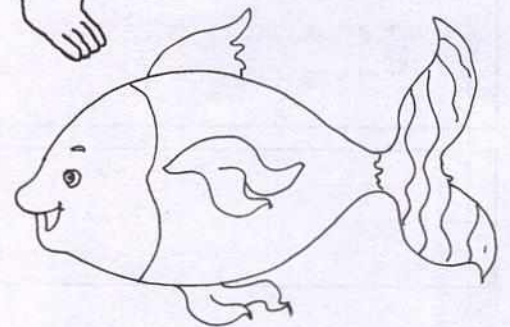
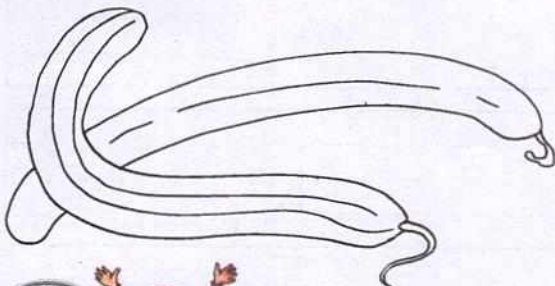
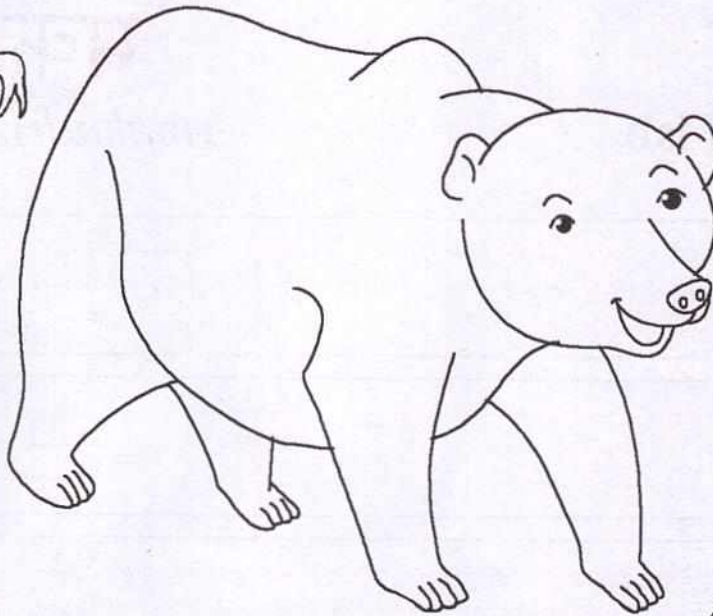
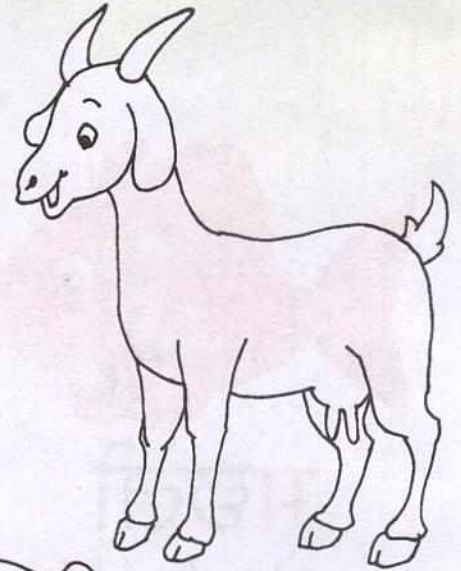
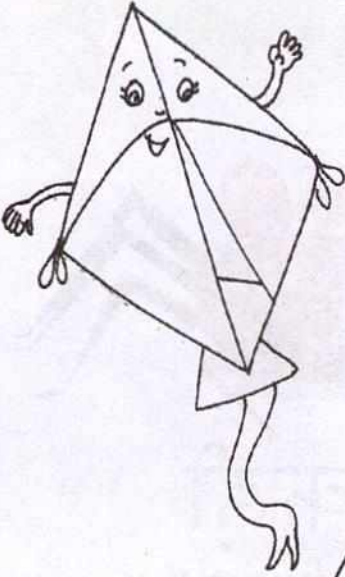

व्यंजन गतिविधि (प से म)



....तंग

- चित्र पहचानकर उनके नाम का पहला वर्ण बोलिए और लिखिए—



....लू



....करी



....ल



....छली



अंतस्थ व्यंजन

ya

य

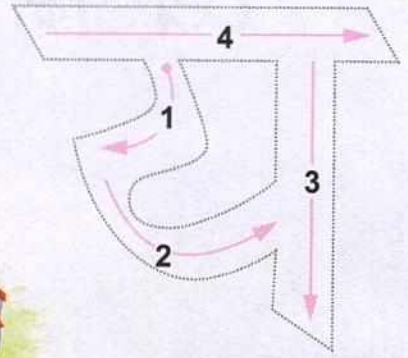

यज्ञ
(yagya) Yajna

यमुना
(yamuna) River



यंत्र
(yantra)
Instrument

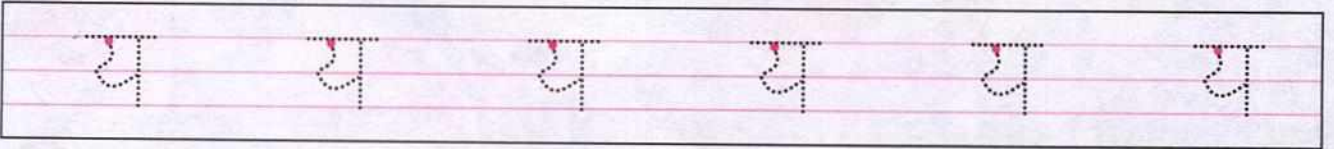
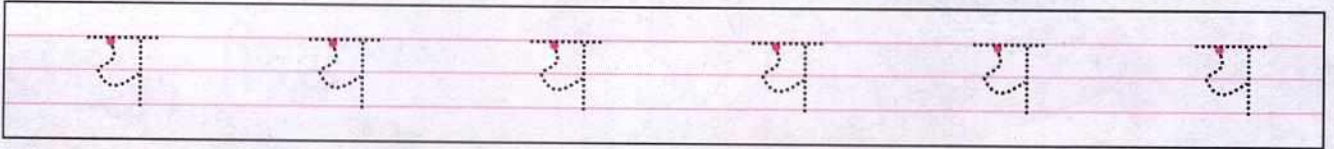
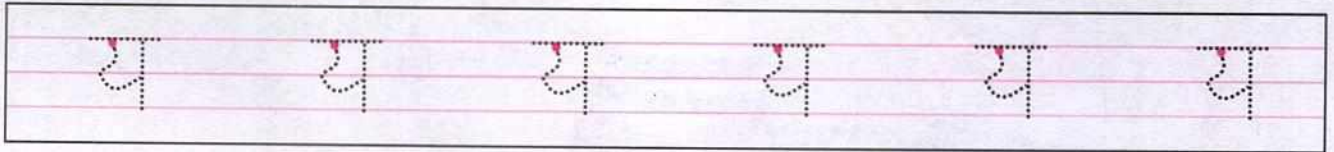
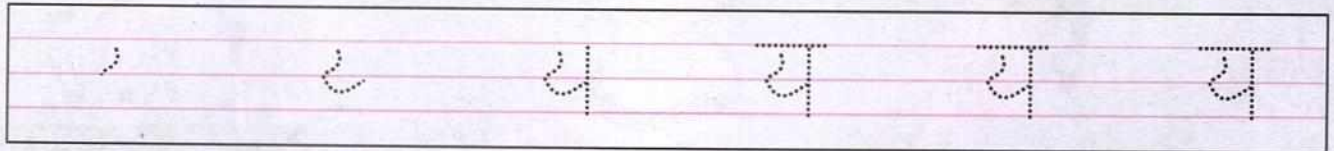

ra

र

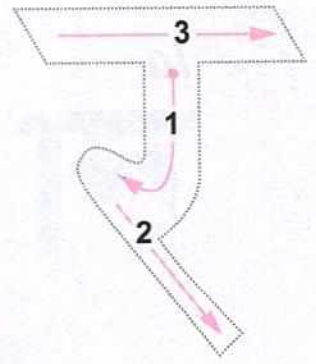

रस्सी

(rassee) Rope



रथ

(rath) Chariot

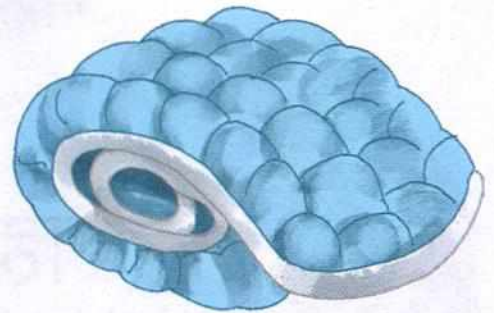

रज़ाई

(razai) Quilt

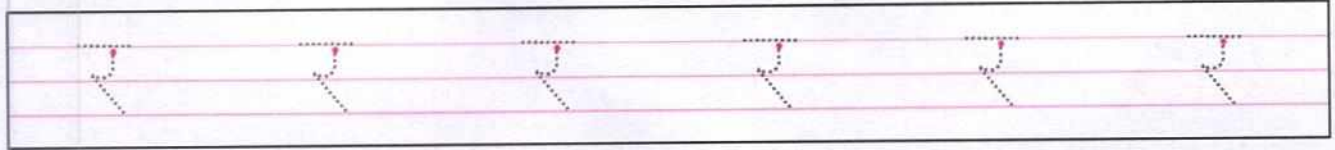
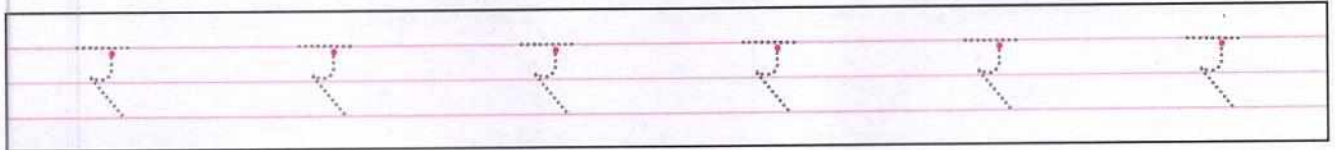
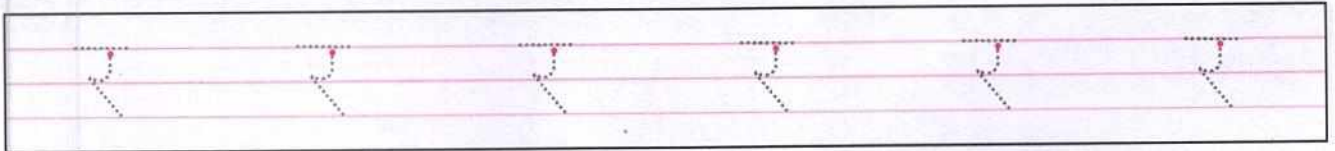
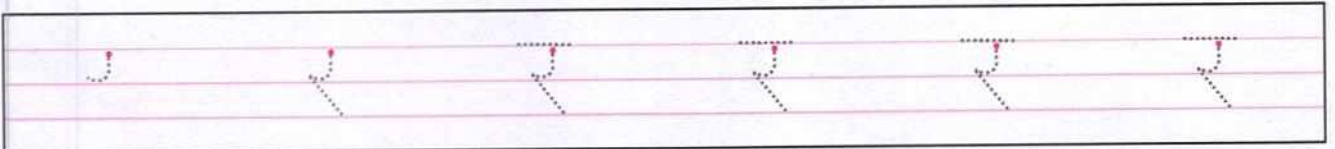

la

ल

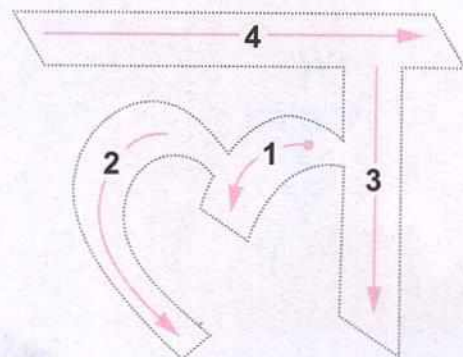

लट्टू
(lattoo) Top



लड़की
(ladakēe) Girl



लहर
(Lehar) Wave

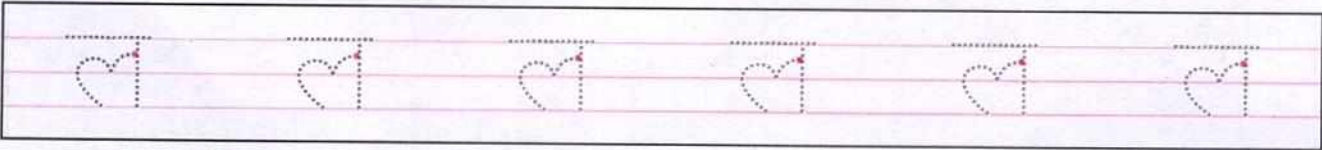
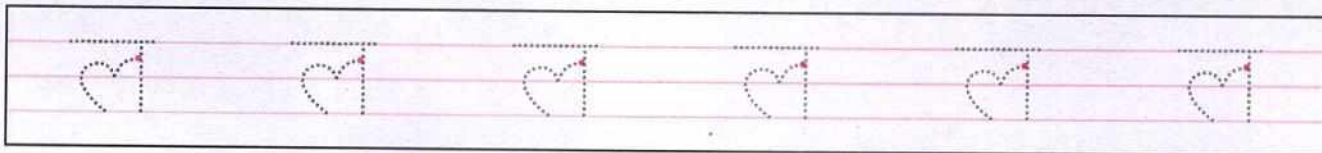
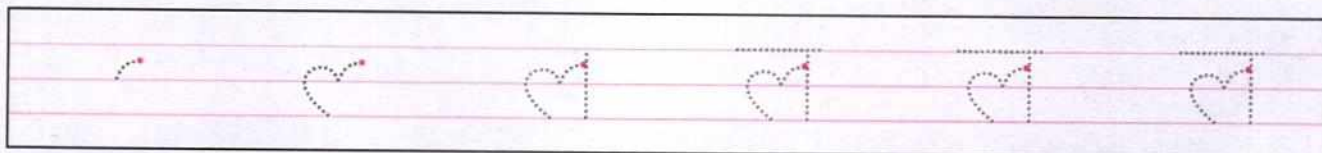

va

व



वन

(van) Forest



वस्त्र

(vastra) Clothes

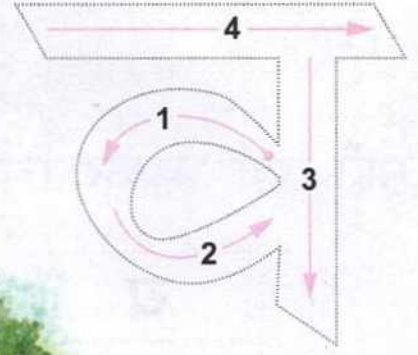

वक

(vak) Crane

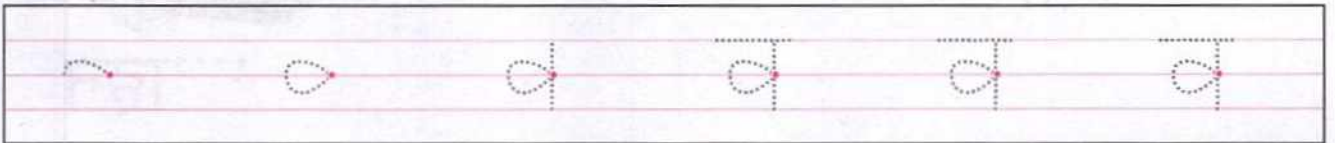

* य, र, ल, व वर्ण अंतस्थ व्यंजन कहलाते हैं।



गतिविधि

सही वर्ण भरकर चित्रों के नाम पूरे कीजिए—

य र ल व



....कील



....ीणा



....ोटी



....स्सी



....हन



....ङकी



....क



....ता



व्यंजन गतिविधि (य से व)

- चित्र पहचानकर उनके नाम का पहला वर्ण बोलिए और लिखिए—

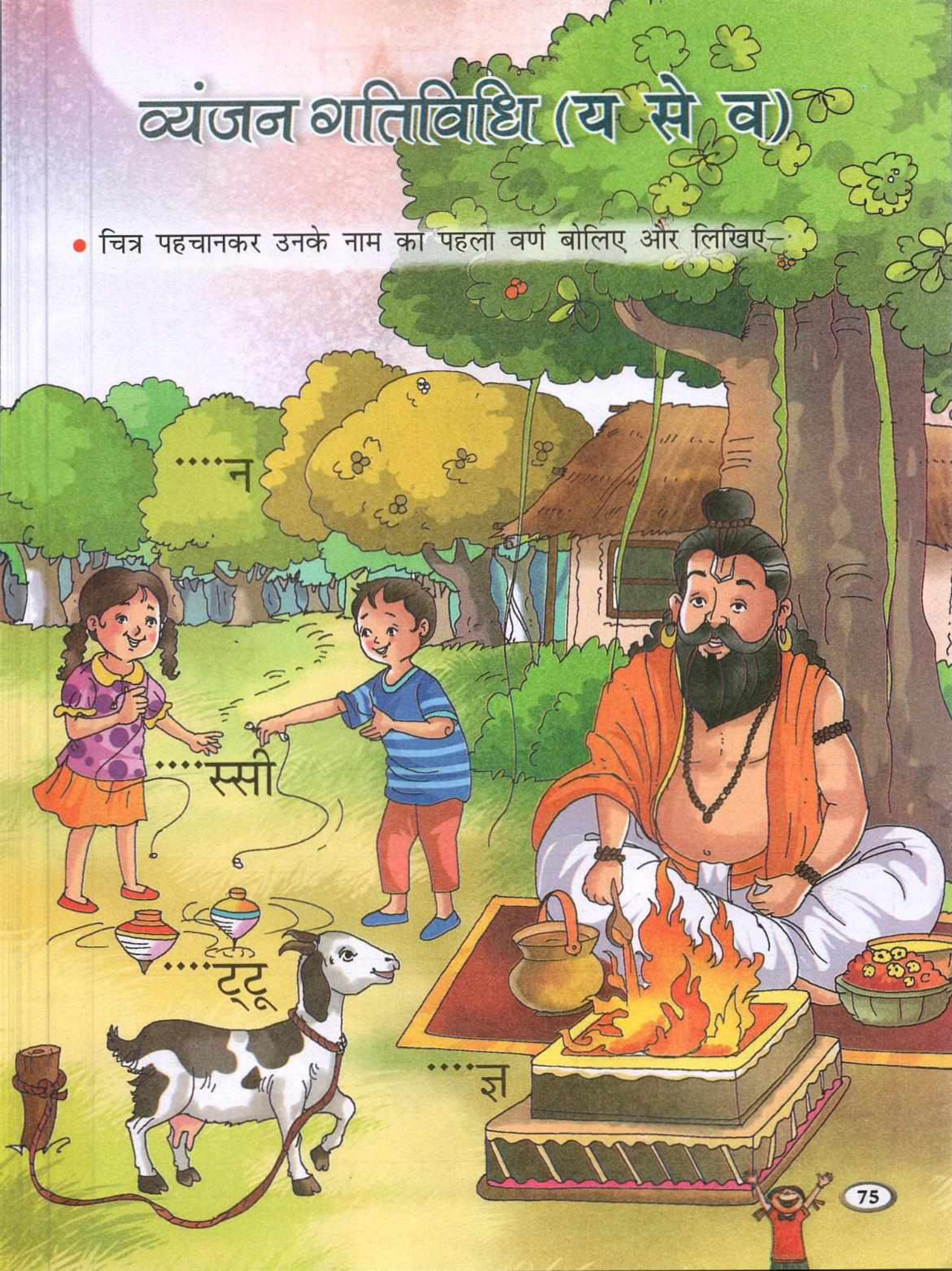

ऊष्म व्यंजन

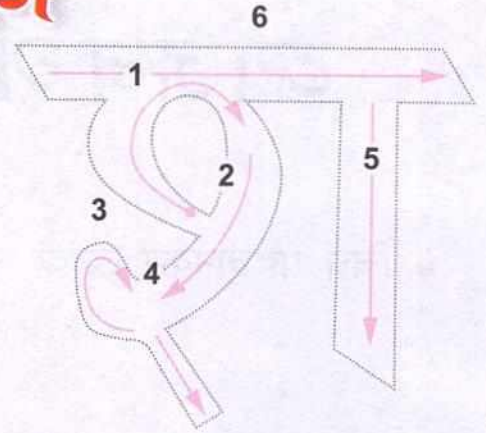

शहद
(shahad) Honey



शलगम
(shalgam) Turnip

शरबत
(sharbat) Squash

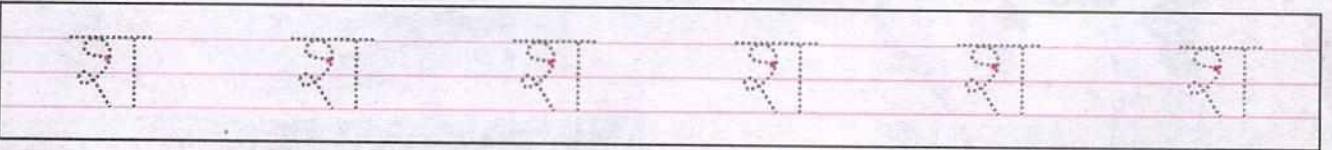
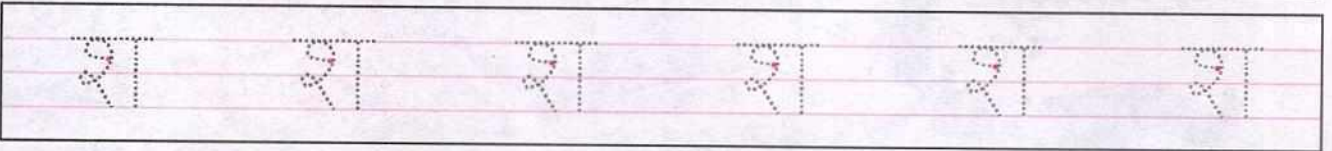
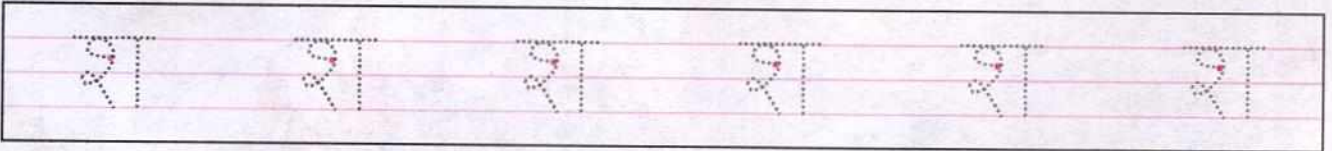
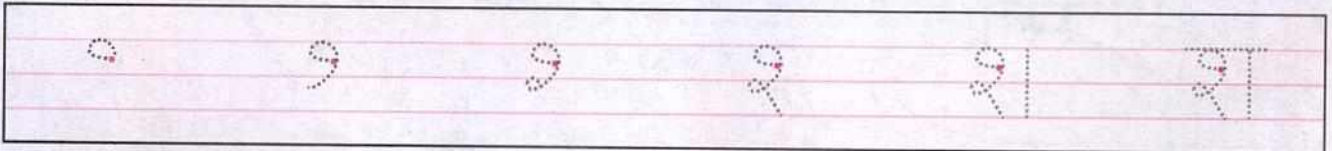

sha

ष



षट्

(shat) Six

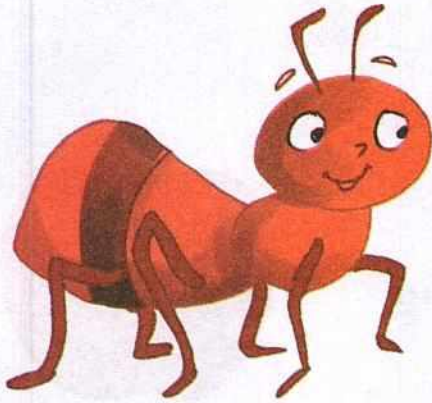
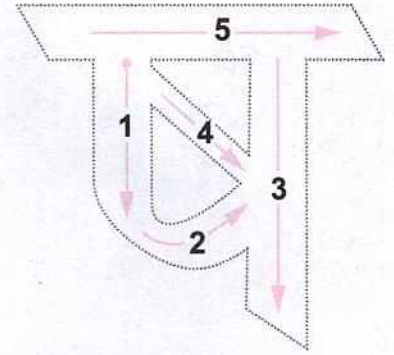

षट्पाद (चींटी)

(shatpaad) Ant

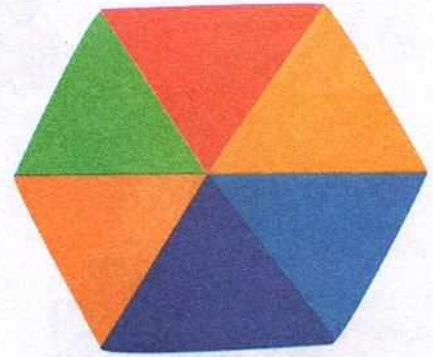

षट्कोण

(shatkon) Hexagon

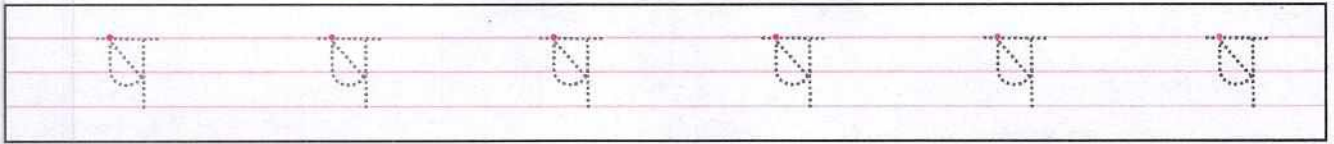
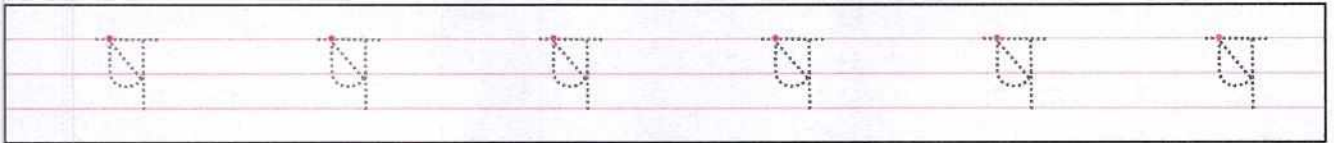
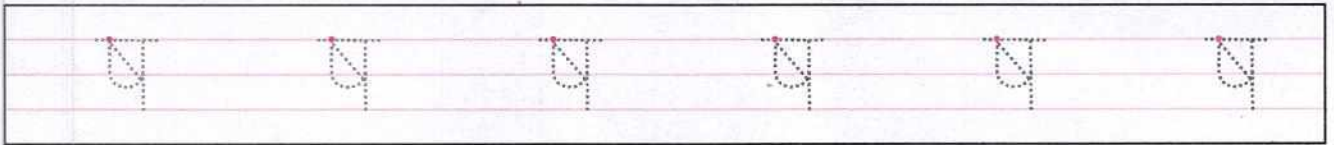
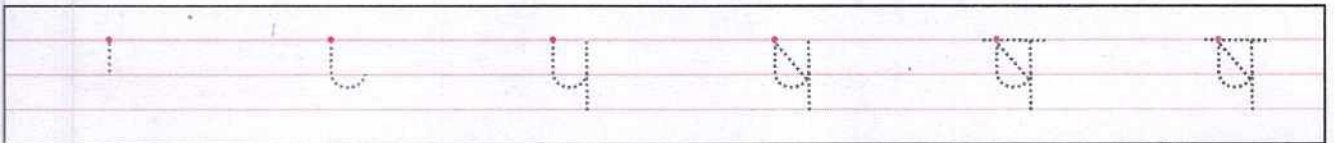

sa

स

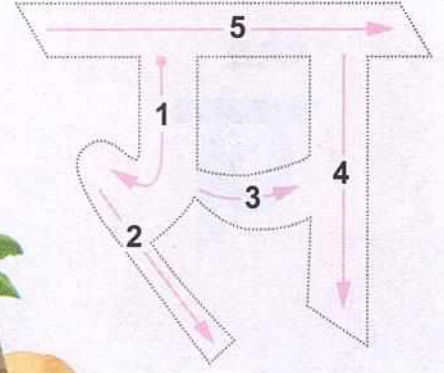

सवेरा

(savera) Morning

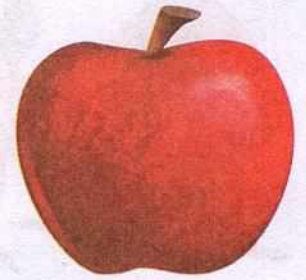

समोसा

(samosa) Samosa

सेब

(seb) Apple

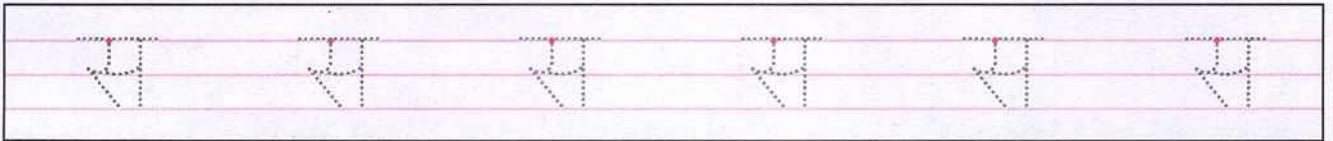
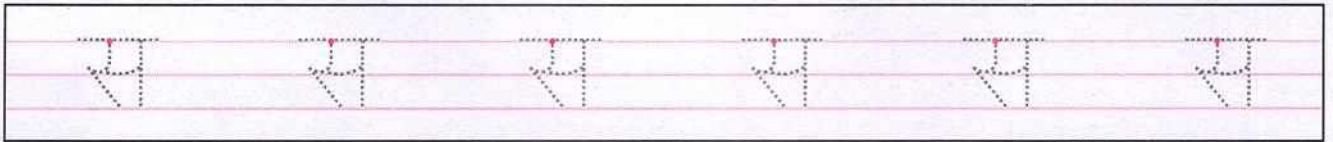
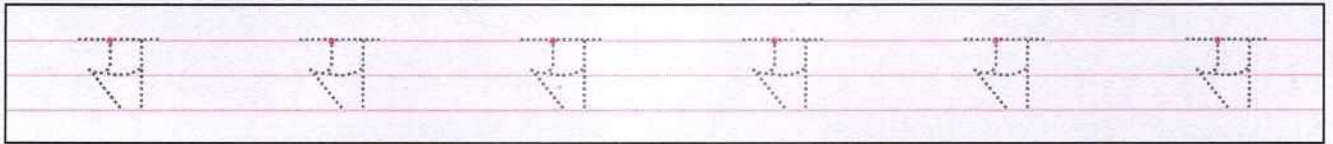
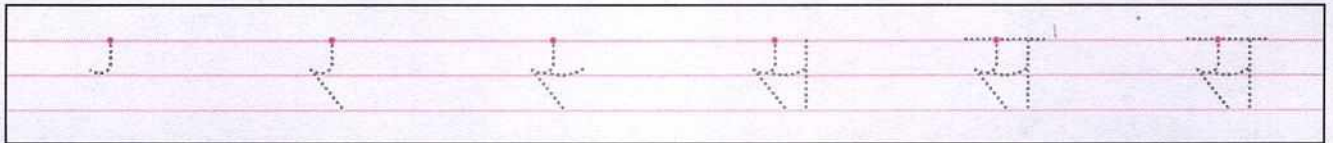

ha

ह

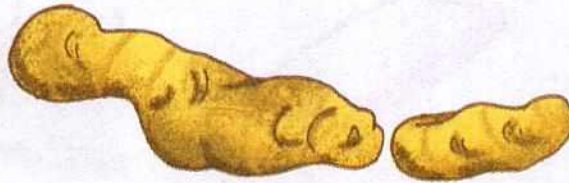
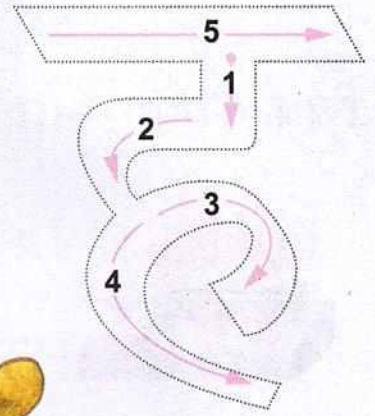

हल्दी

(haldi) Turmeric



हिरन

(hiran) Deer

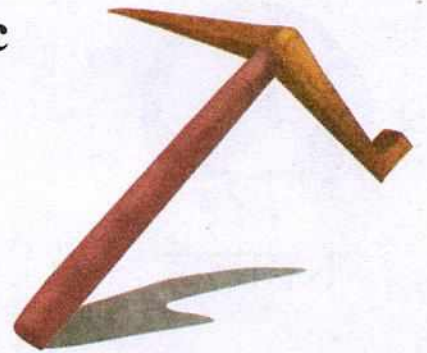

हल

(hal) Plough

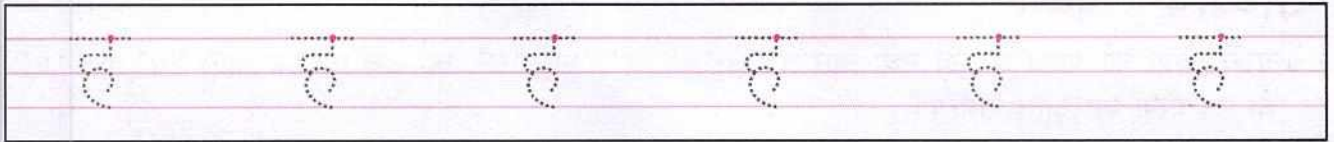
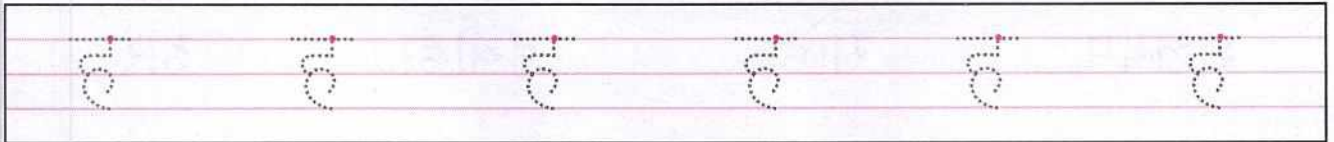
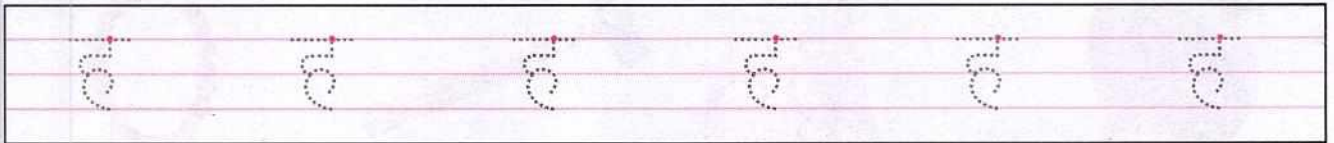
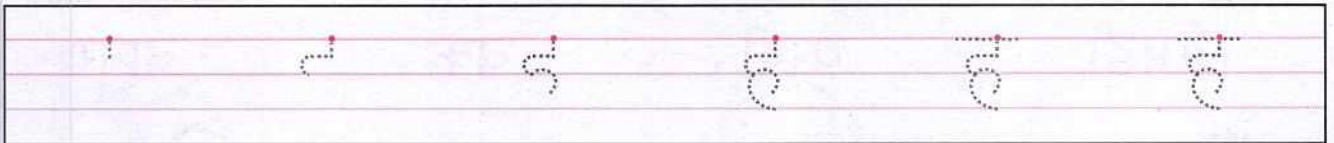

गतिविधि

चित्र देखिए और बोलिए-



यज्ञ



यंत्र



रथ



रस

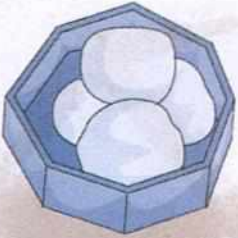

रसमलाई



लट्टू



लड़का



लुंगी



लोमड़ी



वरदी



वक



वानर



शलगम



साड़ी



हथौड़ा



हार

अध्यापन संकेत

- बच्चे चित्रों को ध्यान से देखें तथा नाम बताएँ। 'य', 'र', 'ल', 'व', का उच्चारण करवाएँ। 'श' तथा 'ष' के उच्चारण का अंतर समझाएँ।



व्यंजन गतिविधि (श से ह)

- चित्र पहचानकर उनके नाम का पहला वर्ण बोलिए और लिखिए—



संयुक्त व्यंजन

ksha

क्ष

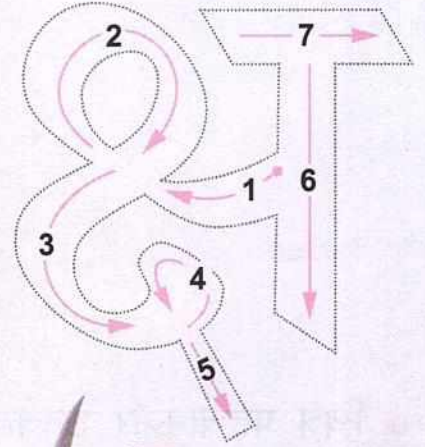

कक्ष

(kaksha) Room



पक्षी

(pakshi) Bird

क्षत्रिय

(kshatriya) Soldier

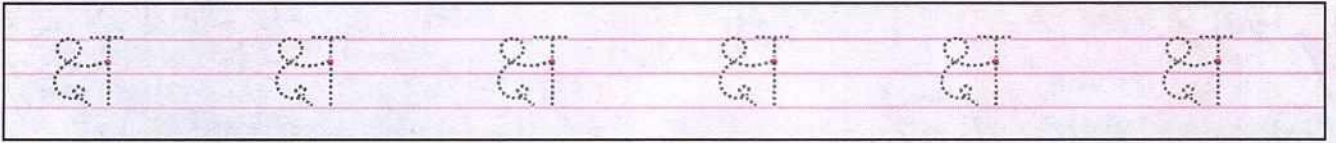
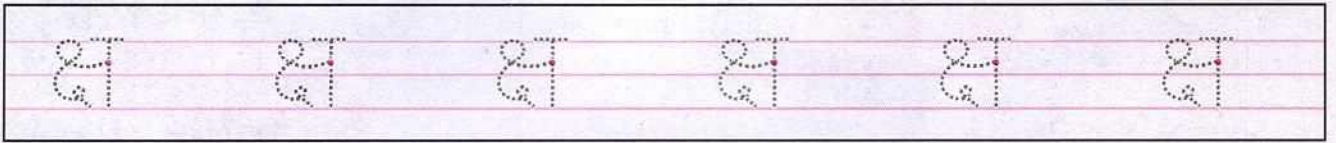
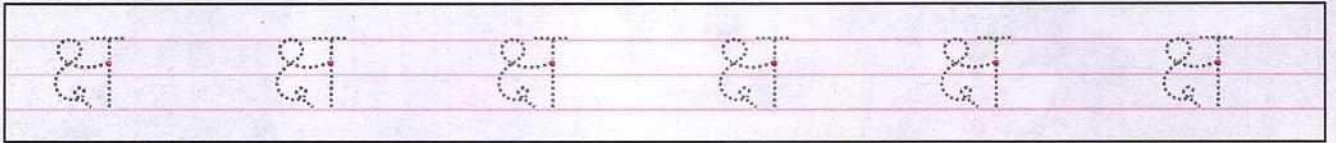
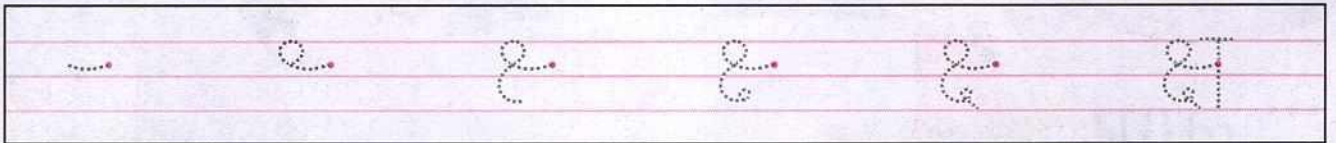

tra

त्र

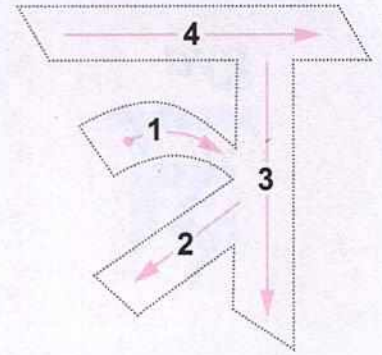

पत्र (patra)

Letter

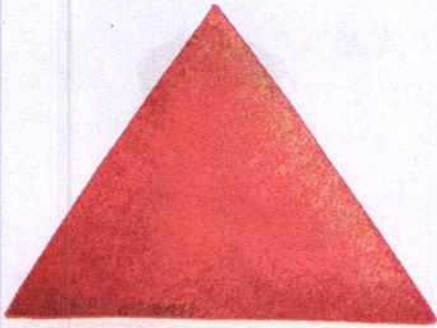

त्रिभुज

(tribhuj) Triangle



त्रिशूल

(trishool) Trident

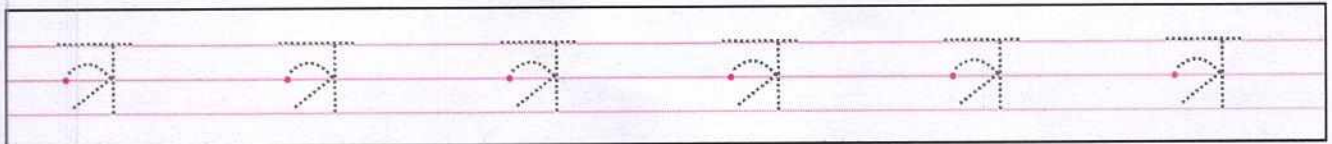
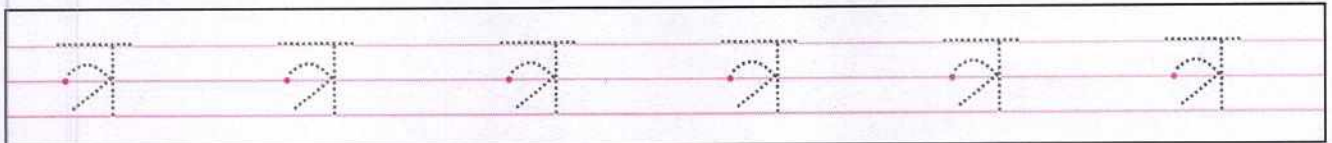
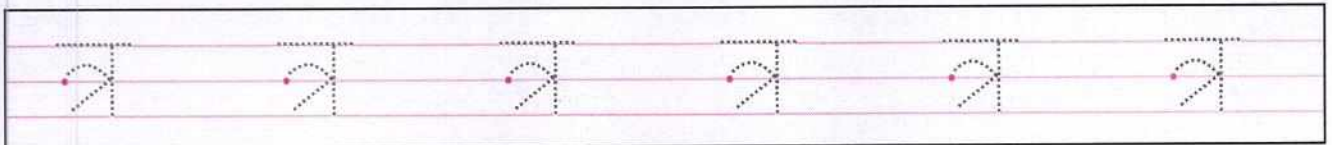
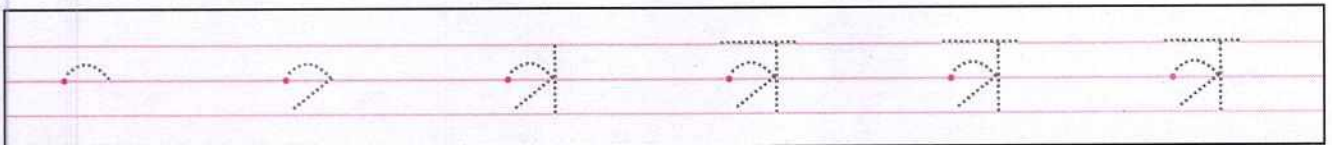

gya

ज्ञ

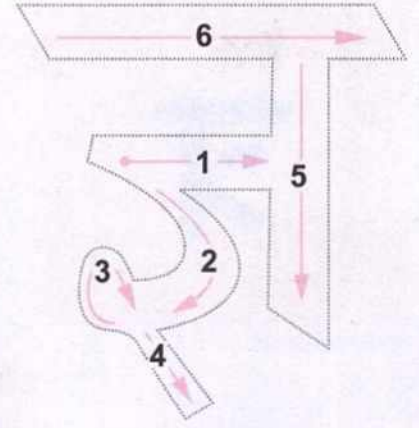

आज्ञा (agya)
Permission



ज्ञानी

(gyani) Wiseman

विज्ञान

(vigyaan) Science

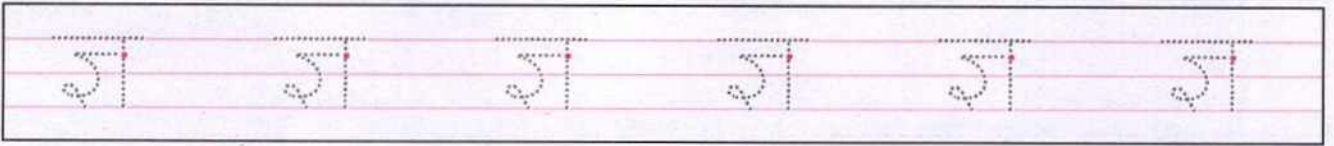
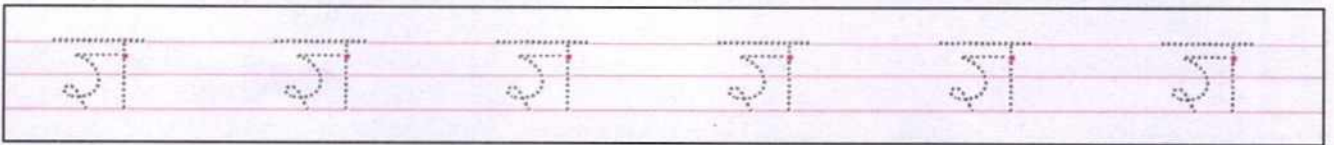
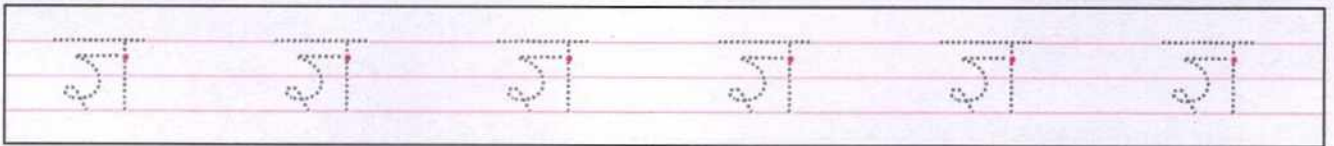
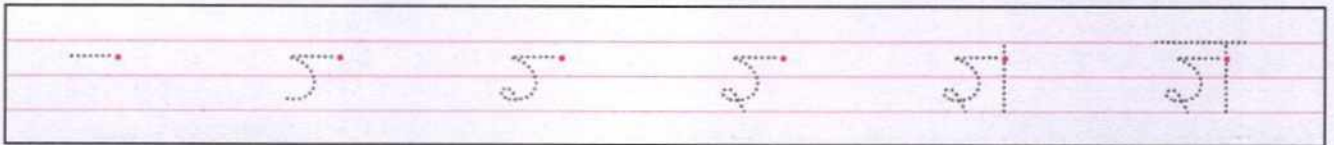

shra

श्र

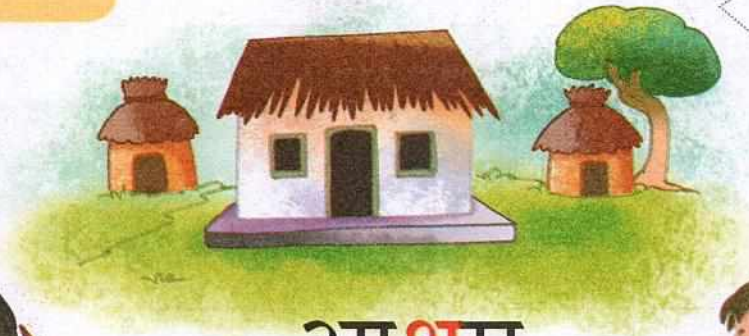
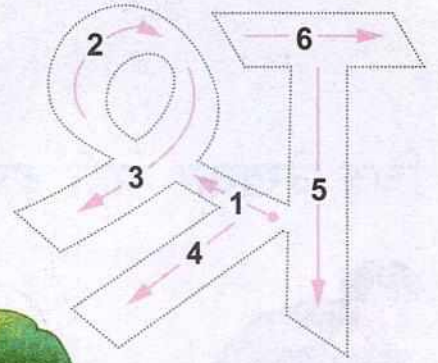

आश्रम
(aashram) Hermitage



श्रम (shram)
Hardwork



श्रमिक
(shramik) Labour

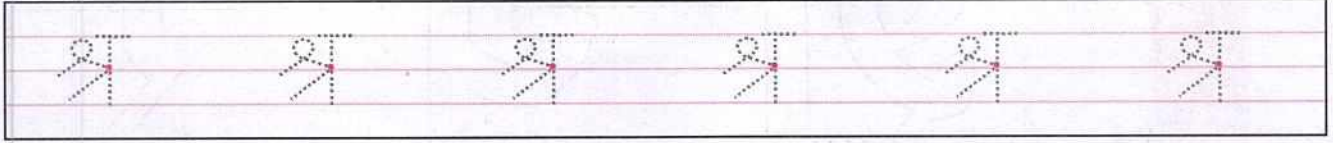
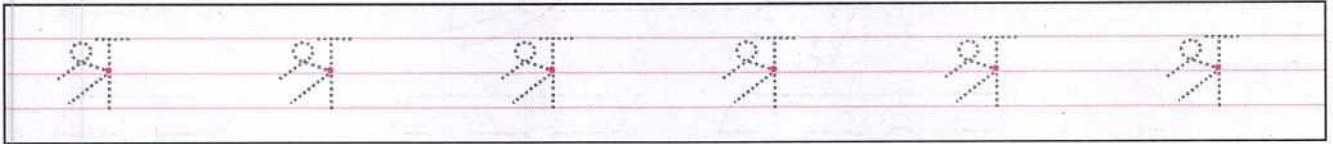
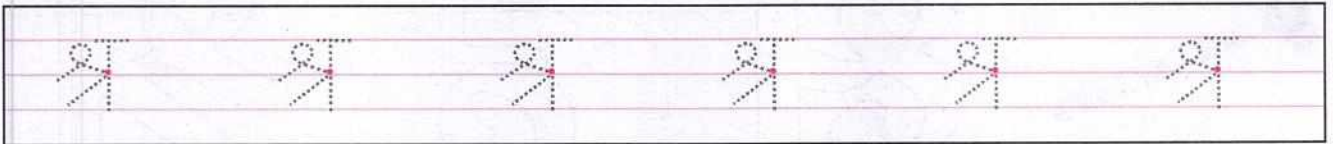
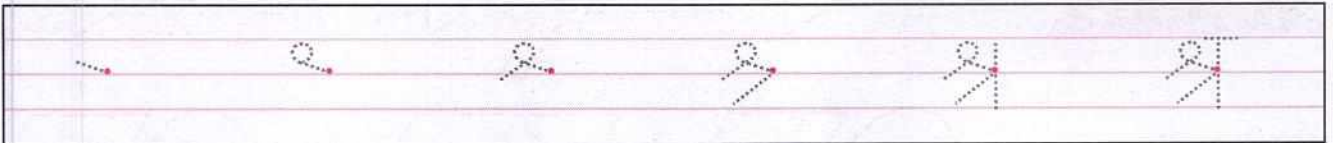

गतिविधि

चित्र देखकर सही वर्ण में रंग भरिए-



श्री ल ज्ञ



शा स ष

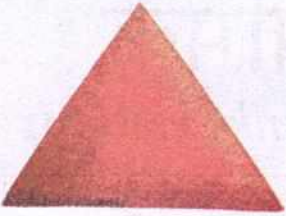

ष ज्ञ ज्ञ



क्ष ह श्री



शा य र



पुनरावृत्ति



अ



.....



इ



.....



उ



.....



ऋ



.....



ऐ



.....



औ



.....



अः



क

.....



ग



.....

ङ



.....



छ



.....



झ

.....



ट



.....



ढ



.....



ण

शिक्षण बिंदु : लय एवं हाव-भाव के साथ वर्णों को गुनगुनाएँ और बच्चों से रिक्त स्थानों में उचित वर्ण भरवाकर वर्णमाला पूरी कराएँ।





ड



ढ



.....



थ



.....



ध



.....



प



.....



ब



.....



म



.....



र



.....



व



.....



ष



.....



ह



.....

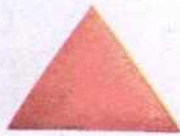

त्र



.....



श्र



बारहखड़ी

अ	आ	इ	ई	उ	ऊ	ए	ऐ	ओ	औ	अं	अः
क	का	कि	की	कु	कू	के	कै	को	कौ	कं	कः
ख	खा	खि	खी	खु	खू	खे	खै	खो	खौ	खं	खः
ग	गा	गि	गी	गु	गू	गे	गै	गो	गौ	गं	गः
घ	घा	घि	घी	घु	घू	घे	घै	घो	घौ	घं	घः
च	चा	चि	ची	चु	चू	चे	चै	चो	चौ	चं	चः
छ	छा	छि	छी	छु	छू	छे	छै	छो	छौ	छं	छः
ज	जा	जि	जी	जु	जू	जे	जै	जो	जौ	जं	जः
झ	झा	झि	झी	झु	झू	झे	झै	झो	झौ	झं	झः
ट	टा	टि	टी	टु	टू	टे	टै	टो	टौ	टं	टः
ठ	ठा	ठि	ठी	ठु	ठू	ठे	ठै	ठो	ठौ	ठं	ठः
ड	डा	डि	डी	डु	डू	डे	डै	डो	डौ	डं	डः
ढ	ढा	ढि	ढी	ढु	ढू	ढे	ढै	ढो	ढौ	ढं	ढः
ण	णा	णि	णी	णु	णू	णे	णै	णो	णौ	णं	णः
त	ता	ति	ती	तु	तू	ते	तै	तो	तौ	तं	तः
थ	था	थि	थी	थु	थू	थे	थै	थो	थौ	थं	थः
द	दा	दि	दी	दु	दू	दे	दै	दो	दौ	दं	दः
ध	धा	धि	धी	धु	धू	धे	धै	धो	धौ	धं	धः
न	ना	नि	नी	नु	नू	ने	नै	नो	नौ	नं	नः



प	पा	पि	पी	पु	पू	पे	पै	पो	पौ	पं	पः
फ	फा	फि	फी	फु	फू	फे	फै	फो	फौ	फं	फः
ब	बा	बि	बी	बु	बू	बे	बै	बो	बौ	बं	बः
भ	भा	भि	भी	भु	भू	भे	भै	भो	भौ	भं	भः
म	मा	मि	मी	मु	मू	मे	मै	मो	मौ	मं	मः
य	या	यि	यी	यु	यू	ये	यै	यो	यौ	यं	यः
र	रा	रि	री	रु	रू	रे	रै	रो	रौ	रं	रः
ल	ला	लि	ली	लु	लू	ले	लै	लो	लौ	लं	लः
व	वा	वि	वी	वु	वू	वे	वै	वो	वौ	वं	वः
श	शा	शि	शी	शु	शू	शे	शै	शो	शौ	शं	शः
ष	षा	षि	षी	षु	षू	षे	षै	षो	षौ	षं	षः
स	सा	सि	सी	सु	सू	से	सै	सो	सौ	सं	सः
ह	हा	हि	ही	हु	हू	हे	है	हो	हौ	हं	हः
क्ष	क्षा	क्षि	क्षी	क्षु	क्षू	क्षे	क्षै	क्षो	क्षौ	क्षं	क्षः
त्र	त्रा	त्रि	त्री	त्रु	त्रू	त्रे	त्रै	त्रो	त्रौ	त्रं	त्रः
ज्ञ	ज्ञा	ज्ञि	ज्ञी	ज्ञु	ज्ञू	ज्ञे	ज्ञै	ज्ञो	ज्ञौ	ज्ञं	ज्ञः
श्र	श्रा	श्रि	श्री	श्रु	श्रू	श्रे	श्रै	श्रो	श्रौ	श्रं	श्रः

अध्यापन संकेत

- विद्यार्थियों को 'क' से 'श्र' तक हर वर्ण को सही उच्चारण के साथ बारहखड़ी के अनुरूप बोलने और लिखने के लिए प्रोत्साहित करें।
- कुछ वर्णों के साथ 'ऋ' की मात्रा जोड़कर 'तेरह खड़ी' के रूप में बच्चों से बोलने और लिखने के लिए कहें।



प्यारी है बच्चों की रेल

देखो जी बच्चों के खेल,
बनी अनोखी इनकी रेल।
सबसे लंबा सबसे आगे,
इंजन बनकर फुक-फुक भागे।

सबसे छोटा सबसे पीछे,
भाग रहा है आँखें मीचे।
रेल उछलती पंजों पर,
हाथ हिला रहे फर-फर-फर।

इंजन के मुँह पर है मूँछ,
पीछे वाले के है पूँछ।

इंजन करता पूँ-पूँ-पूँ,
पूँछ बोलती कूँ-कूँ-कूँ।

छोटे-छोटे कदम बढ़ाते,
हँसते गाते दौड़े जाते।

मज़ा राजधानी का फेल
प्यारी है बच्चों की रेल।

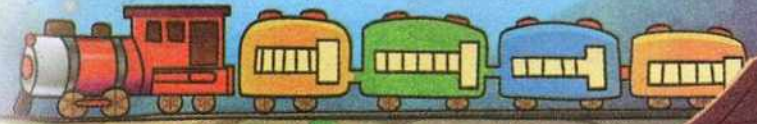

फल

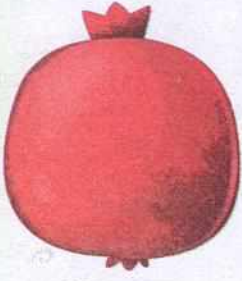

अनार



आम



अंगूर



केला



तरबूज़

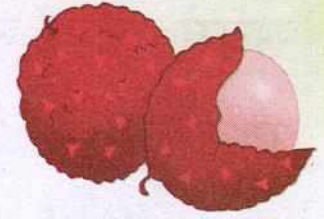

लीची



संतरा



पपीता

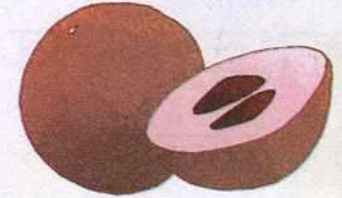

चीकू



नाशपाती



सेब



अनानास

- आपका मनपसंद फल कौन-सा है?
- फल खाने से क्या लाभ होते हैं?



सब्ज़ियाँ



गोभी



गाजर

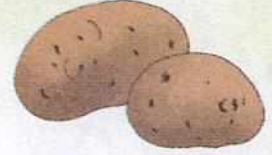

आलू



मूली



शिमला मिर्च



करेला



खीरा



बैंगन



मिर्च



मटर



शलगम

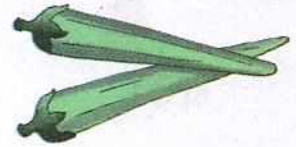

भिंडी



लौकी



पालक



कटहल

• आपकी मनपसंद सब्ज़ी कौन-सी है?



हमारे पशु



हाथी



शेर



गाय



हिरन



चूहा



लोमड़ी



बंदर



साँप



मगरमच्छ



कछुआ



याक



भालू

- आपको कौन-सा पशु अच्छा लगता है?
- आपने कौन-कौन से पशु देखे हैं?
- क्या आपने शेर देखा है?



हमारे पक्षी



तोता



गौरैया



कबूतर



चील



बाज



बया



सारस



मुर्गा



मैना



कौआ



बतख



कोयल

- तोता किस रंग का होता है?
- किस पक्षी की चोंच लंबी होती है?



गतिविधि

1. पशु-पक्षियों को उनके बच्चों से मिलाइए-



2. कौन कहाँ रहता है? मिलान कीजिए-



हमारे त्योहार



दीपावली



रक्षाबंधन



क्रिसमस



ईद



स्वतंत्रता दिवस



होली



पोंगल

- आपका मनपसंद त्योहार कौन-सा है?
- आप उसे किस प्रकार मनाते हैं?



हमारे सहायक



धोबी



कुम्हार



डाकिया



चौकीदार



दरज़ी



पुलिस



डॉक्टर



दूधवाला



सब्ज़ीवाला

● इन्हें किन चीज़ों की आवश्यकता होती है? बातचीत करें।



दिनों के नाम



सोमवार

Monday



मंगलवार

Tuesday



बुधवार

Wednesday



गुरुवार

Thursday



शुक्रवार

Friday



शनिवार

Saturday



रविवार

Sunday

- आपके विद्यालय की छुट्टी किस दिन होती है?
- आप सप्ताह में कितने दिन विद्यालय जाते हैं?



गिनती



एक, दो, तीन, चार,
आज शनि है कल इतवार।
पाँच, छह, सात, आठ
याद करूँगा सारा पाठ।



इसके आगे नौ और दस,
हो गई गिनती पूरी बस।

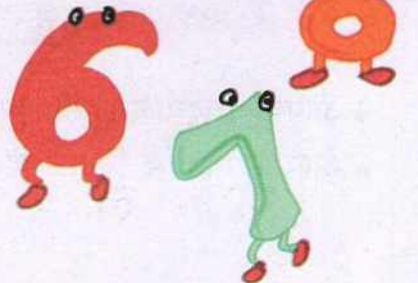

3

अमात्रिक शब्द

दो वर्णों वाले शब्द

पढ़िए और समझिए



ब + स = बस



घ + र = घर



फ + ल = फल



व + न = वन



र + थ = रथ

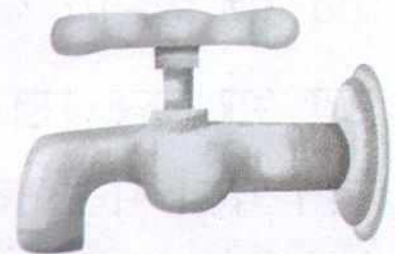

न + ल = नल



पढ़िए और बोलिए



कल	तब	मत	डर	वह	दस
फल	अब	खत	पर	रह	रस
नल	जब	छत	घर	कह	कस
जल	कब	घट	भर	तह	बस
हल	सब	नट	कर	यह	नस
थल	रब	रट	चर	सह	डस

घर चल। नल पर घट रखा।
झटपट इधर आ। फल चखा।
अब मत लड़।
रथ पर चढ़।
टब भर कर रखा।
खत पढ़। मठ तक चल
सच कहा।



अभ्यास के लिए

1. वर्ण मिलाइए, शब्द बनाइए-

न + र =

ज + ल =

क + ब =

न + थ =

घ + ट =

च + ख =

आ + म =

ह + ठ =

2. नीचे दिए गए शब्दों को उनके चित्रों से रेखा खींचकर मिलाइए-

10

टब



जग



धन



फल



दस

खत



तीन वर्णों वाले शब्द

पढ़िए और समझिए



म + ट + र = मटर



न + म + क = नमक



श + ह + द = शहद



न + ह + र = नहर

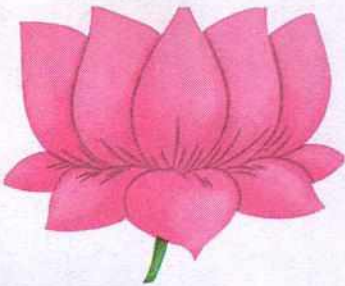

क + म + ल = कमल

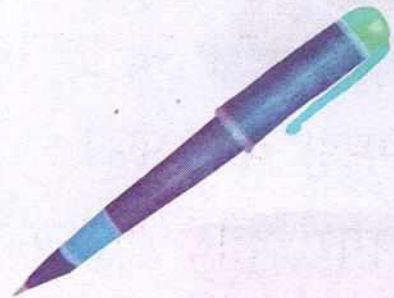

क + ल + म = कलम



पढ़िए और बोलिए

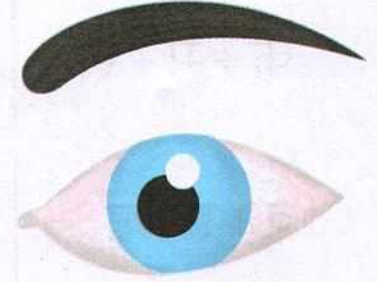

चटक	नहर	नयन	अकड़	कमल	नरम
पटक	शहर	नमन	पकड़	अकल	गरम
मटक	लहर	चमन	झगड़	शकल	चरम
भरत	झलक	सड़क	चरण	बहन	महल
परत	पलक	कड़क	करण	सहन	पहल

अमन कलम पकड़।
भरत भवन तक चल।
इधर उधर मत टहल।
नरम नरम मटर चख।
समझ कर पढ़।
अगर मगर मत कर।
कलश उधर रख।



अभ्यास के लिए

1. वर्ण मिलाइए, शब्द बनाइए-

क + म + ल =

प + क + ड़ =

ब + ह + न =

क + ल + श =

म + ग + र =

म + ह + ल =

ब + त + ख =

क + ल + म =

2. नीचे दिए गए शब्दों को उनके चित्रों से रेखा खींचकर मिलाइए-



बटन

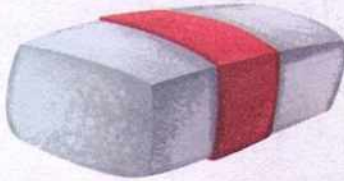

कलम



नयन

भवन



रबड़

सड़क



चार वर्णों वाले शब्द

पढ़िए और समझिए



थ + र + म + स = थरमस

ब + र + ग + द = बरगद



श + र + ब + त = शरबत

अ + च + क + न = अचकन

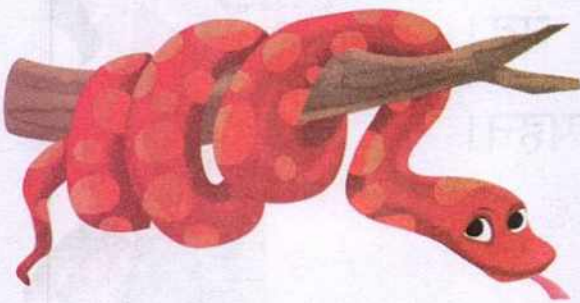

अ + ज + ग + र = अजगर

क + ट + ह + ल = कटहल



पढ़िए और बोलिए

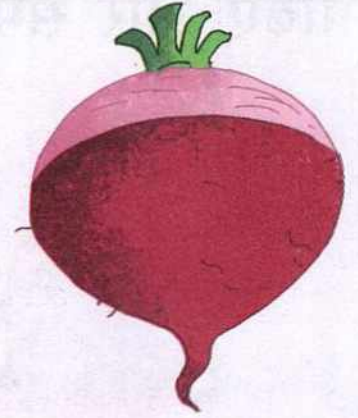

अरहर	नटखट	दमकल	धड़कन	शबनम
हलधर	झटपट	खटमल	कतरन	सरगम
अजगर	सरपट	कटहल	अचकन	शलगम
अकबर	खटखट	अटकल	बचपन	मरहम
अनपढ़	अदरक	मलमल	उलझन	थरमस
गड़बड़	तरकश	हलचल	पचपन	सरकस

शबनम चल। बरतन पकड़। थरमस रखा।
झटपट पनघट तक चल। बरगद पर चढ़।
खटखट मत कर। असलम अचकन पहन।
कसरत कर। शरबत चखा।



अभ्यास के लिए

1. वर्ण मिलाइए, शब्द बनाइए-

क + स + र + त =

म + र + ह + म =

द + म + क + ल =

त + र + क + श =

ख + ट + म + ल =

उ + प + व + न =

2. नीचे दिए गए शब्दों को उनके चित्रों से रेखा खींचकर मिलाइए-



शरबत

थरमस

बरतन

शलगम

अदरक



वर्षा शनी

वर्षा आई, वर्षा आई,
चारों ओर हरियाली छाई।
बादल गरजा, चमकी बिजली,
झूमा पत्ता, नाची डाली।
मोर नाचा झूम-झूमकर,
मेढक ने भी तान लगाई।
वर्षा आई, वर्षा आई।



ट्रैफ़िक लाइट

लाल बत्ती कहती है,
रुको भाई, रुको भाई।

पीली बत्ती ने कहा,
अब तैयार हो जाओ भाई।

हरी बत्ती कहती है,
अब देर हो गई चलो भाई।

ट्रैफ़िक बत्ती हमें समझाती
जल्दी नहीं करो भाई।

क्योंकि जल्दी में हो जाती
अकसर हमसे गलती भाई।

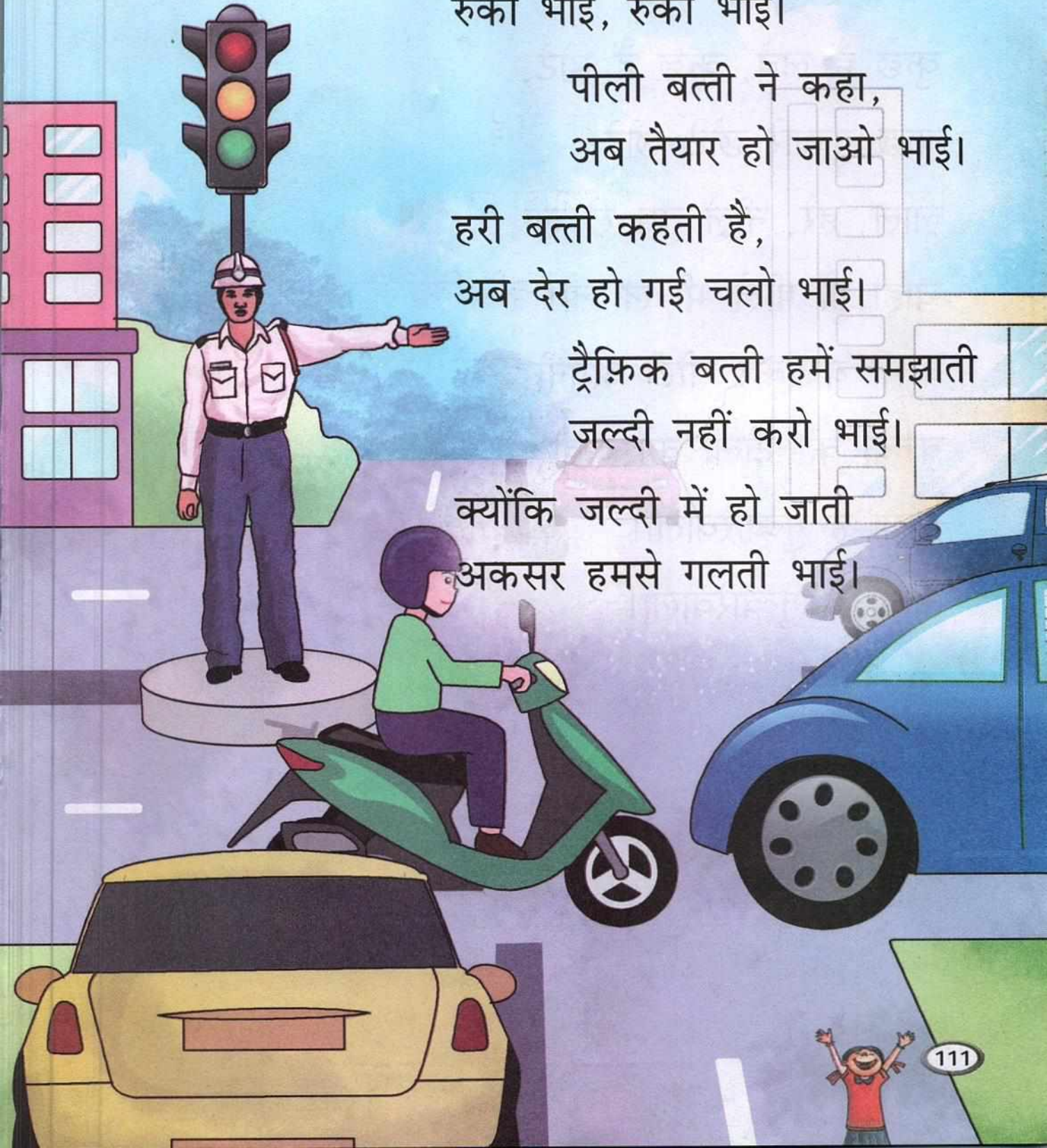

गुब्बारेवाला

गैस भरे गुब्बारे लेकर,
आया है गुब्बारेवाला।
कुछ हैं लंबे, कुछ हैं मोटे,
कुछ गुब्बारे छोटे-छोटे।
लाल, हरे, नीले तुम ले लो,
चाहो तो पीले भी ले लो।
कभी बजाकर सीटी अपनी,
बच्चों की टोली को देखो,
भाया है गुब्बारेवाला।
आया है गुब्बारेवाला।



गिनती



एक, दो, तीन, चार,
आज शनि है कल इतवार।
पाँच, छह, सात, आठ
याद करूँगा सारा पाठ।



इसके आगे नौ और दस,
हो गई गिनती पूरी बस।

