

Chapter- 2
STRUCTURE OF ATOM
LECT-1

Discovery of Electron—Discharge Tube Experiment

In 1879, William Crooks studied the conduction of electricity through gases at low pressure. He performed the experiment in a discharge tube which is a cylindrical hard glass tube about 60 cm in length. It is sealed at both the ends and fitted with two metal electrodes as shown in Fig.

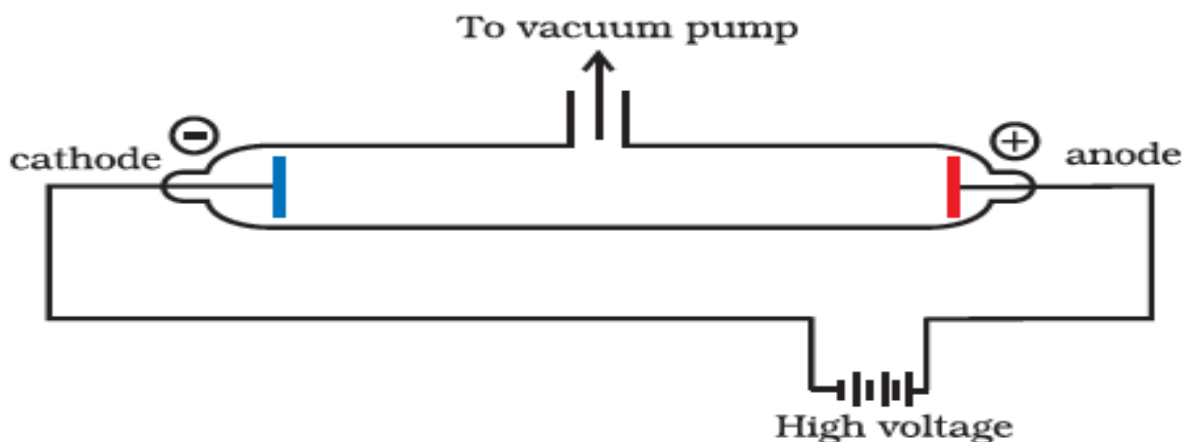

The electrical discharge through the gases could be observed only at very low pressures and at very high voltages. The pressure of different gases could be adjusted by evacuation. When sufficiently high voltage is applied across the electrodes, current starts flowing through a stream of particles moving in the tube from the negative electrode (cathode) to the positive electrode (anode). These were called cathode rays or cathode ray particles.

Properties of Cathode Rays

- (i) Cathode rays travel in straight line.
- (ii) Cathode rays start from cathode and move towards the anode.
- (iii) These rays themselves are not visible but their behaviour can be observed with the help of certain kind of materials (fluorescent or phosphorescent) which glow when hit by them.
- (iv) Cathode rays consist of negatively charged particles. When electric field is applied on the cathode rays with the help of a pair of metal plates, these are found to be deflected towards the positive plate indicating the presence of negative charge.
- (v) The characteristics of cathode rays do not depend upon the material of electrodes and the nature of gas present in the cathode ray tube.

Determination of Charge/Mass (elm) Ratio for Electrons

J. J. Thomson for the first time experimentally determined charge/mass ratio called elm ratio for the electrons. For this, he subjected the beam of electrons released in the discharge tube as cathode rays to influence the electric and magnetic fields. These were acting perpendicular to

one another as well as to the path followed by electrons.

According to Thomson, the amount of deviation of the particles from their path in presence of electric and magnetic field depends upon following factors:

- i) Greater the magnitude of the charge on the particle, greater is the interaction with the electric or magnetic field and thus greater is the deflection.
- (ii) The mass of the particle: — Lighter the particle, greater is the deflection.
- (iii) The deflection of electrons from their original path increases with the increase in the voltage across the electrodes or strength of the magnetic field. By carrying out accurate measurements on the amount of deflections observed by the electrons on the electric field strength or magnetic field strength, Thomson was able to determine the value of $e/m = 1.758820 \times 10^{11} \text{ C kg}^{-1}$ where m = Mass of the electron in kg, e = magnitude of charge on the electron in coulomb (C).

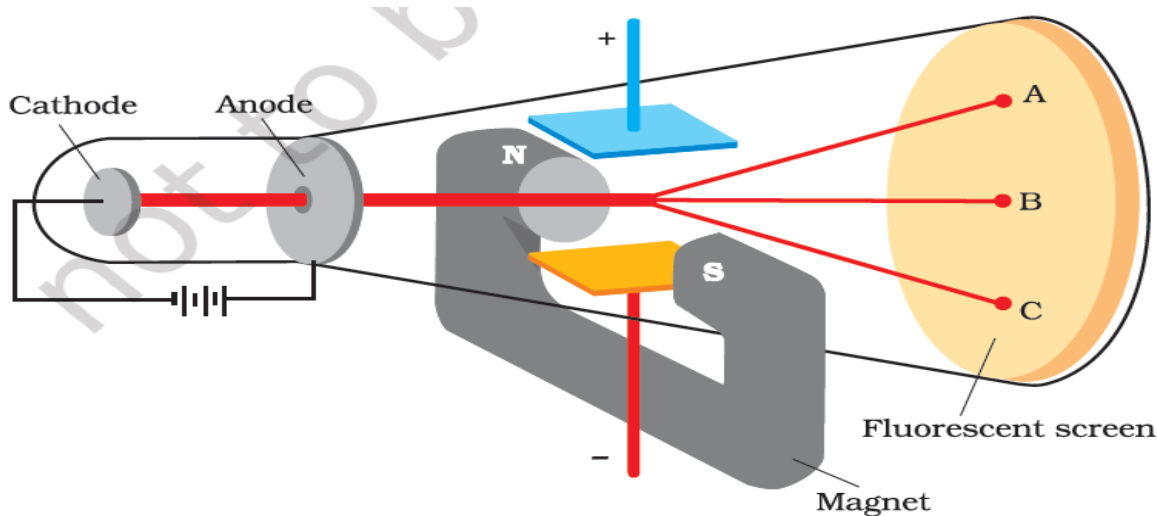

Charge on the Electron

R.A. Millikan devised a method known as oil drop experiment to determine the charge on the electrons.

$$\text{Charge of an electron } (e) = -1.6022 \times 10^{-19} \text{ C}$$

$$\begin{aligned} \text{The mass of electron } (m_e) &= \frac{e}{e/m_e} \\ &= \frac{1.6022 \times 10^{-19} \text{ C}}{1.758820 \times 10^{11} \text{ C kg}^{-1}} \\ &= 9.1094 \times 10^{-31} \text{ kg} \end{aligned}$$

Discovery of Proton—Anode Rays

In 1886; Goldstein modified the discharge tube by using a perforated cathode. On reducing the pressure, he observed a new type of luminous rays passing through the holes or perforations of the cathode and moving in a direction opposite to the cathode rays. These rays were named as

positive rays or anode rays or as canal rays. Anode rays are not emitted from the anode but from a space between anode and cathode.

Properties of Anode Rays

- (i) The value of positive charge (e) on the particles constituting anode rays depends upon the nature of the gas in the discharge tube.
- (ii) The charge to mass ratio of the particles is found to depend on the gas from which these originate.
- (iii) Some of the positively charged particles carry a multiple of the fundamental unit of electrical charge.
- (iv) The behaviour of these particles in the magnetic or electric field is opposite to that observed for electrons or cathode rays.

• Proton

The smallest and lightest positive ion was obtained from hydrogen and was called proton.

Mass of proton = 1.676×10^{-27} kg

Charge on a proton = (+) 1.602×10^{-19} C

• Neutron

it is a neutral particle. It was discovered by Chadwick (1932). By the bombardment of thin sheets of beryllium with fast moving alpha particles he observed that highly penetrating rays consist of neutral particles which were named as neutrons.

Name	Symbol	Absolute charge/C	Relative charge	Mass/kg	Mass/u	Approx. mass/u
Electron	e	-1.6022×10^{-19}	-1	9.10939×10^{-31}	0.00054	0
Proton	p	$+1.6022 \times 10^{-19}$	+1	1.67262×10^{-27}	1.00727	1
Neutron	n	0	0	1.67493×10^{-27}	1.00867	1

LECT-2

Thomson Model of Atom

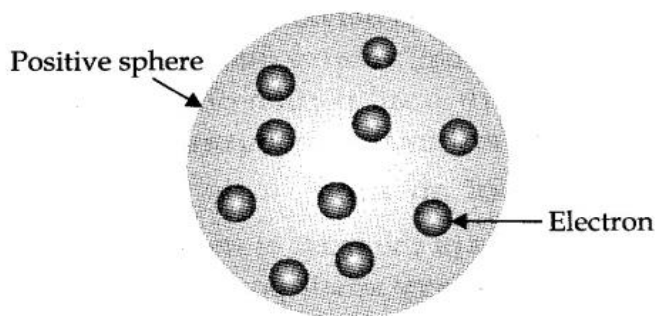

- (i) J. J. Thomson proposed that an atom may be regarded as a sphere of positive charge due to protons and in which negatively charged electrons are embedded.
- (ii) In this model, the atom is visualized as a pudding or cake of positive charge with electrons embedded into it.
- (iii) The mass of atom is considered to be evenly spread over the atom according to this model.

Drawbacks of Thomson Model of Atom:

This model was able to explain the overall neutrality of the atom, it could not satisfactorily explain the results of scattering experiments carried out by Rutherford in 1911.

Rutherford's α -particle Scattering Experiment

Rutherford in 1911, performed some scattering experiments in which he bombarded thin foils of metals like gold, silver, platinum or copper with a beam of fast moving alpha particles. The thin gold foil had a circular fluorescent zinc sulphide screen around it. Whenever alpha-particles struck the screen, a tiny flash of light was produced at that point. From these experiments, he made the following observations:

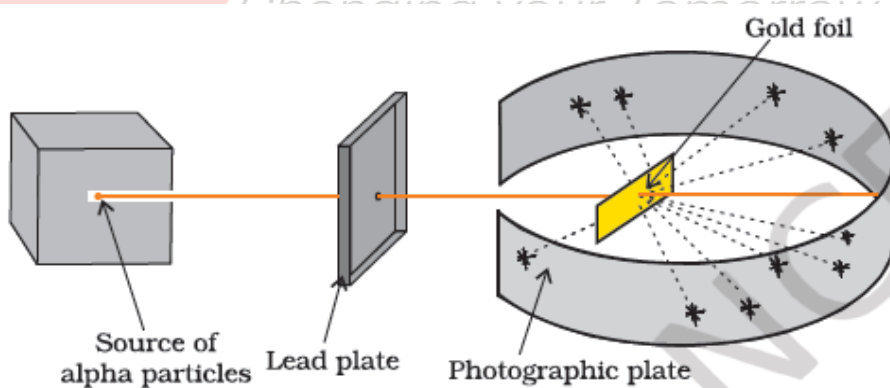

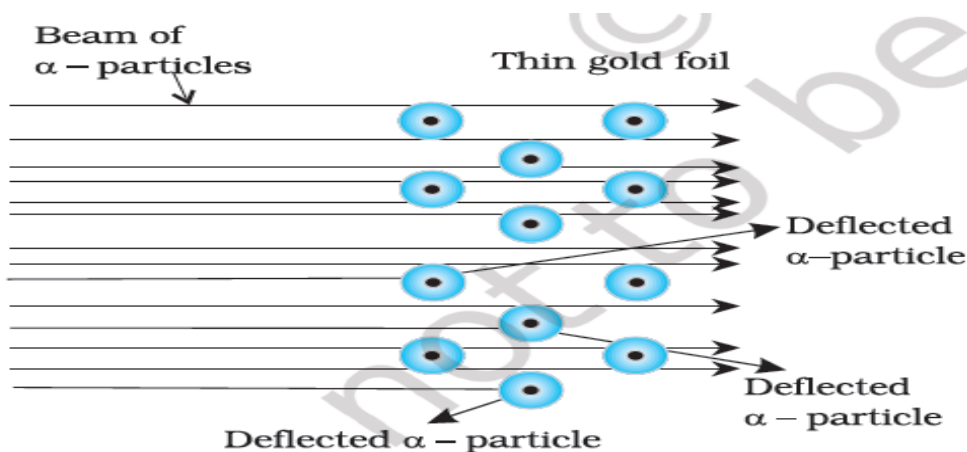

From these experiments, he made the following observations:

- (i) Most of the alpha particles passed through the foil without undergoing any deflection,
- (ii) A few α -particles underwent deflection through small angles.
- (iii) Very few were deflected back i.e., through an angle of nearly 180° .

From these observations, Rutherford drew the following conclusions:

- (i) Since most of the alpha particles passed through the foil without undergoing any deflection, there must be sufficient empty space within the atom.
- (ii) A small fraction of alpha particles was deflected by small angles. The positive charge has to be concentrated in a very small volume that repelled and deflected a few positively charged alpha particles. This very small portion of the atom was called nucleus.
- (iii) The volume of nucleus is very small as compared to total volume of atom.

• Rutherford's Nuclear Model of an Atom

- (i) The positive charge and most of the mass of the atom was densely concentrated in an extremely small region. This very small portion of the atom was called nucleus by Rutherford.
- (ii) The nucleus is surrounded by electrons that move around the nucleus with a very high speed in circular paths called orbits.
- (iii) Electrons and nucleus are held together by electrostatic forces of attraction.

• Atomic Number

The number of protons present in the nucleus is equal to the atomic number (z). For example, the number of protons in the hydrogen nucleus is 1, in sodium atom it is 11, therefore, their atomic numbers are 1 and 11. In order to keep the electrical neutrality, the number of electrons in an atom is equal to the number of protons (atomic number, z). For example, number of electrons in hydrogen atom and sodium atom are 1 and 11 respectively.

$$\begin{aligned} \text{Atomic Number } (z) &= \text{Number of protons in the nucleus of an atom.} \\ &= \text{Number of electrons in a neutral atom.} \end{aligned}$$

• Mass Number

Number of protons and neutrons present in the nucleus are collectively known as nucleons. The

total number of nucleons is termed as mass number (A) of the atom.

Mass Number (A) = Number of protons (p) + Number of neutrons (n).

• Isotopes

Atoms with identical atomic number but different atomic mass number are known as Isotopes.

Isotopes of Hydrogen:

Name of the isotope	Formula of the isotope	Mass number (A)	Number of protons (p)	Number of neutrons (n)
Protium	${}^1_1\text{H}$ (H)	1	1	0
Deuterium	${}^2_1\text{H}$ (D)	2	1	1
Tritium	${}^3_1\text{H}$ (T)	3	1	2

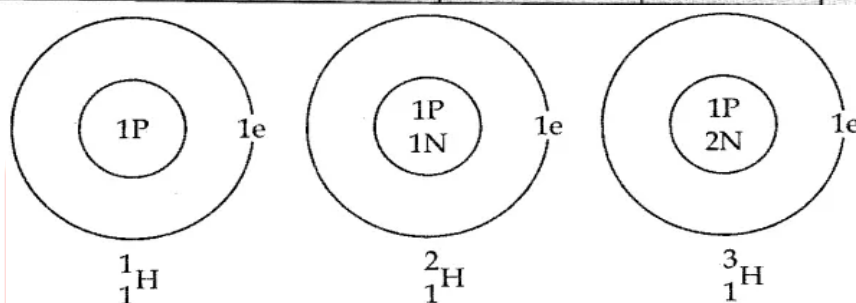

Isotopes of Chlorine: There are two isotopes of chlorine with mass numbers 35 and 37.

Formula of the isotope	Mass number (A)	Number of protons (p)	Number of neutrons (n)
${}^{35}_{17}\text{Cl}$	35	17	18
${}^{37}_{17}\text{Cl}$	37	17	20

Element	Isotopes	Element	Isotopes	Element	Isotopes
Carbon (C)	${}^{12}_6\text{C}$, ${}^{13}_6\text{C}$, ${}^{14}_6\text{C}$	Oxygen (O)	${}^{16}_8\text{O}$, ${}^{17}_8\text{O}$, ${}^{18}_8\text{O}$	Uranium	${}^{235}_{92}\text{U}$, ${}^{238}_{92}\text{U}$, ${}^{239}_{92}\text{U}$
Nitrogen (N)	${}^{14}_7\text{N}$, ${}^{15}_7\text{N}$	Chlorine (Cl)	${}^{35}_{17}\text{Cl}$, ${}^{37}_{17}\text{Cl}$	Sulphur	${}^{32}_{16}\text{S}$, ${}^{33}_{16}\text{S}$, ${}^{34}_{16}\text{S}$, ${}^{36}_{16}\text{S}$

Drawbacks of Rutherford Model

- (i) When a body is moving in an orbit, it achieves acceleration. Thus, an electron moving around nucleus in an orbit is under acceleration. According to Maxwell's electromagnetic theory, charged particles when accelerated must emit electromagnetic radiations. Therefore, an electron in an orbit will emit radiations, the energy carried by radiation comes from $h\nu$ electronic motion. Its path will become closer to nucleus and ultimately should spiral into nucleus within 10^{-8} s. But actually this does not happen.

Thus, Rutherford's model cannot explain the stability of atom if the motion of electrons is described on the basis of classical mechanics and electromagnetic theory.

- (ii) Rutherford's model does not give any idea about distribution of electrons around the nucleus and about their energies.

LECT-3

• Developments leading to the Bohr's Model of Atom

Two developments played a major role in the formulation of Bohr's model of atom. These were:

- (i) Dual character of the electromagnetic radiation which means that radiations possess both wave like and particle like properties.
- (ii) Experimental results regarding atomic spectra which can be explained only by assuming quantized electronic energy levels in atoms.

• Nature of Electromagnetic Radiation (Electromagnetic Wave Theory)

This theory was put forward by James Clark Maxwell in 1864. The main points of this theory are as follows:

- (i) The energy is emitted from any source (like the heated rod or the filament of a bulb through which electric current is passed) continuously in the form of radiations and is called the radiant energy.
- (ii) The radiations consist of electric and magnetic fields oscillating perpendicular to each other and both perpendicular to the direction of propagation of the radiation.
- (iii) The radiations possess wave character and travel with the velocity of light 3×10^8 m/sec.
- (iv) These waves do not require any material medium for propagation. For example, rays from the sun reach us through space which is a non-material medium.

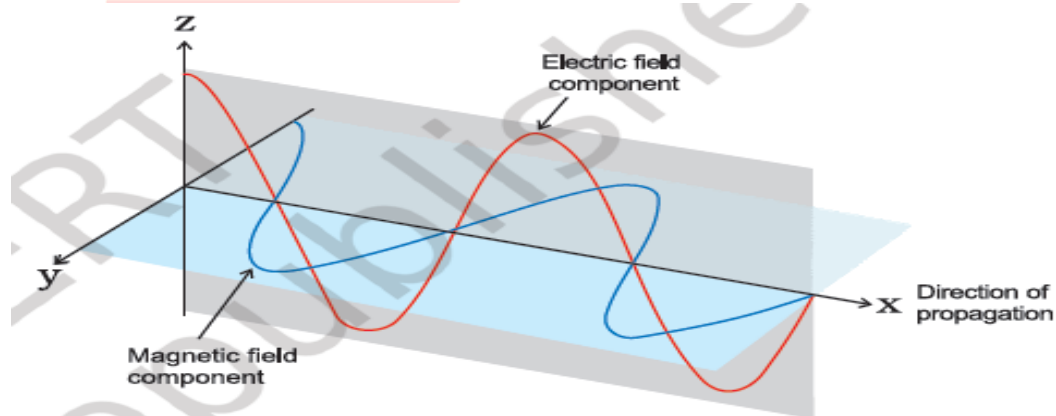

Characteristics of a Wave

Wavelength: It is defined as the distance between any two consecutive crests or troughs. It is represented by λ and its S.I. unit is metre.

$$1 \text{ \AA} = 10^{-10} \text{ m.}$$

Frequency: Frequency of a wave is defined as the number of waves passing through a point in one second. It is represented by ν (nu) and is expressed in Hertz (Hz).

$$1 \text{ Hz} = 1 \text{ cycle/sec.}$$

Velocity: Velocity of a wave is defined as the linear distance travelled by the wave in one second. It is represented by c and is expressed in cm/sec or m/sec.

Amplitude: Amplitude of a wave is the height of the crest or the depth of the trough. It is represented by V and is expressed in the units of length.

Wave Number: It is defined as the number of waves present in 1 metre length. Evidently it will be equal to the reciprocal of the wavelength. It is represented by $\bar{\nu}$ (read as nu bar).

$$\bar{\nu} = \frac{1}{\lambda}$$

Electromagnetic Spectrum: When electromagnetic radiations are arranged in order of their increasing wavelengths or decreasing frequencies, the complete spectrum obtained is called electromagnetic spectrum.

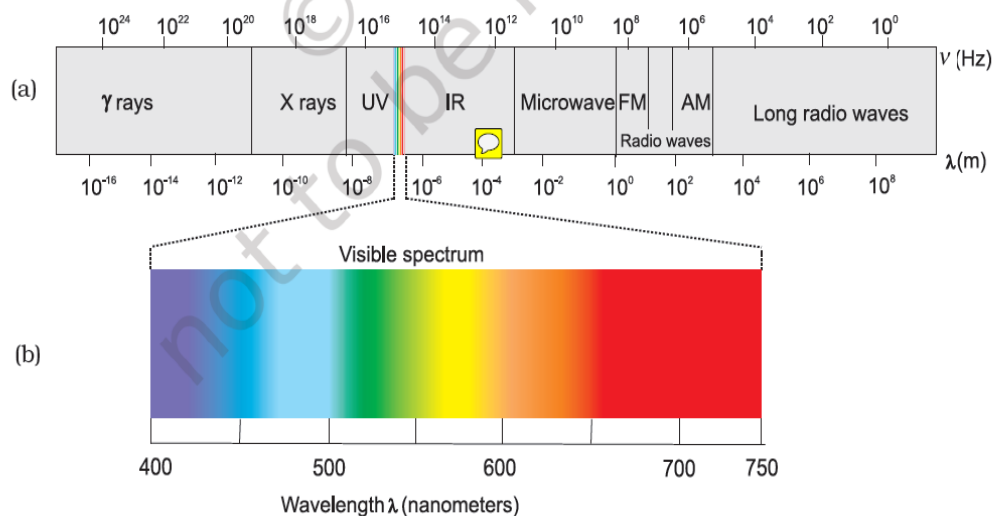

Limitations of Electromagnetic Wave Theory

Electromagnetic wave theory was successful in explaining properties of light such as interference, diffraction etc; but it could not explain the following:

- (i) The phenomenon of black body radiation.
- (ii) The photoelectric effect.
- (iii) The variation of heat capacity of solids as a function of temperature.
- (iv) The line spectra of atoms with reference to hydrogen.

• Black Body Radiation

The ideal body, which emits and absorbs all frequencies, is called a black body and the radiation

emitted by such a body is called black body radiation. The exact frequency distribution of the emitted radiation from a black body depends only on its temperature.

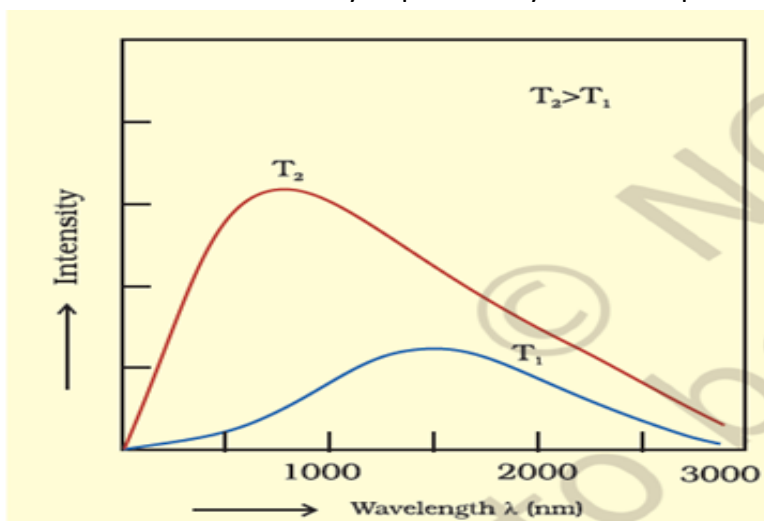

At a given temperature, intensity of radiation emitted increases with decrease of wavelength, reaches a maximum value at a given wavelength and then starts decreasing with further decrease of wavelength.

LECT-4

Planck's Quantum Theory

To explain the phenomenon of 'Black body radiation' and photoelectric effect, Max Planck in 1900, put forward a theory known as Planck's Quantum Theory.

This theory was further extended by Einstein in 1905. The main points of this theory was as follows:

- (i) The radiant energy emitted or absorbed in the form of small packets of energy. Each such packets of energy is called a quantum.
- (ii) The energy of each quantum is directly proportional to the frequency of the radiation.

i.e.,

$$E \propto \nu$$

or

$$E = h\nu$$

Where h is proportionality constant, called Planck's constant. Its value is 6.626×10^{-34} J sec.

• Photoelectric Effect

Hertz, in 1887, discovered that when a beam of light of certain frequency strikes the surface of some metals, electrons are emitted or ejected from the metal surface. The phenomenon is called photoelectric effect.

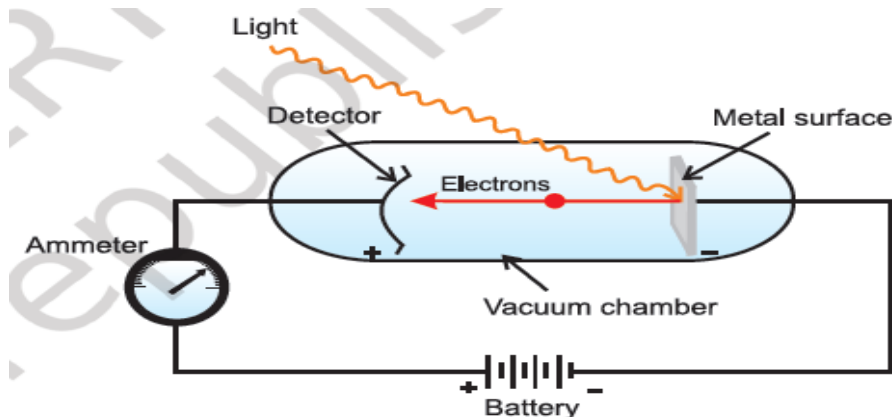

Observations in Photoelectric Effect

- (i) Only photons of light of certain minimum frequency called threshold frequency (ν_0) can cause the photoelectric effect. The value of ν_0 is different for different metals.
- (ii) The kinetic energy of the electrons which are emitted is directly proportional to the frequency of the striking photons and is quite independent of their intensity.
- (iii) The number of electrons that are ejected per second from the metal surface depends upon the intensity of the striking photons or radiations and not upon their frequency.

Explanation of Photoelectric Effect

Einstein in (1905) was able to give an explanation of the different points of the photoelectric effect using Planck's quantum theory as under:

- (i) Photoelectrons are ejected only when the incident light has a certain minimum frequency (threshold frequency ν_0)
- (ii) If the frequency of the incident light (ν) is more than the threshold frequency (ν_0), the excess energy ($h\nu - h\nu_0$) is imparted to the electron as kinetic energy. K.E. of the ejected electron.

$$\frac{1}{2}mv^2 = h\nu - h\nu_0$$

$$\text{or} \quad h\nu = h\nu_0 + \frac{1}{2}mv^2$$

$$h\nu = W_0 + \frac{1}{2}mv^2$$

- (iii) On increasing the intensity of light, more electrons are ejected but the energies of the electrons are not altered.

LECT-5

• Dual Behaviour of Electromagnetic Radiation

From the study of behaviour of light, scientists came to the conclusion that light and other electromagnetic radiations have dual nature. These are wave nature as well as particle nature. Whenever radiation interacts with matter, it displays particle like properties in contrast to the

wavelike properties (interference and diffraction) which it exhibits when it propagates. Some microscopic particles, like electrons, also exhibit this wave-particle duality.

• Spectrum

When a ray of white light is passed through a prism the wave with shorter wavelength bends more than the one with a longer wavelength. Since ordinary white light consists of waves with all the wavelengths in the visible range, array of white light is spread out into a series of coloured bands called spectrum. The light of red colour which has longest wavelength is deviated the least while the violet light, which has shortest wavelength is deviated the most.

Continuous Spectrum

When a ray of white light is analysed by passing through a prism it is observed that it splits up into seven different wide bands of colours from violet to red (like rainbow). These colours are so continuous that each of them merges into the next. Hence, the spectrum is called continuous spectrum.

Emission Spectra

Emission Spectra is noticed when the radiations emitted from a source are passed through a prism and then received on the photographic plate. Radiations can be emitted in a number of ways such as:

- (i) from sun or glowing electric bulb.
- (ii) by passing electric discharge through a gas at low pressure.
- (iii) by heating a substance to high temperature.

Line Spectra

When the vapours of some volatile substance are allowed to fall on the flame of a Bunsen burner and then analysed with the help of a spectroscope. Some specific coloured lines appear on the photographic plate which is different for different substances. For example, sodium or its salts emit yellow light while potassium or its salts give out violet light.

Absorption Spectra

When white light is passed through the vapours of a substance and the transmitted light is then allowed to strike a prism, dark lines appear. The dark lines indicate that the radiations corresponding to them were absorbed by the substance from the white light. This spectrum is called absorption spectrum.

Dark lines appear exactly at the same positions where the lines in the emission spectra appear.

• Line Spectrum of Hydrogen

When electric discharge is passed through hydrogen gas enclosed in discharge tube under low pressure and the emitted light is analysed by a spectroscope, the spectrum consists of a large number of lines which are grouped into different series. The complete spectrum is known as hydrogen spectrum.

On the basis of experimental observations, Johannes Rydberg noted that all series of lines in the hydrogen spectrum could be described by the following expression:

$$\Delta E = E_f - E_i$$

$$\Delta E = \left(-\frac{R_H}{n_f^2} \right) - \left(-\frac{R_H}{n_i^2} \right) \quad (\text{where } n_i \text{ and } n_f$$

tand for initial orbit and final orbits)

$$E = R_H \left(\frac{1}{n_i^2} - \frac{1}{n_f^2} \right) = 2.18 \times 10^{-18} \text{ J} \left(\frac{1}{n_i^2} - \frac{1}{n_f^2} \right)$$

The frequency (ν) associated with the absorption and emission of the photon can be evaluated by using equation:

$$\begin{aligned} \nu &= \frac{\Delta E}{h} = \frac{R_H}{h} \left(\frac{1}{n_i^2} - \frac{1}{n_f^2} \right) \\ &= \frac{2.18 \times 10^{-18} \text{ J}}{6.626 \times 10^{-34} \text{ J s}} \left(\frac{1}{n_i^2} - \frac{1}{n_f^2} \right) \end{aligned}$$

$$= 3.29 \times 10^{15} \left(\frac{1}{n_i^2} - \frac{1}{n_f^2} \right) \text{ Hz}$$

and in terms of wavenumbers ($\bar{\nu}$)

$$\begin{aligned} \bar{\nu} &= \frac{\nu}{c} = \frac{R_H}{hc} \left(\frac{1}{n_i^2} - \frac{1}{n_f^2} \right) \\ &= \frac{3.29 \times 10^{15} \text{ s}^{-1}}{3 \times 10^8 \text{ m s}^{-1}} \left(\frac{1}{n_i^2} - \frac{1}{n_f^2} \right) \\ &= 1.09677 \times 10^7 \left(\frac{1}{n_i^2} - \frac{1}{n_f^2} \right) \text{ m}^{-1} \end{aligned}$$

$$\bar{\nu} = 109,677 \left[\frac{1}{n_1^2} - \frac{1}{n_2^2} \right] \text{ cm}^{-1}$$

where

$$n_1 = 1, 2, \dots$$

$$n_2 = n_1 + 1, n_1 + 2, \dots$$

The value $109,677 \text{ cm}^{-1}$ is called the Rydberg constant for hydrogen.

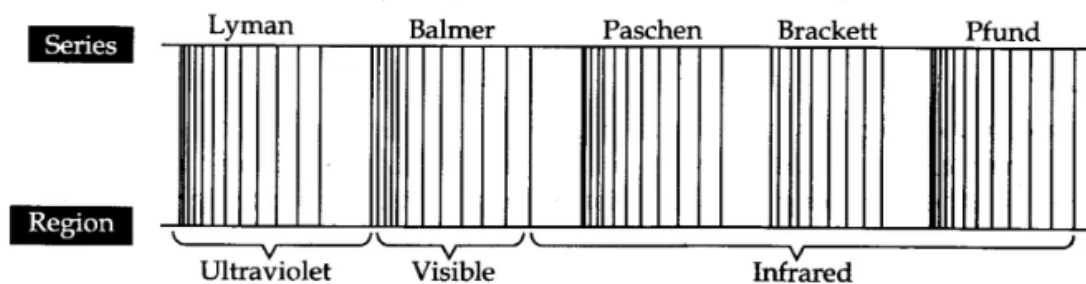

Rydberg in 1890, and has given a simple theoretical equation for the calculation of wavelengths and wave numbers of the spectral lines in different series of hydrogen spectrum. The equation is known as Rydberg formula (or equation).

$$\frac{1}{\lambda} * = \bar{\nu} = R_H \left(\frac{1}{n_1^2} - \frac{1}{n_2^2} \right)$$

This relation is valid for hydrogen atom only. For other species,

$$\frac{1}{\lambda} = \bar{\nu} = R \times Z^2 \left(\frac{1}{n_1^2} - \frac{1}{n_2^2} \right)$$

where Z is the atomic number of the species.

Here R_H = constant, called Rydberg constant for hydrogen and n_1, n_2 are integers ($n_2 > n_1$)

For any particular series, the value of n_1 is constant while that of n_2 changes. For example,

For Lyman series, $n_1 = 1, n_2 = 2, 3, 4, 5, \dots$

For Balmer series, $n_1 = 2, n_2 = 3, 4, 5, 6, \dots$

For Paschen series, $n_1 = 3, n_2 = 4, 5, 6, 7, \dots$

For Brackett series, $n_1 = 4, n_2 = 5, 6, 7, 8, \dots$

For Pfund series, $n_1 = 5, n_2 = 6, 7, 8, 9, \dots$

Thus, by substituting the values of n_1 and n_2 in the above equation, wavelengths and wave number of different spectral lines can be calculated. When $n_1 = 2$, the expression given above is called Balmer's formula.

EDUCATIONAL GROUP

Changing your Tomorrow

LECT-6

Bohr's Model of Atom

Niel Bohr in 1913, proposed a new model of atom on the basis of Planck's Quantum Theory. The main points of this model are as follows:

- (i) In an atom, the electrons revolve around the nucleus in certain definite circular paths called orbits.
- (ii) Each orbit is associated with definite energy and therefore these are known as energy levels or energy shells. These are numbered as 1, 2, 3, 4..... or K, L, M, N.....
- (iii) Only those energy orbits are permitted for the electron in which angular momentum of the electron is a whole number multiple of $h/2\pi$. Angular momentum of electron (mvr) = $nh/2\pi$ ($n = 1, 2, 3, 4$ etc).

m = mass of the electron.

v = tangential velocity of the revolving electron.

r = radius of the orbit.

h = Planck's constant.

n is an integer.

- (iv) As long as electron is present in a particular orbit, it neither absorbs nor loses energy and its energy, therefore, remains constant.
- (v) When energy is supplied to an electron, it absorbs energy only in fixed amounts as quanta and jumps to higher energy state away from the nucleus known as excited state. The excited state is unstable, the electron may jump back to the lower energy state and in doing so, and it emits the same amount of energy. ($\Delta E = E_2 - E_1$).

$$\nu = \frac{\Delta E}{h} = \frac{E_2 - E_1}{h}$$

Where E_1 and E_2 are the energies of the lower and higher allowed energy states respectively.

According to Bohr's theory for hydrogen atom:

- a) The stationary states for electron are numbered $n = 1, 2, 3, \dots$. These integral numbers are known as Principal quantum numbers.
- b) The radii of the stationary states are expressed as :

$$r_n = n^2 a_0 \quad \text{where } a_0 = 52.9 \text{ pm.}$$

Thus the radius of the first stationary state, called the Bohr orbit, is 52.9 pm.

- c) The most important property associated with the electron, is the energy of its stationary state. It is given by the expression.

$$E_n = -R_H \left(\frac{1}{n^2} \right) \quad n = 1, 2, 3, \dots$$

where R_H is called **Rydberg constant** and its value is $2.18 \times 10^{-18} \text{ J}$. The energy of the lowest state, also called as the ground state, is

$$E_1 = -2.18 \times 10^{-18} \left(\frac{1}{1^2} \right) = -2.18 \times 10^{-18} \text{ J.}$$

The energy of the stationary state for $n = 2$, will

$$\text{be : } E_2 = -2.18 \times 10^{-18} \text{ J} \left(\frac{1}{2^2} \right) = -0.545 \times 10^{-18} \text{ J.}$$

When the electron is free from the influence of nucleus, the energy is taken as zero. The electron in this situation is associated with the stationary state of Principal Quantum number = $n = \infty$ and is called as *ionized hydrogen atom*. When the electron is attracted by the nucleus and is present in orbit n , the energy is emitted and its energy is lowered. That is the reason for the presence of negative sign and depicts its stability relative to the reference state of zero energy and $n = \infty$.

d) Bohr's theory can also be applied to the ions containing only one electron, similar to that present in hydrogen atom. For example, He^+ , Li^{2+} , Be^{3+} and so on. The energies of the stationary states associated with these kinds of ions (also known as hydrogen like species) are given by the expression.

$$E_n = -2.18 \times 10^{-18} \left(\frac{Z^2}{n^2} \right) \text{ J}$$

and radii by the expression

$$r_n = \frac{52.9(n^2)}{Z} \text{ pm}$$

e) It is also possible to calculate the velocities of electrons moving in these orbits. Although the precise equation is not given here, qualitatively the magnitude of velocity of electron increases with increase of positive charge on the nucleus and decreases with increase of principal quantum number.

• Achievements of Bohr's Theory

1. Bohr's theory has explained the stability of an atom.
2. Bohr's theory has helped in calculating the energy of electron in hydrogen atom and one electron species. The mathematical expression for the energy in the n th orbit is,

$$E_n = -\frac{2\pi^2 m_e e^4 Z^2}{n^2 R^2}$$

By substituting the values of,

m_e (mass of electron)

e (charge of electron)

R (Rydberg constant)

Z (Atomic number)

The value comes out to be,

$$\begin{aligned} E_n &= -\frac{2.178 \times 10^{-18} \times Z^2}{n^2} \text{ J per atom} \\ &= -\frac{1312 \times Z^2}{n^2} \text{ kJ mol}^{-1} \end{aligned}$$

For hydrogen electron, $Z = 1$

$$\begin{aligned} E_n &= -\frac{2.178 \times 10^{-18}}{n^2} \text{ J per atom} \\ &= -\frac{1312}{n^2} \text{ kJ mol}^{-1} \end{aligned}$$

3. Bohr's theory has explained the atomic spectrum of hydrogen atom.

• **Limitations of Bohr's Model**

- (i) The theory could not explain the atomic spectra of the atoms containing more than one electron or multi electron atoms.
- (ii) In Bohr model, an electron is regarded as a charged particle moving in well defined circular orbits about the nucleus. The wave character of the electron is not considered in Bohr model.
- (iii) An orbit is a clearly defined path and this path can completely be defined only if both the position and the velocity of the electron are known exactly at the same time. This is not possible according to the Heisenberg uncertainty principle.
- (iv) Bohr model of the hydrogen atom, therefore, not only ignores dual behaviour of matter but also contradicts Heisenberg uncertainty principle.
- (v) Bohr's theory failed to explain the fine structure of the spectral lines.
- (vi) Bohr's theory could not offer any satisfactory explanation of Zeeman effect and Stark effect.
- (vii) Bohr's theory failed to explain the ability of atoms to form molecule formed by chemical bonds.

LECT-7

Dual Behaviour of Matter (de Broglie Equation)

de Broglie in 1924, proposed that matter, like radiation, should also exhibit dual behaviour i.e., both particle like and wave like properties. This means that like photons, electrons also have momentum as well as wavelength. From this analogy, de Broglie gave the following relation between wavelength (λ) and momentum (p) of a material particle.

$$\lambda = \frac{h}{mv} = \frac{h}{P}$$

where

m = mass of the particle
 v = velocity of particle
 P = momentum of the particle

This relationship has been verified by an experiment.

de-Broglie wavelength is significant only for microscopic objects and is negligible for macroscopic objects.

• Heisenberg's Uncertainty Principle

It states that, "It is impossible to determine simultaneously, the exact position and exact momentum (or velocity) of an electron".

Mathematically, it can be given as,

$$\Delta x \times \Delta P_x \geq \frac{h}{4\pi}$$

or $\Delta x \times \Delta (mv_x) \geq \frac{h}{4\pi}$

or $\Delta x \times \Delta v_x \geq \frac{h}{4\pi m}$

where Δx is the uncertainty in position and ΔP_x (or ΔV_x) is the uncertainty in momentum (or velocity) of the particle and h is Planck's constant.

Significance of Uncertainty Principle

- (i) It rules out existence of definite paths or trajectories of electrons and other similar particles.
- (ii) The effect of Heisenberg's uncertainty principle is significant only for microscopic objects and is negligible for macroscopic objects.

• Quantum Mechanical Model of Atom

Quantum mechanics: Quantum mechanics is a theoretical science that deals with the study of the motions of the microscopic objects that have both observable wave like and particle like properties.

Important Features of Quantum Mechanical Model of Atom

- (i) The energy of electrons in atom is quantized i.e., can only have certain values.
- (ii) The existence of quantized electronic energy level is a direct result of the wave like properties of electrons.

Quantum mechanics was developed independently in 1926 by Werner Heisenberg and Erwin Schrödinger which is based on the ideas of wave motion. The fundamental equation of quantum mechanics was developed by Schrödinger as:

$$\frac{\partial^2 \psi}{\partial x^2} + \frac{\partial^2 \psi}{\partial y^2} + \frac{\partial^2 \psi}{\partial z^2} + \frac{8\pi^2 m}{h^2} (E - V) \psi = 0$$

Second derivative with respect to Z Schrodinger wave Function
 Position Energy Potential Energy

Where ψ = Amplitude of the wave, x, y and z = Coordinates of the electron.

E = Total energy of the electron, V = Potential energy

M = Mass of electron, h = Planck's constant.

$$\frac{\partial^2 \Psi}{\partial x^2} = \text{Second derivative of } \Psi \text{ with respect to } x \text{ and so on}$$

In short Schrodinger wave equation is written as

$$\hat{H}\Psi = E\Psi$$

\hat{H} = Mathematical operator, called Hamiltonian operator

The solution of Schrodinger wave equation for an electron gives the value of ψ and E .

When Schrödinger equation is solved for hydrogen atom, the solution gives the possible energy levels the electron can occupy and the corresponding wave function (ψ) of the electron associated with each energy level. These quantized energy states and corresponding wave functions which are characterized by a set of three quantum numbers.

The wave function is a mathematical function whose value depends upon the coordinates of the electron in the atom.

Significance of wave function ψ and its Squared value ψ^2

The wave function ψ for an electron in an atom is the amplitude of wave. The square of wave function or amplitude of wave at any point gives the intensity of sound or light at that point. So ψ^2 of electron at any point gives the intensity of electron wave at that point. Thus ψ^2 at any point gives the probability of finding of electron at that point i.e electron density at that point. Hence the three dimensional space around the nucleus where the probability of finding of electron is maximum is known as **atomic orbital**.

The probability of finding electron at a point within an atom is proportional to square of orbital wave function i.e., $|\psi|^2$ at that point. It is known as probability density and is always positive. From the value of $|\psi|^2$ at different points within atom, it is possible to predict the region around the nucleus where electron most probably will be found.

LECT-8

Quantum Numbers

Atomic orbitals can be specified by giving their corresponding energies and angular momentum which are quantized (i.e., they have specific values). The quantized values can be expressed in terms of quantum numbers. These are used to get complete information about electron i.e., its location, energy, spin etc.

Principal Quantum Number (n)

It is the most important quantum number since it tells the principal energy level or shell to which the electron belongs. It is denoted by the letter n and can have any integral value except zero,

i.e., $n = 1, 2, 3, 4, \dots$ etc. The various principal energy shells are also designated by the letters, K, L, M, N, O, P etc. starting from the nucleus.

The principal quantum number gives us the following information:

- (i) It gives the average distance of the electron from the nucleus.
- (ii) It completely determines the energy of the electron in hydrogen atom and hydrogen like particles.
- (iii) The maximum number of electrons present in any principal shell is given by $2n^2$ where n is the number of the principal shell.

Azimuthal or Subsidiary or Orbital Angular Quantum Number (l)

It is found that the spectra of the elements contain not only the main lines but there are many fine lines also present. This number helps to explain the fine lines of the spectrum.

The azimuthal quantum number gives the following information:

- (i) The number of sub shells present in the main shell.
- (ii) The angular momentum of the electron present in any subshell.
- (iii) The relative energies of various sub shells.
- (iv) The shapes of the various sub shells present within the same principal shell.

This quantum number is denoted by the letter l. For a given value of n, it can have any value ranging from 0 to $n - 1$. For example: For the 1st shell (k), $n = 1$, l can have only one value i.e., $l = 0$. For $n = 2$, the possible value of l can be 0 and 1. Sub shells corresponding to different values of l are represented by the following symbols:

value of $l = 0 \ 1 \ 2 \ 3 \ 4 \ 5 \dots\dots\dots$

Notation for sub shell are s p d f g h

Magnetic Orbital Quantum Number (m or m_l)

The magnetic orbital quantum number determines the number of preferred orientations of the

electrons present in a sub shell. Since each orientation corresponds to an orbital, therefore, the magnetic orbital quantum number determines the number of orbitals present in any sub shell. The magnetic quantum number is denoted by letter m or m_l and for a given value of l , it can have all the values ranging from $-l$ to $+l$ including zero. Thus, for energy value of l , m has $2l + 1$ values.

For example:

For $l = 0$ (s-sub shell), m_l can have only one value i.e., $m_l = 0$. This means that s-sub shell has only one orientation in space. In other words, s-sub shell has only one orbital called s-orbital.

Spin Quantum Number (S or m_s)

All these quantum numbers are not enough to explain the line spectra observed in the case of multi-electron atoms, that is, some of the lines actually occur in doublets (two lines closely spaced), triplets (three lines, closely spaced) etc. This suggests the presence of a few more energy levels than predicted by the three quantum numbers. In 1925, George Uhlenbeck and Samuel Goudsmit proposed the presence of the fourth quantum number known as the electron spin quantum number (m_s).

An electron spins around its own axis, much in a similar way as earth spins around its own axis while revolving around the sun. This quantum number helps to explain the magnetic properties of the substances. A spinning electron behaves like a micro magnet with a definite magnetic moment. If an orbital contains two electrons, the two magnetic moments oppose and cancel each other.

An electron has, besides charge and mass, intrinsic spin angular quantum number. Spin angular momentum of the electron is a vector quantity, can have two orientations relative to the chosen axis. These two orientations are distinguished by the spin quantum numbers m_s which can take the values of $+\frac{1}{2}$ or $-\frac{1}{2}$.

The $+\frac{1}{2}$ or $-\frac{1}{2}$ are called the two spin states of the electron and are normally represented by two arrows, \uparrow (spin up) and \downarrow (spin down). Two electrons that have different m_s values (one $+\frac{1}{2}$ and the other $-\frac{1}{2}$) are said to have opposite spins. An orbital cannot hold more than two electrons and these two electrons should have opposite spins.

LECT-9

Shapes of s-orbitals:

s-orbital is present in the s-sub shell. For this sub shell, $l = 0$ and $m_l = 0$. Thus, s-orbital with only one orientation has a spherical shape with uniform electron density along all the three axes. The probability of 1s electron is found to be maximum near the nucleus and decreases with the increase in the distance from the nucleus. In 2s electron, the probability is also maximum near the nucleus and decreases to zero probability. The spherical empty shell for 2s electron is called nodal surface or simply node. It may be noted that for 1s orbital the probability density is maximum at the nucleus and it decreases sharply as we move away from it. On the other hand, for 2s orbital the probability density first decreases sharply to zero and again starts increasing. After reaching a small maxima it decreases again and approaches zero as the value of r increases further. The region where this probability density function reduces to zero is called nodal surfaces or simply nodes. In general, it has been found that ns-orbital has $(n - 1)$ nodes, that is, number of nodes increases with increase of principal quantum number n . In other words, number of nodes for 2s orbital is one, two for 3s and so on.

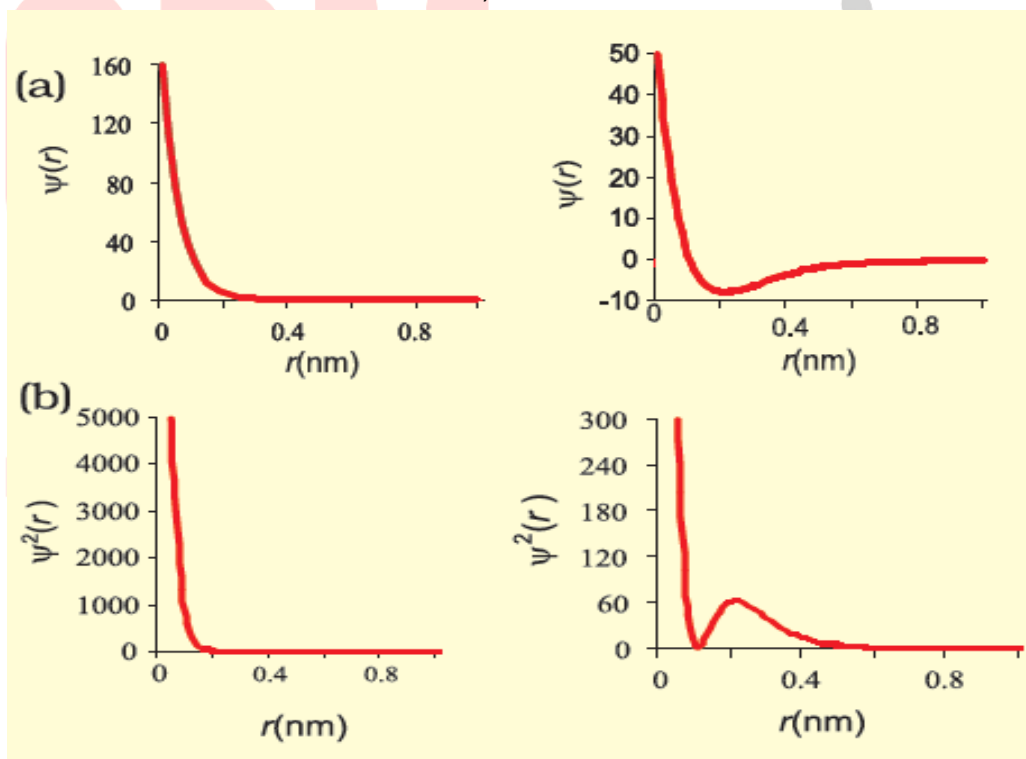

Boundary surface diagrams of constant probability density for different orbitals give a fairly good representation of the shapes of the orbitals.

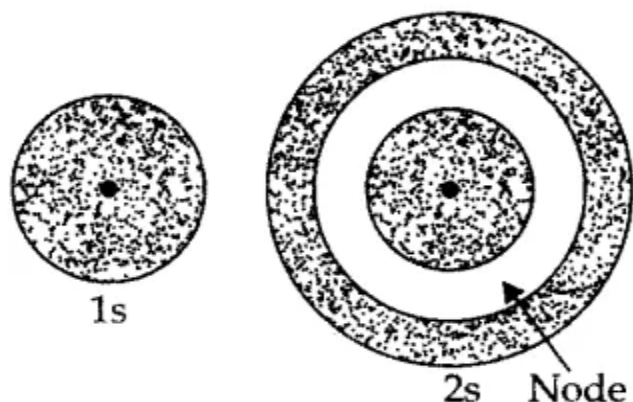

1s and 2s orbitals are spherical in shape. In reality all the s-orbitals are spherically symmetric, that is, the probability of finding the electron at a given distance is equal in all the directions. It is also observed that the size of the s orbital increases with increase in n , that is, $4s > 3s > 2s > 1s$ and the electron is located further away from the nucleus as the principal quantum number increases.

Shapes of p-orbitals

p-orbitals are present in the p-sub shell for which $l = 1$ and m_l can have three possible orientations $-1, 0, +1$. Thus, there are three orbitals in the p-sub shell which are designated as p_x, p_y and p_z orbitals depending upon the axis along which they are directed. The general shape of a p-orbital is dumb-bell consisting of two portions known as lobes. Moreover, there is a plane passing through the nucleus along which finding of the electron density is almost nil. This is known as nodal plane as shown in the fig

Boundary surface diagrams for 2p orbitals

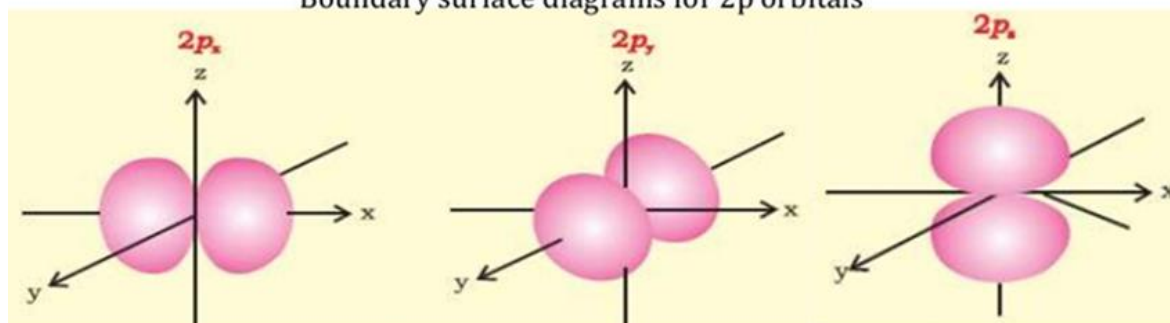

Each p-orbital consists of two sections called lobes that are on either side of the plane that passes through the nucleus. The probability density function is zero on the plane where the two lobes touch each other. The number of nodes are given by the $n - 2$, that is number of radial node is 1 for 3p orbital, two for 4p orbital and so on. The order of the energy and size of various p-orbitals is $4p > 3p > 2p$. The number of nodes are given by the $n - 2$, that is number of radial node is 1 for 3p orbital, two for 4p orbital and so on.

From the dumb-bell pictures, it is quite obvious that unlike s-orbital, a p-orbital is directional in nature. The size, shape and energy of the three orbitals are identical.

• Shapes of d-orbitals

d-orbitals are present in d-sub shell for which $l = 2$ and $m_l = -2, -1, 0, +1$ and $+2$. This means that there are five orientations leading to five different orbitals.

These five orientations are designated as d_{xy} , d_{yz} , d_{zx} , $d_{x^2-y^2}$ and d_{z^2} . However, they have the same energy i.e., are in degeneracy state and are known as degenerate orbitals. The first three orbitals have clover leaf shape and lie in different planes which are xy , yz and zx planes respectively. The $d_{x^2-y^2}$ orbital is also clover leaf shaped but its lobes are directed along the X and Y-axis.

Shape of d-orbitals

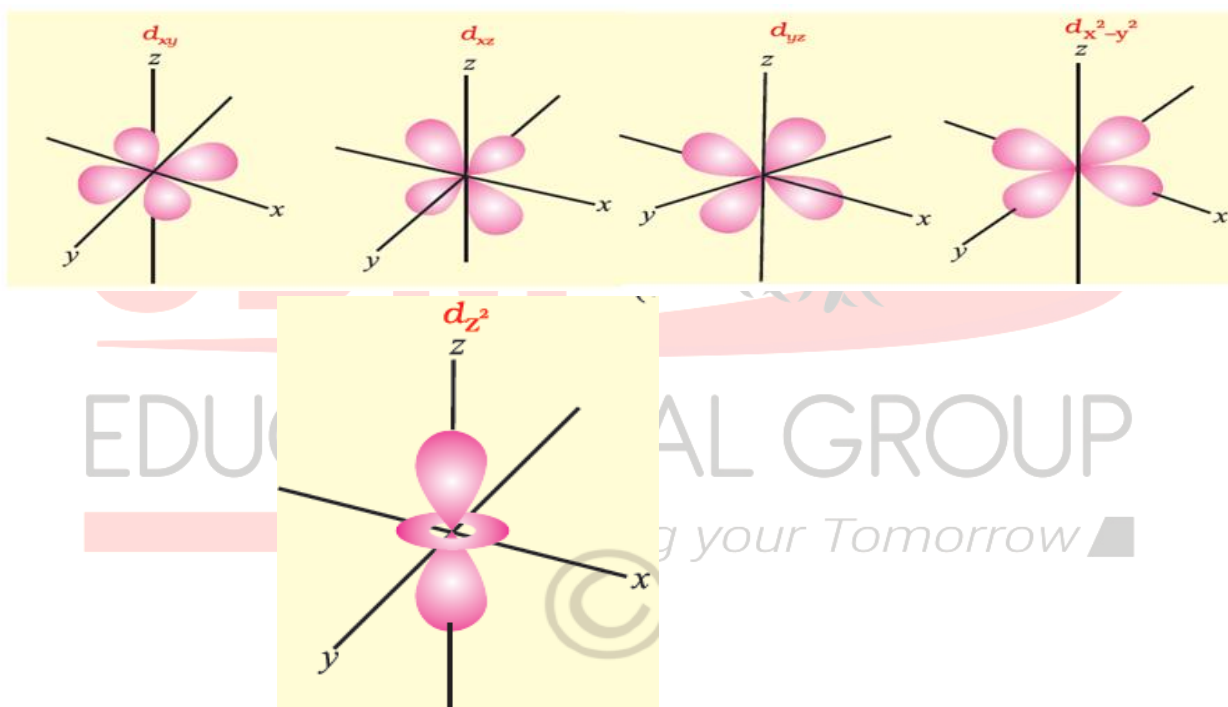

Angular node:

The probability density functions for the np and nd orbitals are zero at the plane (s), passing through the nucleus (origin). **For example**, in case of P_z orbital, xy -plane is a nodal plane, in case of d_{xy} orbital, there are two nodal planes passing through the origin and bisecting the xy plane containing z -axis. These are called **angular nodes** and number of angular nodes are given by ' l ' i.e., one angular node for p orbitals, two angular nodes for 'd' orbitals and so on. The total number of nodes are given by $(n-1)$, i.e., sum of angular nodes and $(n - l - 1)$ radial nodes.

Energies of Orbitals

The energy of an electron in a hydrogen atom is determined by the principal quantum number. Thus the energy of the orbitals increases as follows : $1s < 2s = 2p < 3s = 3p = 3d < 4s = 4p = 4d = 4f <$

Although the shapes of 2s and 2p orbitals are different, an electron has the same energy when it is in the 2s orbital as when it is present in 2p orbital. The orbitals having the same energy are called **degenerate**.

The energy of an electron in a multielectron atom, depends not only on its principal quantum number (shell), but also on its azimuthal quantum number (subshell). That is, for a given principal quantum number, s, p, d, f ... all have different energies. The main reason for having different energies of the subshells is the mutual repulsion among the electrons in a multi-electron atoms.

The stability of an electron in multi-electron atom is because total attractive interactions are more than the repulsive interactions. The attractive interactions of an electron increases with increase of positive charge (Ze) on the nucleus. Due to the presence of electrons in the inner shells, the electron in the outer shell will not experience the full positive charge of the nucleus (Ze). The effect will be lowered due to the **partial screening** of positive charge on the nucleus by the inner shell electrons. This is known as the shielding of the outer shell electrons from the nucleus by the inner shell electrons, and the net positive charge experienced by the outer electrons is known as **effective nuclear charge** (Z_{eff}).

Despite the shielding of the outer electrons from the nucleus by the inner shell electrons, the attractive force experienced by the outer shell electrons increases with increase of nuclear charge. In other words, the energy of interaction between, the nucleus and electron (that is orbital energy) decreases (that is more negative) with the increase of atomic number (Z). S-orbital shields the outer electrons from the nucleus more effectively as compared to electrons present in p orbital. Similarly electrons present in p orbitals shield the outer electrons from the nucleus more than the electrons present in d orbitals, even though all these orbitals are present in the same shell.

s-orbital electron will be more tightly bound to the nucleus than p orbital electron which in turn will be better tightly bound than the d orbital electron. The energy of electrons in s orbital will be lower (more negative) than that of p orbital electron which will have less energy than that of d orbital electron and so on.

The energy of electron in an orbital, the values of n and l . Lower the value of $(n + l)$ for an orbital, the lower is its energy. If two orbitals have the same value of $(n + l)$, the orbital with lower value of n will have the lower energy.

Energies of the orbitals in the same subshell decrease with increase in the atomic number (Z_{eff}). For example, energy of 2s orbital of hydrogen atom is greater than that of 2s orbital of lithium and that of lithium is greater than that of sodium and so on, that is, $E_{2s}(H) > E_{2s}(Li) > E_{2s}(Na) > E_{2s}(K)$.

Aufbau Principle

The principle states: In the ground state of the atoms, **the orbitals are filled in order of their increasing energies.**

In other words, electrons first occupy the lowest energy orbital available to them and enter into higher energy orbitals only after the lower energy orbitals are filled. The order in which the energies of the orbitals increase and hence the order in which the orbitals are filled is as follows:

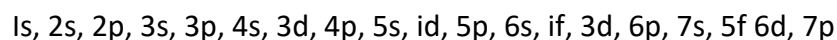

The energy of subshells can be determined by applying $(n + l)$ rule.

- (i) Higher is the $(n + l)$ value, higher is the energy of sub shell.

Ex: Between 3s and 3p, 3p has higher energy as its $(n + l)$ value is $3 + 1 = 4$ which is higher than 3s whose

$$n + l = 3 + 0 = 3$$

- (ii) If $(n + l)$ is same for both of the sub shell, then the sub shell having higher principal quantum number is said to be has higher energy.

Ex: Between 3p and 4s, 4s has higher energy as its $n + l = 4 + 0 = 4$

The order may be remembered by using the method given in fig

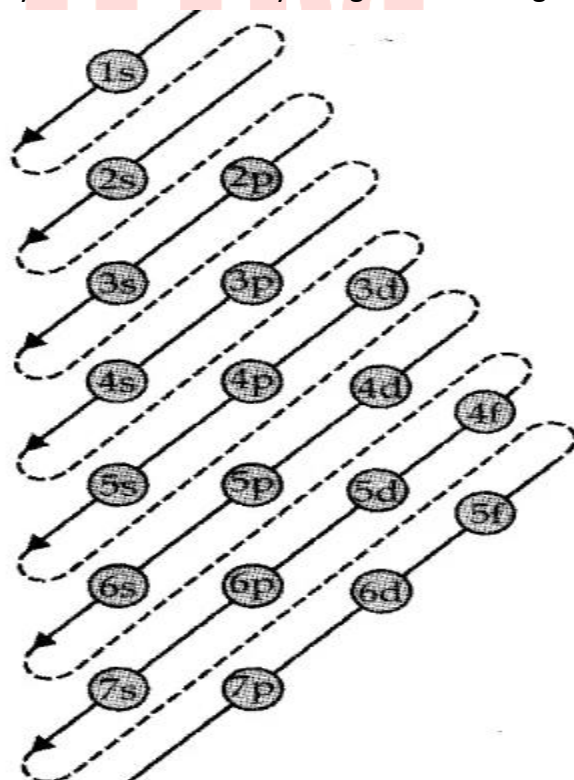

LECT-10

• Pauli Exclusion Principle

According to this principle, **no two electrons in an atom can have the same set of four quantum numbers.**

Pauli exclusion principle can also be stated as: Only two electrons may exist in the same orbital and these electrons must have opposite spins.

Pauli exclusion principle can also be stated as : **“Only two electrons may exist in the same orbital and these electrons must have opposite spin.”** This means that the two electrons can have the same value of three quantum numbers n , l and m_l , but must have the opposite spin quantum number.

The restriction imposed by Pauli’s exclusion principle on the number of electrons in an orbital helps in calculating the capacity of electrons to be present in any subshell. For example, subshell $1s$ comprises of one orbital and thus the maximum number of electrons present in $1s$ subshell can be two, in p and d subshells, the maximum number of electrons can be 6 and 10 and so on. This can be summed up as : the maximum number of electrons in the shell with principal quantum number n is equal to $2n^2$.

- **Hund’s Rule of Maximum Multiplicity**

It states that: pairing of electrons in the orbitals belonging to the same subshell (p , d or f) does not take place until each orbital belonging to that subshell has got one electron each i.e., it is singly occupied.

- **Electronic Configuration of Atoms**

The distribution of electrons into orbitals of an atom is called its electronic configuration. The electronic configuration of different atoms can be represented in two ways.

For example:

- (i) $s^a p^b d^c$ notation
 (ii) Orbital diagram

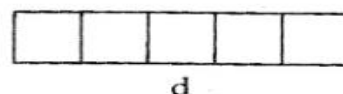
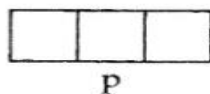

For example: The electronic configuration of hydrogen – $1s^1$.

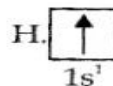

Li	$\uparrow\downarrow$	\uparrow			
Be	$\uparrow\downarrow$	$\uparrow\downarrow$			
B	$\uparrow\downarrow$	$\uparrow\downarrow$	\uparrow		
C	$\uparrow\downarrow$	$\downarrow\uparrow$	\uparrow	\uparrow	
N	$\uparrow\downarrow$	$\uparrow\downarrow$	\uparrow	\uparrow	\uparrow
O	$\uparrow\downarrow$	$\uparrow\downarrow$	$\uparrow\downarrow$	\uparrow	\uparrow
F	$\uparrow\downarrow$	$\uparrow\downarrow$	$\uparrow\downarrow$	$\uparrow\downarrow$	\uparrow
Ne	$\uparrow\downarrow$	$\uparrow\downarrow$	$\uparrow\downarrow$	$\uparrow\downarrow$	$\uparrow\downarrow$
	1s	2s	2p		

• **Causes of Stability of Completely Filled and Half Filled Sub shells**

The completely filled and half filled sub shells are stable due to the following reasons:

1. **Symmetrical distribution of electrons:**

It is well known that symmetry leads to stability. The completely filled or half filled subshells have symmetrical distribution of electrons in them and are therefore more stable. Electrons in the same subshell (here 3d) have equal energy but different spatial distribution. Consequently, their shielding of one another is relatively small and the electrons are more strongly attracted by the nucleus.

2. **Exchange Energy :**

The stabilizing effect arises whenever two or more electrons with the same spin are present in the degenerate orbitals of a subshell. These electrons tend to exchange their positions and the energy released due to this exchange is called **exchange energy**. The number of exchanges that can take place is maximum when the subshell is either half filled or completely filled. As a result the exchange energy is maximum and so is the stability.

In other words, the extra stability of half-filled and completely filled subshell is due to: (i) relatively small shielding, (ii) smaller coulombic repulsion energy, and (iii) larger exchange energy.

Possible exchange for a d^5 configuration

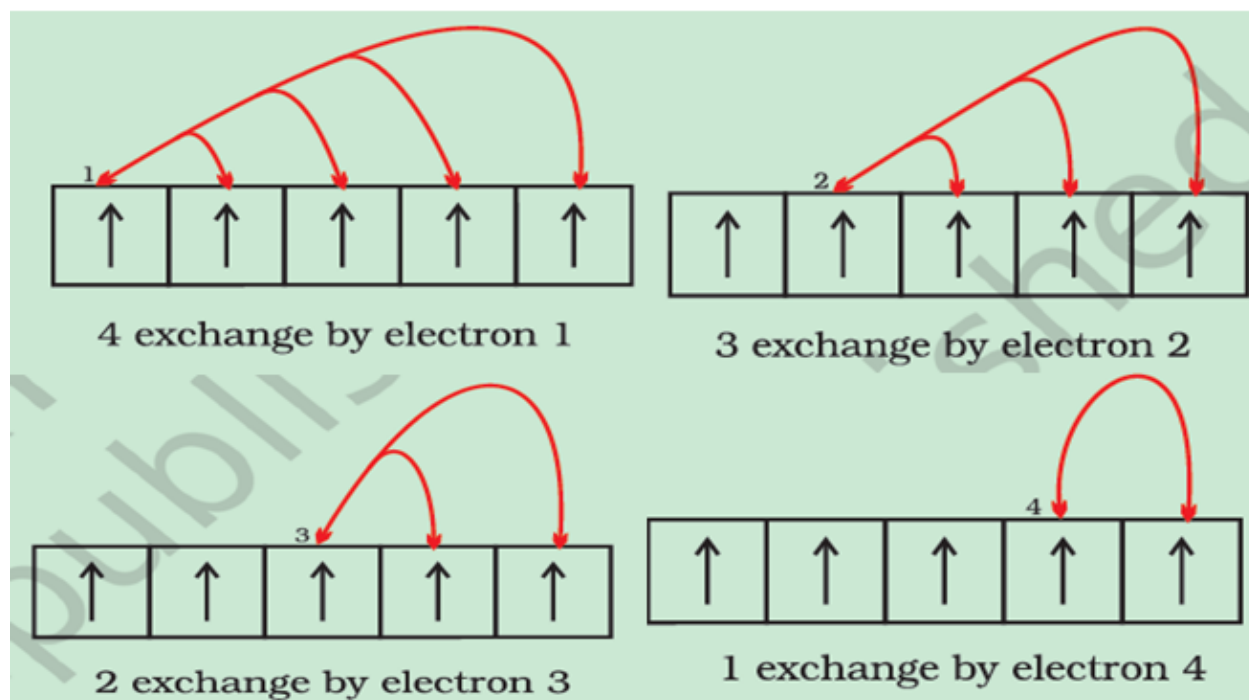

Electronic configuration of elements

Atomic Number	Name of the Element	Electronic Configuration
1	Hydrogen (H)	1s ¹
2	Helium (He)	1s ²
3	Lithium (Li)	[He] 2s ¹
4	Beryllium (Be)	[He] 2s ²
5	Boron (B)	[He] 2s ² 2p ¹
6	Carbon (C)	[He] 2s ² 2p ²
7	Nitrogen (N)	[He] 2s ² 2p ³
8	Oxygen (O)	[He] 2s ² 2p ⁴

9	Fluorine (F)	$[\text{He}] 2s^2 2p^5$
10	Neon (Ne)	$[\text{He}] 2s^2 2p^6$
11	Sodium (Na)	$[\text{Ne}] 3s^1$
12	Magnesium (Mg)	$[\text{Ne}] 3s^2$
13	Aluminium (Al)	$[\text{Ne}] 3s^2 3p^1$
14	Silicon (Si)	$[\text{Ne}] 3s^2 3p^2$
15	Phosphorus (P)	$[\text{Ne}] 3s^2 3p^3$
16	Sulfur (S)	$[\text{Ne}] 3s^2 3p^4$
17	Chlorine (Cl)	$[\text{Ne}] 3s^2 3p^5$
18	Argon (Ar)	$[\text{Ne}] 3s^2 3p^6$
19	Potassium (K)	$[\text{Ar}] 4s^1$
20	Calcium (Ca)	$[\text{Ar}] 4s^2$
21	Scandium (Sc)	$[\text{Ar}] 3d^1 4s^2$
22	Titanium (Ti)	$[\text{Ar}] 3d^2 4s^2$
23	Vanadium (V)	$[\text{Ar}] 3d^3 4s^2$
24	Chromium (Cr)	$[\text{Ar}] 3d^5 4s^1$
25	Manganese (Mn)	$[\text{Ar}] 3d^5 4s^2$
26	Iron (Fe)	$[\text{Ar}] 3d^6 4s^2$
27	Cobalt (Co)	$[\text{Ar}] 3d^7 4s^2$
28	Nickel (Ni)	$[\text{Ar}] 3d^8 4s^2$
29	Copper (Cu)	$[\text{Ar}] 3d^{10} 4s^1$
30	Zinc (Zn)	$[\text{Ar}] 3d^{10} 4s^2$

