

$$= 2 \times (3+3) = 22 \text{ cm}$$

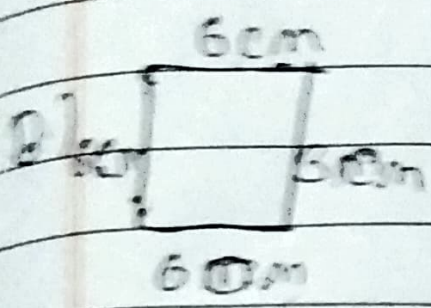

$$6 \times 6 = 36 \text{ cm}$$

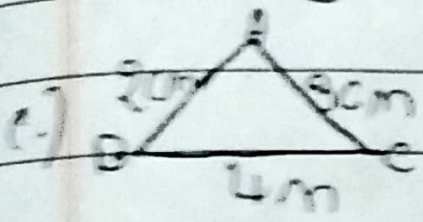

$$= 2 + 2 + 3 = 9 \text{ cm}$$

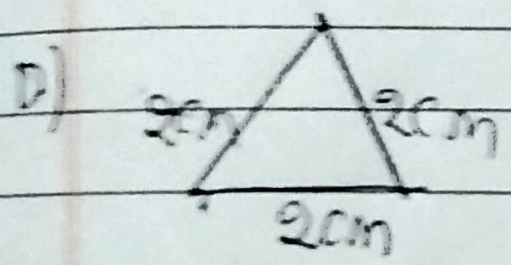

$$2 \times 2 + 2 = 6$$

E.)

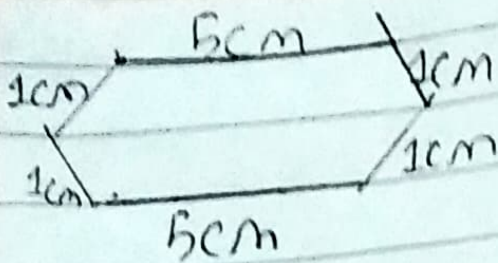

$$1+1+1+1+5+5=14\text{cm}$$

F.)

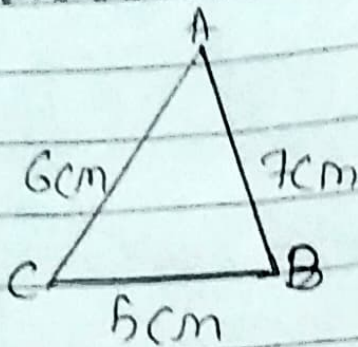

$$7+6+5=18$$

G.)

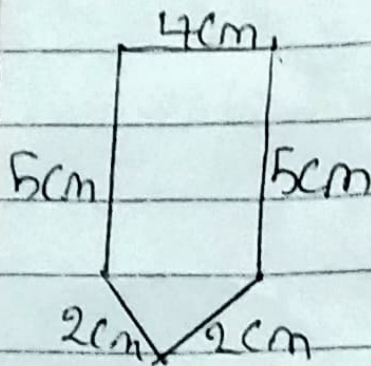

$$5 \times 5 \times 2 + 2 \times 4 = 26$$

H.)

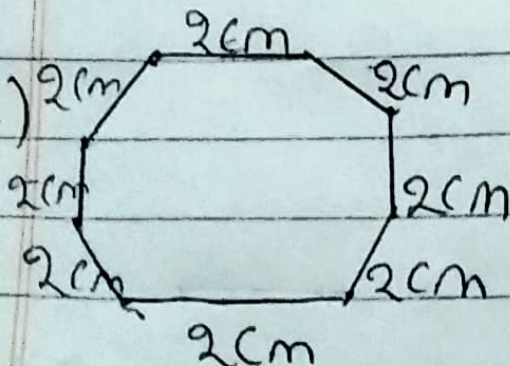

$$2 \times 2 \times 2 \times 2 + 2 + 2 + 2 + 2 = 24$$

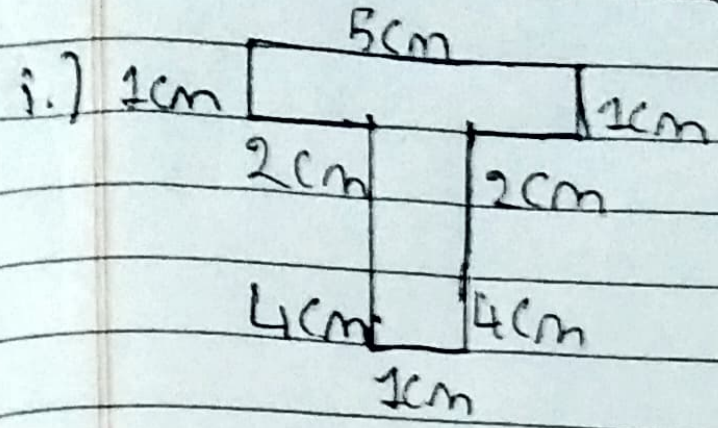

$$5 \times 4 \times 4 + 1 + 2 + 2 + 1 + 1 = 87$$

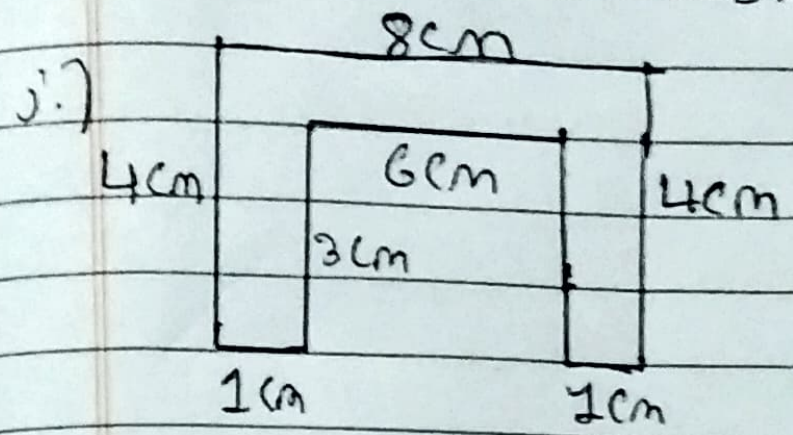

$$8 \times 4 + 6 + 3 + 1 + 1 + 4 = 47$$